

**NOTICE!!**

**These documents have been scanned!**

**Do not place un-scanned documents beneath this notice!**

**Do not remove this notice from this file!**

GPO Jacket No. 560-102  
Print Order 61540  
Rise Business Services, LLC  
Job=AZ15 6/3/2019



Box Number= AZ15113



Claim Begin-End: AMC366751-AMC366759

**1 Initial Receipt**



AZ15113-8

AMC366290-AMC366988

**United States Department of the Interior  
Bureau of Land Management**

BUSINESS & SUPPORT SVCS DIV  
222 N CENTRAL AVE  
PHOENIX, AZ 85004 -2203  
Phone: (602) 417-9200

Receipt	
No:	1120533

**Transaction #:** 1159445  
**Date of Transaction:** 08/02/2005

**CUSTOMER:** CONCENTRIC ENERGY CORP  
2905 GREENCASTLE RD  
BURTONSVILLE, MD 20866

ENTERED IN COMPUTER

82 8/12/05

LINE #	QTY	DESCRIPTION	REMARKS	UNIT PRICE	TOTAL
1	9.00	LOCATABLE MINERALS / MINING CLAIMS-NEW, UNADJUDI, ONE OR MORE AUTH NO'S / NEW MINING CLAIM LOCATION FEE \$30 (1993) <b>CASES:</b> AMC366752/\$30.00, AMC366751/\$30.00, AMC366753/\$30.00, AMC366754/\$30.00, AMC366755/\$30.00, AMC366756/\$30.00, AMC366757/\$30.00, AMC366758/\$30.00, AMC366759/\$30.00		- n/a -	270.00
2	9.00	LOCATABLE MINERALS / MINING CLAIMS-NEW, UNADJUDI, ONE OR MORE AUTH NO'S / NEW MINING CLAIM SVC CHG \$10 (1930) <b>CASES:</b> AMC366751/\$10.00, AMC366752/\$10.00, AMC366753/\$10.00, AMC366754/\$10.00, AMC366755/\$10.00, AMC366756/\$10.00, AMC366757/\$10.00, AMC366758/\$10.00, AMC366759/\$10.00		- n/a -	90.00
3	9.00	LOCATABLE MINERALS / MINING CLAIMS-NEW, UNADJUDI, ONE OR MORE AUTH NO'S / NEW MINING CLM MAINT FEE \$125 (1993) <b>CASES:</b> AMC366751/\$125.00, AMC366752/\$125.00, AMC366753/\$125.00, AMC366754/\$125.00, AMC366755/\$125.00, AMC366756/\$125.00, AMC366757/\$125.00, AMC366758/\$125.00, AMC366759/\$125.00		- n/a -	1125.00
<b>TOTAL:</b>					<b>\$1,485.00</b>

PAYMENT INFORMATION			
1	AMOUNT:	\$1,485.00	POSTMARKED: 07/29/2005
	TYPE:	CHECK	RECEIVED: 08/01/2005
	CHECK NO:	1288	
	NAME:	CONCENTRIC ENERGY CORP 2905 GREENCASTLE RD BURTONSVILLE MD 20866	

REMARKS

**United States Department of the Interior  
Bureau of Land Management**

BUSINESS & SUPPORT SVCS DIV  
222 N CENTRAL AVE  
PHOENIX, AZ 85004 -2203  
Phone: (602) 417-9200

Receipt	
No:	1120540

<b>Transaction #:</b> 1159452	
<b>Date of Transaction:</b> 08/02/2005	
CUSTOMER:	CONCENTRIC ENERGY CORP 2905 GREENCASTLE RD BURTONSVILLE,MD 20866

LINE #	QTY	DESCRIPTION	REMARKS	UNIT PRICE	TOTAL
1	1.00	LOCATABLE MINERALS / MINING CLAIMS-NOT NEW-UNADJUD,ONE AUTH NO. ONLY / MINING CLAIM MONEY RECEIVED (455) <b>CASES:</b> AMC366751/\$1125.00	MAINT 2006 - 9	- n/a -	1125.00
<b>TOTAL:</b>					<b>\$1,125.00</b>

PAYMENT INFORMATION				
1	AMOUNT:	\$1,125.00	POSTMARKED:	07/29/2005
	TYPE:	CHECK	RECEIVED:	08/01/2005
	CHECK NO:	1289		
	NAME:	CONCENTRIC ENERGY CORP 2905 GREENCASTLE RD BURTONSVILLE MD 20866		

REMARKS

This receipt was generated by the automated BLM Collections and Billing System and is a paper representation of a portion of the official electronic record contained therein.

**NOTICE!!**

**These documents have been scanned!**

**Do not place un-scanned documents beneath this notice!**

**Do not remove this notice from this file!**

GPO Jacket No. 560-102  
Print Order 61540  
Rise Business Services, LLC  
Job=AZ15 6/3/2019



Box Number= AZ15113



Claim Begin-End: AMC366751-AMC366759

**2 Correspondence**



AZ15113-8

AMC366290-AMC366988

**NO  
DOCUMENTS  
FOUND**

NO DOCUMENTS FOUND  
NO DOCUMENTS FOUND

**NOTICE!!**

**These documents have been scanned!**

**Do not place un-scanned documents beneath this notice!**

**Do not remove this notice from this file!**

GPO Jacket No. 560-102  
Print Order 61540  
Rise Business Services, LLC  
Job=AZ15 6/3/2019



Box Number= AZ15113



Claim Begin-End: AMC366751-AMC366759

**3 Transfers**



AZ15113-8

AMC366290-AMC366988

**NO  
DOCUMENTS  
FOUND**

NO DOCUMENTS FOUND  
NO DOCUMENTS FOUND

**NOTICE!!**

**These documents have been scanned!**

**Do not place un-scanned documents beneath this notice!**

**Do not remove this notice from this file!**

GPO Jacket No. 560-102  
Print Order 61540  
Rise Business Services, LLC  
Job=AZ15 6/3/2019



Box Number= AZ15113



Claim Begin-End: AMC366751-AMC366759

**4 Annual Filings**



AZ15113-8

AMC366290-AMC366988





403601  
407697

361520  
388128  
365258  
366483

394954  
414006  
416412

393473  
410884  
366751

CERTIFIED MAIL

August 6, 2018

7016 0600 0000 3466 1912

Bureau of Land Management  
One North Central Avenue, Suite 800  
Phoenix, AZ 85004-4427

RECEIVED  
BLM AZ STATE OFFICE  
2018 AUG 13 P 2:19  
PHOENIX, ARIZONA

To Whom It May Concern:

Please find attached our Assessment Fees for our mining claims as defined on the attached list of claims. Also attached is our filing fee of \$90,520.00 for 584 mining claims, check number 20482, and a self-addressed stamped envelope for your use in returning a copy of your receipt notice.

Please contact our land department at (512) 450-4480 if you have any questions.

Regards,

Leonard G. Garcia  
Manager, Land

Attachments

500 N. Shoreline Blvd. Suite 800N. Corpus Christi, TX 78401  
Tel: 361-888-8235 Fax: 361-888-5041

# 4235165  
ENTERED  
AUG 17 2018  
BY: Ram (12)

# ARIZONA

Claim Name	BLM #	Township	Range	Section
AM 1	AMC361520	11N	10W	15, 16
AM 2	AMC361521	11N	10W	15
AM 3	AMC361522	11N	10W	15, 16
AM 4	AMC361523	11N	10W	15
AM 5	AMC361524	11N	10W	15, 16
AM 6	AMC361525	11N	10W	15
AM 7	AMC361526	11N	10W	15, 16
AM 8	AMC361527	11N	10W	15, 22
AM 9	AMC361528	11N	10W	15, 16
AM 10	AMC361529	11N	10W	15, 22
AM 11	AMC361530	11N	10W	15, 16, 21, 22
AM 12	AMC361531	11N	10W	22
AM 13	AMC361532	11N	10W	21, 22
AM 14	AMC361533	11N	10W	21, 22
AM 15	AMC361534	11N	10W	21, 22
AM 16	AMC361535	11N	10W	21, 22
AM 17	AMC361536	11N	10W	21
AM 18	AMC361537	11N	10W	21, 22
AM 19	AMC361538	11N	10W	21
AM 20	AMC361539	11N	10W	21, 22
AM 21	AMC361540	11N	10W	21
AM 22	AMC361541	11N	10W	21, 22
AM 23	AMC361542	11N	10W	21
AM 24	AMC361543	11N	10W	21, 22
AM 25	AMC361544	11N	10W	15, 22
AM 26	AMC361545	11N	10W	22
AM 27	AMC361546	11N	10W	22
AM 28	AMC361547	11N	10W	22
AM 29	AMC361548	11N	10W	22
AM 30	AMC361549	11N	10W	22
AM 31	AMC361550	11N	10W	22
AM 32	AMC361551	11N	10W	22
AM 33	AMC361552	11N	10W	22
AM 34	AMC361553	11N	10W	22
AM 35	AMC361554	11N	10W	22
AM 36	AMC361555	11N	10W	22
AM 37	AMC361556	11N	10W	22
AM 38	AMC361557	11N	10W	22
AM 39	AMC361558	11N	10W	22
AM 40	AMC361559	11N	10W	22, 27
AM 41	AMC361560	11N	10W	22
AM 42	AMC361561	11N	10W	22, 27
AM 43	AMC361562	11N	10W	22, 27

RECEIVED  
 BLM AZ STATE OFFICE  
 2018 AUG 13 P 2:20  
 PHOENIX, ARIZONA

AM 44	AMC361563	11N	10W	27
AM 45	AMC361564	11N	10W	27
AM 46	AMC361565	11N	10W	11
AM 47	AMC361566	11N	10W	11
AM 48	AMC361567	11N	10W	11, 14
AM 49	AMC361568	11N	10W	11
AM 50	AMC361569	11N	10W	11, 14
AM 51	AMC361570	11N	10W	11, 14
AM 52	AMC361571	11N	10W	14
AM 53	AMC361572	11N	10W	11, 14
AM 54	AMC361573	11N	10W	14
AM 55	AMC361574	11N	10W	14
AM 56	AMC361575	11N	10W	14
AM 57	AMC361576	11N	10W	14
AM 58	AMC361577	11N	10W	14
AM 59	AMC361578	11N	10W	14
AM 60	AMC361579	11N	10W	14
AM 61	AMC361580	11N	10W	14
AM 62	AMC361581	11N	10W	14
AM 63	AMC361582	11N	10W	14
AM 64	AMC361583	11N	10W	14
AM 65	AMC361584	11N	10W	14
AM 66	AMC361585	11N	10W	14
AM 67	AMC361586	11N	10W	14, 15
AM 68	AMC361587	11N	10W	14, 23
AM 69	AMC361588	11N	10W	14, 15, 23
AM 70	AMC361589	11N	10W	23
AM 71	AMC361590	11N	10W	14, 15, 22, 23
AM 72	AMC361591	11N	10W	23
AM 73	AMC361592	11N	10W	22, 23
AM 74	AMC361593	11N	10W	23
AM 75	AMC361594	11N	10W	22, 23
AM 76	AMC361595	11N	10W	23
AM 77	AMC361596	11N	10W	22, 23
AM 78	AMC361597	11N	10W	23
AM 79	AMC361598	11N	10W	22, 23
AM 80	AMC361599	11N	10W	23
AM 81	AMC361600	11N	10W	22, 23
AM 82	AMC361601	11N	10W	23
AM 83	AMC361602	11N	10W	23
AM 84	AMC361603	11N	10W	23
AM 85	AMC361604	11N	10W	22, 23
AM 86	AMC361605	11N	10W	22, 23, 26, 27
AM 87	AMC361606	11N	10W	22, 27
AM 88	AMC361607	11N	10W	26, 27
AM 89	AMC361608	11N	10W	22, 27
AM 90	AMC361609	11N	10W	26, 27

PHOENIX, ARIZONA

2018 AUG 13 P 2:20

RECEIVED  
BLM AZ STATE OFFICE

AM 91	AMC361610	11N	10W	27
AM 92	AMC361611	11N	10W	26, 27
AM 93	AMC361612	11N	10W	27
AM 94	AMC361613	11N	10W	26, 27
AM 95	AMC361614	11N	10W	27
AM 96	AMC361615	11N	10W	26, 27
AM 97	AMC361616	11N	10W	27
AM 98	AMC361617	11N	10W	26, 27
AM 99	AMC361618	11N	10W	27
AM 100	AMC361619	11N	10W	26, 27
AM 101	AMC361620	11N	10W	27
AM 102	AMC361621	11N	10W	26, 27
AM 103	AMC361622	11N	10W	27
AM 104	AMC361623	11N	10W	26, 27, 34
AM 105	AMC361624	11N	10W	11, 12
AM 106	AMC361625	11N	10W	12, 13
AM 107	AMC361626	11N	10W	11, 12, 13, 14
AM 108	AMC361627	11N	10W	12, 13
AM 109	AMC361628	11N	10W	13, 14
AM 110	AMC361629	11N	10W	13
AM 111	AMC361630	11N	10W	13, 14
AM 112	AMC361631	11N	10W	13
AM 113	AMC361632	11N	10W	13, 14
AM 114	AMC361633	11N	10W	13
AM 115	AMC361634	11N	10W	13, 14
AM 116	AMC361635	11N	10W	13, 14
AM 117	AMC361636	11N	10W	14
AM 118	AMC361637	11N	10W	13, 14
AM 119	AMC361638	11N	10W	14
AM 120	AMC361639	11N	10W	13, 14
AM 121	AMC361640	11N	10W	14
AM 122	AMC361641	11N	10W	13, 14
AM 123	AMC361642	11N	10W	14
AM 124	AMC361643	11N	10W	13, 14, 24
AM 125	AMC361644	11N	10W	14, 23
AM 126	AMC361645	11N	10W	13, 14, 24
AM 127	AMC361646	11N	10W	23
AM 128	AMC361647	11N	10W	23, 24
AM 129	AMC361648	11N	10W	23
AM 130	AMC361649	11N	10W	23, 24
AM 131	AMC361650	11N	10W	23
AM 132	AMC361651	11N	10W	23, 24
AM 133	AMC361652	11N	10W	23
AM 134	AMC361653	11N	10W	23
AM 135	AMC361654	11N	10W	23
AM 136	AMC361655	11N	10W	23
AM 137	AMC361656	11N	10W	23

RECEIVED  
BLM AZ STATE OFFICE  
2018 AUG 13 P 2:20  
PHOENIX, ARIZONA

AM 138	AMC361657	7 11N	10W	23
AM 139	AMC361658	11N	10W	23
AM 140	AMC361659	11N	10W	23
AM 141	AMC361660	11N	10W	23
AM 142	AMC361661	11N	10W	23, 26
AM 143	AMC361662	11N	10W	23, 26
AM 144	AMC361663	11N	10W	23, 26
AM 145	AMC361664	11N	10W	23, 26
AM 146	AMC361665	11N	10W	26
AM 147	AMC361666	11N	10W	26
AM 148	AMC361667	11N	10W	26
AM 149	AMC361668	11N	10W	26
AM 150	AMC361669	11N	10W	26
AM 151	AMC361670	11N	10W	26
AM 152	AMC361671	11N	10W	26
AM 153	AMC361672	11N	10W	26
AM 154	AMC361673	11N	10W	26
AM 155	AMC361674	11N	10W	26
AM 156	AMC361675	11N	10W	26
AM 157	AMC361676	11N	10W	26
AM 158	AMC361677	11N	10W	26
AM 159	AMC361678	11N	10W	26
AM 160	AMC361679	11N	10W	26, 35
AM 161	AMC361680	11N	10W	26, 35
AM 162	AMC361681	11N	10W	26, 35
AM 163	AMC361682	11N	10W	12, 13
AM 164	AMC361683	11N	10W	13
AM 165	AMC361684	11N	10W	13
AM 166	AMC361685	11N	10W	13
AM 167	AMC361686	11N	10W	13
AM 168	AMC361687	11N	10W	13
AM 169	AMC361688	11N	10W	13
AM 170	AMC361689	11N	10W	13
AM 171	AMC361690	11N	10W	13
AM 172	AMC361691	11N	10W	13
AM 173	AMC361692	11N	10W	13
AM 174	AMC361693	11N	10W	13
AM 175	AMC361694	11N	10W	13
AM 176	AMC361695	11N	10W	13
AM 177	AMC361696	11N	10W	13
AM 178	AMC361697	11N	10W	13
AM 179	AMC361698	11N	10W	13
AM 180	AMC361699	11N	10W	13, 24
AM 181	AMC361700	11N	10W	13, 24
AM 182	AMC361701	11N	10W	24
AM 183	AMC361702	11N	10W	24
AM 184	AMC361703	11N	10W	24

RECEIVED  
BLM AZ STATE OFFICE  
2018 AUG 13 P 2:20  
PHOENIX, ARIZONA

AM 185	AMC361704	11N	10W	24
AM 186	AMC361705	11N	10W	24
AM 187	AMC361706	11N	10W	24
AM 188	AMC361707	11N	10W	24
AM 189	AMC361708	11N	10W	24
AM 190	AMC361709	11N	10W	24
AM 191	AMC361710	11N	10W	23, 24
AM 192	AMC361711	11N	10W	24
AM 193	AMC361712	11N	10W	23, 24
AM 194	AMC361713	11N	10W	24
AM 195	AMC361714	11N	10W	23, 24
AM 196	AMC361715	11N	10W	24
AM 197	AMC361716	11N	10W	23, 24
AM 198	AMC361717	11N	10W	24, 25
AM 199	AMC361718	11N	10W	23, 24, 25, 26
AM 200	AMC361719	11N	10W	24, 25
AM 201	AMC361720	11N	10W	25, 26
AM 202	AMC361721	11N	10W	25
AM 203	AMC361722	11N	10W	25, 26
AM 204	AMC361723	11N	10W	25
AM 205	AMC361724	11N	10W	25, 26
AM 206	AMC361725	11N	10W	25
AM 207	AMC361726	11N	10W	25, 26
AM 208	AMC361727	11N	10W	25
AM 209	AMC361728	11N	10W	25, 26
AM 210	AMC361729	11N	10W	25, 26
AM 211	AMC361730	11N	10W	25, 26
AM 212	AMC361731	11N	10W	25, 26
AM 213	AMC361732	11N	10W	25, 26
AM 214	AMC361733	11N	10W	25, 26
AM 215	AMC361734	11N	10W	25, 26
AM 216	AMC361735	11N	10W	25, 26, 36
AM 217	AMC388128	11N	10W	9, 10
AM 218	AMC388129	11N	10W	9, 10
AM 219	AMC388130	11N	10W	9, 10
AM 220	AMC388131	11N	10W	10
AM 221	AMC388132	11N	10W	10
AM 222	AMC388133	11N	10W	10
AM 223	AMC388134	11N	10W	3, 10
AM 224	AMC388135	11N	10W	10
AM 225	AMC388136	11N	10W	3
AM 226	AMC388137	11N	10W	3
AM 227	AMC388138	11N	10W	3
AM 228	AMC388139	11N	10W	3
AM 229	AMC388140	11N	10W	3
AM 230	AMC388141	11N	10W	3
AM 231	AMC388142	11N	10W	10, 11

PHOENIX, ARIZONA

2018 AUG 13 P 2:20

RECEIVED  
BLM AT STATE OFFICE

AM 232	AMC388143	11N	10W	11
AM 233	AMC388144	11N	10W	10, 11
AM 234	AMC388145	11N	10W	11
AM 235	AMC388146	11N	10W	2, 3, 10, 11
AM 236	AMC388147	11N	10W	11
AM 237	AMC388148	11N	10W	2, 3, 11
AM 238	AMC388149	11N	10W	2, 11
AM 239	AMC388150	11N	10W	11
AM 240	AMC388151	11N	10W	11
AM 241	AMC388152	11N	10W	11
AM 242	AMC388153	11N	10W	11
AM 243	AMC388154	11N	10W	11
AM 244	AMC388155	11N	10W	11
AM 245	AMC388156	11N	10W	11
AM 246	AMC361736	11N	10W	10
AM 247	AMC361737	11N	10W	10
AM 248	AMC361738	11N	10W	10,11
AM 249	AMC361739	11N	10W	11
AM 250	AMC361740	11N	10W	11
AM 251	AMC361741	11N	10W	11
AM 252	AMC361742	11N	10W	11
AM 253	AMC361743	11N	10W	11
AM 254	AMC361744	11N	10W	9, 15, 16
AM 255	AMC361745	11N	10W	9, 16
AM 256	AMC361746	11N	10W	9, 10, 15
AM 257	AMC361747	11N	10W	9
AM 258	AMC361748	11N	10W	9, 10
AM 259	AMC361749	11N	10W	9
AM 260	AMC361750	11N	10W	9, 10
AM 261	AMC361751	11N	10W	9
AM 262	AMC361752	11N	10W	9, 10
AM 263	AMC361753	11N	10W	9
AM 264	AMC361754	11N	10W	27, 34
AM 265	AMC365258	11N	10W	10, 11
AM 266	AMC365259	11N	10W	11
AM 267	AMC365260	11N	10W	10, 11
AM 268	AMC365261	11N	10W	10, 11
AM 269	AMC365262	11N	10W	10, 11
AM 270	AMC365263	11N	10W	10, 11
AM 271	AMC365264	11N	10W	10, 11, 15
AM 272	AMC365265	11N	10W	10, 11, 14, 15
AM 273	AMC365266	11N	10W	10, 15
AM 274	AMC365267	11N	10W	14, 15
AM 275	AMC365268	11N	10W	15
AM 276	AMC365269	11N	10W	14, 15
AM 277	AMC365270	11N	10W	15
AM 278	AMC365271	11N	10W	14, 15

RECEIVED  
BLM AZ STATE OFFICE  
2018 AUG 13 P 2:20  
PHOENIX, ARIZONA

AM 279	AMC365272	11N	10W	15
AM 280	AMC365273	11N	10W	14, 15
AM 281	AMC365274	11N	10W	15
AM 282	AMC365275	11N	10W	14, 15
AM 283	AMC365276	11N	10W	15
AM 284	AMC365277	11N	10W	14, 15
AM 285	AMC365278	11N	10W	15
AM 286	AMC365279	11N	10W	14, 15
AM 287	AMC365280	11N	10W	10
AM 288	AMC365281	11N	10W	10
AM 289	AMC365282	11N	10W	10
AM 290	AMC365283	11N	10W	10
AM 291	AMC365284	11N	10W	10
AM 292	AMC365285	11N	10W	10, 15
AM 293	AMC365286	11N	10W	10, 15
AM 294	AMC365287	11N	10W	10, 15
AM 295	AMC365288	11N	10W	15
AM 296	AMC365289	11N	10W	15
AM 297	AMC365290	11N	10W	15, 16
AM 298	AMC365291	11N	10W	15
AM 299	AMC365292	11N	10W	15, 16
AM 300	AMC365293	11N	10W	15
AM 301	AMC365294	11N	10W	15
AM 302	AMC366483	11N	10W	9, 10
AM 303	AMC366484	11N	10W	10
AM 304	AMC366485	11N	10W	10
AM 305	AMC366486	11N	10W	10
AM 306	AMC366487	11N	10W	10
AM 307	AMC366488	11N	10W	10
AM 308	AMC366489	11N	10W	10, 11
AM 309	AMC366490	11N	10W	11
AM 310	AMC388157	11N	10W	11, 12
AM 311	AMC388158	11N	10W	2, 11
AM 312	AMC388159	11N	10W	2, 11, 12
AM 313	AMC388160	11N	10W	1, 2, 11, 12
AM 314	AMC388161	11N	10W	12
AM 315	AMC388162	11N	10W	12
AM 316	AMC388163	11N	10W	12
AM 317	AMC388164	11N	10W	11, 12
AM 318	AMC388165	11N	10W	12
AM 319	AMC388166	11N	10W	11, 12
AM 320	AMC388167	11N	10W	12
AM 321	AMC388168	11N	10W	11, 12
AM 322	AMC388169	11N	10W	12
AM 323	AMC388170	11N	10W	11, 12
AM 324	AMC388171	11N	10W	12
AM 325	AMC388172	11N	10W	13

RECEIVED  
BLM AZ STATE OFFICE  
2018 AUG 13 P 2:20  
PHOENIX, ARIZONA



AM 326	AMC388173	11N	10W	13
AM 327	AMC388174	11N	9W/10W	18/13
AM 328	AMC388175	11N	9W/10W	18, 19/13, 24
AM 329	AMC388176	11N	9W	18, 19
AM 330	AMC388177	11N	10W	13, 24
AM 331	AMC388178	11N	9W/10W	19/ 24
AM 332	AMC388179	11N	10W	24
AM 333	AMC388180	11N	9W/10W	19/ 24
AM 334	AMC388181	11N	10W	24
AM 335	AMC388182	11N	9W/10W	19/ 24
AM 336	AMC388183	11N	10W	24
AM 337	AMC388184	11N	9W/10W	19/ 24
AM 338	AMC388185	11N	10W	24
AM 339	AMC388186	11N	9W/10W	19/ 24
AM 340	AMC388187	11N	10W	24
AM 341	AMC388188	11N	9W/10W	19/ 24
AM 342	AMC388189	11N	10W	24
AM 343	AMC388190	11N	9W/10W	19/ 24
AM 344	AMC388191	11N	10W	24
AM 345	AMC388192	11N	9W/10W	19/ 24
AM 346	AMC388193	11N	10W	24, 25
AM 347	AMC388194	11N	9W/10W	19, 30/24, 25
AM 348	AMC388195	11N	10W	24, 25
AM 349	AMC388196	11N	10W	25
AM 350	AMC388197	11N	10W	25
AM 351	AMC388198	11N	10W	25
AM 352	AMC388199	11N	10W	25
AM 353	AMC388200	11N	10W	25
AM 354	AMC388201	11N	10W	25
AM 355	AMC388202	11N	10W	25
AM 356	AMC388203	11N	10W	25
AM 357	AMC388204	11N	10W	25
AM 358	AMC393473	11N	10W	21
AM 359	AMC393474	11N	10W	21
AM 360	AMC393475	11N	10W	21
AM 361	AMC393476	11N	10W	21
AP 9	AMC410892	11N	10W	9
AP 10	AMC410893	11N	10W	9
AP 11	AMC410894	11N	10W	9
AP 12	AMC410895	11N	10W	9
AP 13	AMC410896	11N	10W	9
AP 14	AMC410897	11N	10W	9
AP 15	AMC410898	11N	10W	9
AP 16	AMC410899	11N	10W	9
AP 17	AMC410900	11N	10W	9, 16
AP 18	AMC410901	11N	10W	9, 16
AP 22	AMC410905	11N	10W	9, 10

RECEIVED  
 BLM AZ STATE OFFICE  
 2018 AUG 13 P 2:20  
 PHOENIX, ARIZONA

AP 24	AMC410907	← 11N	10W	9, 10
AP 26	AMC410909	7 11N	10W	9, 10
AP 27	AMC410910	11N	10W	9
AP 28	AMC410911	11N	10W	9, 10
AP 30	AMC410913	← 11N	10W	10
CE 1	AMC366751	11N	10W	11
CE 2	AMC366752	11N	10W	11
CE 3	AMC366753	11N	10W	11
CE 4	AMC366754	11N	10W	11
CE 5	AMC366755	11N	10W	11
CE 6	AMC366756	11N	10W	11
CE 7	AMC366757	11N	10W	11
CE 8	AMC366758	11N	10W	10
TH 1	AMC366759	11N	10W	10
Bak 1	AMC403601	7 6N	14E	20
Bak 2	AMC403602	6N	14E	20
Bak 3	AMC403603	6N	14E	20
Bak 4	AMC403604	6N	14E	20
Bak 5	AMC403605	6N	14E	20
Bak 6	AMC403606	6N	14E	29
Bak 7	AMC403607	6N	14E	29
Bak 8	AMC403608	6N	14E	29
Bak 9	AMC403609	6N	14E	29
Bak 10	AMC403610	6N	14E	20
CS 1	AMC407697	6N	14E	19
CS 2	AMC407698	6N	14E	19
CS 3	AMC407699	6N	14E	19
CS 4	AMC407700	6N	14E	19, 20
CS 5	AMC407701	6N	14E	20
CS 6	AMC407702	6N	14E	20
CS 7	AMC407703	6N	14E	20
CS 8	AMC407704	6N	14E	20
CS 9	AMC407705	6N	14E	20
CS 10	AMC407706	6N	14E	20
CS 11	AMC407707	6N	14E	20
CS 12	AMC407708	6N	14E	20
CS 13	AMC407709	6N	14E	19, 20
CS 14	AMC407710	6N	14E	19
CS 15	AMC407711	6N	14E	19
CS 16	AMC407712	6N	14E	19
CS 17	AMC407713	6N	14E	19
CS 18	AMC407714	6N	14E	19
CS 19	AMC407715	6N	14E	19, 20
CS 20	AMC407716	6N	14E	20
CS 21	AMC407717	6N	14E	20
CS 22	AMC407718	6N	14E	20
CS 23	AMC407719	6N	14E	20

RECEIVED  
BLM AZ STATE OFFICE  
2018 AUG 13 P 2:20  
PHOENIX, ARIZONA

CS 24	AMC407720	6N	14E	20, 29
CS 25	AMC407721	6N	14E	20, 29
CS 26	AMC407722	6N	14E	20, 29
CS 27	AMC407723	6N	14E	18
CS 28	AMC407724	6N	14E	18
CS 29	AMC407725	6N	14E	18
CS 30	AMC407726	6N	14E	18
CS 31	AMC407727	6N	14E	19
Oak 1	AMC403611	5N	14E	28
Oak 2	AMC403612	5N	14E	28
Oak 3	AMC403613	5N	14E	28
Oak 4	AMC403614	5N	14E	27
Oak 5	AMC403615	5N	14E	27
Oak 6	AMC403616	5N	14E	27
Oak 7	AMC403617	5N	14E	27
Oak 8	AMC403618	5N	14E	27
Oak 9	AMC403619	5N	14E	28
Oak 10	AMC403620	5N	14E	28
Pen 1	AMC403621	7N	14E	2, 11
Pen 2	AMC403622	7N	14E	2, 1, 11, 12
Pen 3	AMC403623	7N	14E	1, 12
Pen 4	AMC403624	7N	14E	1, 12
Pen 5	AMC403625	7N	14E	1, 12
Pen 6	AMC403626	7N	14E	1, 12
Pen 7	AMC403627	7N	14E	1, 12
Pen 9	AMC403628	7N	14E	1, 12
Pen 10	AMC403629	7N	14E	12
Pen 11	AMC403630	7N	14E	12
Pen 12	AMC403631	7N	14E	12
Pen 13	AMC403632	7N	14E	12
Pen 14	AMC403633	7N	14E	12
Pen 15	AMC403634	7N	14E	12
Pen 16	AMC403635	7N	14E	11, 12
Pen 17	AMC403636	7N	14E	12
Pen 18	AMC403637	7N	14E	12
Pen 19	AMC403638	7N	14E	12
Pen 20	AMC403639	7N	14E	12
Pen 21	AMC403640	7N	14E	12
Pen 22	AMC403641	7N	14E	12
Pen 23	AMC403642	7N	14E	12
Pen 24	AMC403643	7N	14E	12
Pen 25	AMC403644	7N	14E	12
Pen 26	AMC403645	7N	14E	12
Pen 27	AMC403646	7N	14E	12
Pen 28	AMC403647	7N	14E	12
Pen 29	AMC403648	7N	14E	12
Pen 30	AMC403649	7N	14E	11, 12

RECEIVED  
 BLM AZ STAFF OFFICE  
 2018 AUG 13 P 2:20  
 PHOENIX, ARIZONA

Pen 31	AMC403650	7N	14E	11
Pen 32	AMC403651	7N	14E	11, 14
Pen 33	AMC403652	7N	14E	11, 14, 12, 13
Pen 34	AMC403653	7N	14E	12, 13
Pen 35	AMC403654	7N	14E	12, 13
Pen 36	AMC403655	7N	14E	12, 13
Pen 37	AMC403656	7N	14E	12, 13
Pen 38	AMC403657	7N	14E	12, 13
RC 10	AMC394981	6N	14E	17
RC 11	AMC394982	6N	14E	17
RC 12	AMC394983	6N	14E	17
RC 13	AMC394984	6N	14E	17
RC 14	AMC394985	6N	14E	17
RC 15	AMC394986	6N	14E	18
RC 16	AMC394987	6N	14E	18
RC 17	AMC394988	6N	14E	18
RC 18	AMC394989	6N	14E	18
RC 19	AMC394990	6N	14E	18
RC 20	AMC394991	6N	14E	18
RC 21	AMC394992	6N	14E	17
RC 22	AMC394993	6N	14E	17
RC 23	AMC394994	6N	14E	17
RC 24	AMC394995	6N	14E	17
WC 62	AMC414006	6N	14E	18, 19
WC 63	AMC414007	6N	14E	19
WC 64	AMC414008	6N	14E	19
WC 65	AMC414009	6N	14E	19, 20, 29
WC 66	AMC416412	T6N	R14E	18, 19
WC 67	AMC416413	T6N	R14E	18, 19
WC 68	AMC416414	T6N	R14E	18, 19
WC 69	AMC416415	T6N	R13E	24
WC 70	AMC416416	T6N	R13E	24
WC 71	AMC416417	T6N	R13/14E	24/19
WC 72	AMC416418	T6N	R13/14E	24/19
WC 73	AMC416419	T6N	R14E	19
WC 74	AMC416420	T6N	R14E	19
WC 75	AMC416421	T6N	R14E	19
WC 76	AMC416422	T6N	R14E	19
WC 77	AMC416423	T6N	R14E	19
WC 78	AMC416424	T6N	R14E	19
WC 79	AMC416425	T6N	R14E	19
WC 80	AMC416426	T6N	R14E	19
WC 81	AMC416427	T6N	R14E	19
WC 82	AMC416428	T6N	R14E	19
WC 83	AMC416429	T6N	R14E	19, 30
WC 84	AMC416430	T6N	R14E	19
WC 85	AMC416431	T6N	R14E	19, 30

RECEIVED  
 BLM AT STATE OFFICE  
 2018 AUG 13 P 2:20  
 PHOENIX, ARIZONA

WC 86	AMC416432	T6N	R14E	19
WC 87	AMC416433	T6N	R14E	19, 30
WC 88	AMC416434	T6N	R14E	19
WC 89	AMC416435	T6N	R14E	19, 30
WC 90	AMC416436	T6N	R14E	19
WC 91	AMC416437	T6N	R14E	19, 30
WC 92	AMC416438	T6N	R14E	19, 30
WC 93	AMC416439	T6N	R14E	19, 30
WC 94	AMC416440	T6N	R14E	19, 30
WC 95	AMC416441	T6N	R14E	19, 20, 29, 30
WC 96	AMC416442	T6N	R13/14E	25/30
WC 97	AMC416443	T6N	R14E	25/30
WC 98	AMC416444	T6N	R14E	30
WC 99	AMC416445	T6N	R14E	30
WC 100	AMC416446	T6N	R14E	30
WC 101	AMC416447	T6N	R14E	30
WC 102	AMC416448	T6N	R14E	30
WC 103	AMC416449	T6N	R14E	30
WC 104	AMC416450	T6N	R14E	30
WC 105	AMC416451	T6N	R14E	30
WC 106	AMC416452	T6N	R14E	30
WC 107	AMC416453	T6N	R14E	30
WC 108	AMC416454	T6N	R14E	30
WC 109	AMC416455	T6N	R14E	30
WC 110	AMC416456	T6N	R14E	30
WC 111	AMC416457	T6N	R14E	30
WC 112	AMC416458	T6N	R14E	30
WC 113	AMC416459	T6N	R14E	30
WC 114	AMC416460	T6N	R14E	29, 30
WC 115	AMC416461	T6N	R14E	29, 30
WC 116	AMC416462	T6N	R14E	29
WC 117	AMC416463	T6N	R14E	29
WC 118	AMC416464	T6N	R14E	29
WC 119	AMC416465	T6N	R14E	29
WC 120	AMC416466	T6N	R14E	29
WC 121	AMC416467	T6N	R14E	29
WC 122	AMC416468	T6N	R14E	29
WC 123	AMC416469	T6N	R14E	29
WC 124	AMC416470	T6N	R14E	29
WC 125	AMC416471	T6N	R14E	30, 31
WC 126	AMC416472	T6N	R14E	31
WC 127	AMC416473	T6N	R14E	30, 31
WC 128	AMC416474	T6N	R14E	31
WC 129	AMC416475	T6N	R14E	30, 31
WC 130	AMC416476	T6N	R14E	31
WC 131	AMC416477	T6N	R14E	30, 31
WC 132	AMC416478	T6N	R14E	31

PHOENIX, ARIZONA

2008 AUG 13 P 2:20

RECEIVED  
BLM AZ STATE OFFICE

WC 133	AMC416479	T6N	R14E	30, 31
WC 134	AMC416480	T6N	R14E	31
WC 135	AMC416481	T6N	R14E	30, 31
WC 136	AMC416482	T6N	R14E	31
WC 137	AMC416483	T6N	R14E	30, 31
WC 138	AMC416484	T6N	R14E	31
WC 139	AMC416485	T6N	R14E	30, 31
WC 140	AMC416486	T6N	R14E	31
WC 141	AMC416487	T6N	R14E	29, 30, 31, 32
WC 142	AMC416488	T6N	R14E	31, 32
WC 143	AMC416489	T6N	R14E	29, 32
WC 144	AMC416490	T6N	R14E	32
WC 145	AMC416491	T6N	R14E	29, 32
WC 146	AMC416492	T6N	R14E	32
WC 147	AMC416493	T6N	R14E	29, 32
WC 148	AMC416494	T6N	R14E	32
WC 149	AMC416495	T6N	R14E	29, 32
WC 150	AMC416496	T6N	R14E	32
WC 151	AMC416497	T6N	R14E	29, 32
WC 152	AMC416498	T6N	R14E	31, 32
WC 153	AMC416499	T6N	R14E	32
WC 154	AMC416500	T6N	R14E	32
WC 155	AMC416501	T6N	R14E	32
WC 156	AMC416502	T6N	R14E	19

PHOENIX, ARIZONA

2018 AUG 13 P 2:20

RECEIVED  
BLM AZ STATE OFFICE



Uranium Energy Corp

500 N. Shoreline Blvd. Suite 800N  
Corpus Christi, Texas 78401

**CERTIFIED MAIL**



7016 0600 0000 3466 1912



1000



85004

U.S. POSTAGE  
PAID  
AUSTIN TX  
78759  
AUG 08 18  
AMOUNT

**\$7.83**

R2304E105577-20

Bureau of Land Management  
One North Central Avenue, Suite 800  
Phoenix, AZ 85004-4427

RECEIVED  
BLM AZ STATE OFFICE  
2018 AUG 13 P 2:19  
PHOENIX, ARIZONA

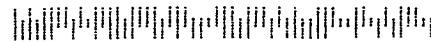

**United States Department of the Interior**  
**Bureau of Land Management**  
 DIV OF LANDS, MINRLS & ENERGY  
 ONE N CENTRAL AVE  
 PHOENIX, AZ 85004 -4427  
 Phone: 602-417-9200

Receipt

No: 4235165

<b>Transaction #:</b> 4350520	
<b>Date of Transaction:</b> 08/14/2018	
<b>CUSTOMER:</b>	
URANIUM ENERGY CORP 500 N SHORELINE BLVD STE 800N CORPUS CHRISTI, TX 78401-0399 US	

LINE #	QTY	DESCRIPTION	REMARKS	UNIT PRICE	TOTAL
1	1.00	LOCATABLE MINERALS / MINING CLAIMS- NOT NEW-UNADJUD, ONE AUTH NO. ONLY / MINING CLAIM MONEY RECEIVED <b>CASES: AMC361520/\$90520.00</b>	MAINT 2019/584	- n/a -	90520.00
<b>TOTAL:</b>					<b>\$90,520.00</b>

PAYMENT INFORMATION			
1	AMOUNT:	90520.00	POSTMARKED: N/A
	TYPE:	CHECK	RECEIVED: 08/13/2018
	CHECK NO:	20482	
	NAME:	URANIUM ENERGY CORP 500 N SHORELINE BLVD STE 800N CORPUS CHRISTI TX 78401-0399 US	

REMARKS

This receipt was generated by the automated BLM Collections and Billing System and is a paper representation of a portion of the official electronic record contained therein.



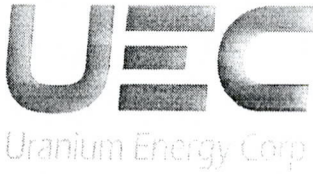

366751 393473 361520  
 403601 410884 388128  
 407697 365258  
 366483

394954  
 414006  
 416412

2017 AUG 15 P 3:00  
 PHOENIX, ARIZONA

CERTIFIED MAIL  
 7017 0190 0000 67964865

August 15, 2017

Bureau of Land Management  
 One North Central Avenue, Suite 800  
 Phoenix, AZ 85004-4427

To Whom It May Concern:

Please find attached our check for Assessment Fees fee sof \$90,520.00 for 584 mining claims, and a self-addressed stamped envelope for your use in returning a copy of your receipt notice Assessment Fees for our mining claims as defined on the attached list of claims.

Please contact our land department at (512) 450-4480 if you have any questions.

Regards,

Leonard G. Garcia  
 Manager, Land

Attachments

# 3940 413

ENTERED  
 AUG 21 2017  
 BY: RAm

# ARIZONA

Claim Name	BLM #	Township	Range	Section
AM 1	AMC361520	11N	10W	15, 16
AM 2	AMC361521	11N	10W	15
AM 3	AMC361522	11N	10W	15, 16
AM 4	AMC361523	11N	10W	15
AM 5	AMC361524	11N	10W	15, 16
AM 6	AMC361525	11N	10W	15
AM 7	AMC361526	11N	10W	15, 16
AM 8	AMC361527	11N	10W	15, 22
AM 9	AMC361528	11N	10W	15, 16
AM 10	AMC361529	11N	10W	15, 22
AM 11	AMC361530	11N	10W	15, 16, 21, 22
AM 12	AMC361531	11N	10W	22
AM 13	AMC361532	11N	10W	21, 22
AM 14	AMC361533	11N	10W	21, 22
AM 15	AMC361534	11N	10W	21, 22
AM 16	AMC361535	11N	10W	21, 22
AM 17	AMC361536	11N	10W	21
AM 18	AMC361537	11N	10W	21, 22
AM 19	AMC361538	11N	10W	21
AM 20	AMC361539	11N	10W	21, 22
AM 21	AMC361540	11N	10W	21
AM 22	AMC361541	11N	10W	21, 22
AM 23	AMC361542	11N	10W	21
AM 24	AMC361543	11N	10W	21, 22
AM 25	AMC361544	11N	10W	15, 22
AM 26	AMC361545	11N	10W	22
AM 27	AMC361546	11N	10W	22
AM 28	AMC361547	11N	10W	22
AM 29	AMC361548	11N	10W	22
AM 30	AMC361549	11N	10W	22
AM 31	AMC361550	11N	10W	22
AM 32	AMC361551	11N	10W	22
AM 33	AMC361552	11N	10W	22
AM 34	AMC361553	11N	10W	22
AM 35	AMC361554	11N	10W	22
AM 36	AMC361555	11N	10W	22
AM 37	AMC361556	11N	10W	22
AM 38	AMC361557	11N	10W	22
AM 39	AMC361558	11N	10W	22
AM 40	AMC361559	11N	10W	22, 27
AM 41	AMC361560	11N	10W	22
AM 42	AMC361561	11N	10W	22, 27
AM 43	AMC361562	11N	10W	22, 27

RECEIVED  
 BLM / SERVICE CENTER  
 2011 AUG 15 P 3:04  
 PHOENIX, ARIZONA

AM 44	AMC361563	11N	10W	27
AM 45	AMC361564	11N	10W	27
AM 46	AMC361565	11N	10W	11
AM 47	AMC361566	11N	10W	11
AM 48	AMC361567	11N	10W	11, 14
AM 49	AMC361568	11N	10W	11
AM 50	AMC361569	11N	10W	11, 14
AM 51	AMC361570	11N	10W	11, 14
AM 52	AMC361571	11N	10W	14
AM 53	AMC361572	11N	10W	11, 14
AM 54	AMC361573	11N	10W	14
AM 55	AMC361574	11N	10W	14
AM 56	AMC361575	11N	10W	14
AM 57	AMC361576	11N	10W	14
AM 58	AMC361577	11N	10W	14
AM 59	AMC361578	11N	10W	14
AM 60	AMC361579	11N	10W	14
AM 61	AMC361580	11N	10W	14
AM 62	AMC361581	11N	10W	14
AM 63	AMC361582	11N	10W	14
AM 64	AMC361583	11N	10W	14
AM 65	AMC361584	11N	10W	14
AM 66	AMC361585	11N	10W	14
AM 67	AMC361586	11N	10W	14, 15
AM 68	AMC361587	11N	10W	14, 23
AM 69	AMC361588	11N	10W	14, 15, 23
AM 70	AMC361589	11N	10W	23
AM 71	AMC361590	11N	10W	14, 15, 22, 23
AM 72	AMC361591	11N	10W	23
AM 73	AMC361592	11N	10W	22, 23
AM 74	AMC361593	11N	10W	23
AM 75	AMC361594	11N	10W	22, 23
AM 76	AMC361595	11N	10W	23
AM 77	AMC361596	11N	10W	22, 23
AM 78	AMC361597	11N	10W	23
AM 79	AMC361598	11N	10W	22, 23
AM 80	AMC361599	11N	10W	23
AM 81	AMC361600	11N	10W	22, 23
AM 82	AMC361601	11N	10W	23
AM 83	AMC361602	11N	10W	23
AM 84	AMC361603	11N	10W	23
AM 85	AMC361604	11N	10W	22, 23
AM 86	AMC361605	11N	10W	22, 23, 26, 27
AM 87	AMC361606	11N	10W	22, 27
AM 88	AMC361607	11N	10W	26, 27
AM 89	AMC361608	11N	10W	22, 27
AM 90	AMC361609	11N	10W	26, 27

PHOENIX, ARIZONA

2011 AUG 15 P 3:04

RECEIVED  
FBI PHOENIX

AM 91	AMC361610	11N	10W	27
AM 92	AMC361611	11N	10W	26, 27
AM 93	AMC361612	11N	10W	27
AM 94	AMC361613	11N	10W	26, 27
AM 95	AMC361614	11N	10W	27
AM 96	AMC361615	11N	10W	26, 27
AM 97	AMC361616	11N	10W	27
AM 98	AMC361617	11N	10W	26, 27
AM 99	AMC361618	11N	10W	27
AM 100	AMC361619	11N	10W	26, 27
AM 101	AMC361620	11N	10W	27
AM 102	AMC361621	11N	10W	26, 27
AM 103	AMC361622	11N	10W	27
AM 104	AMC361623	11N	10W	26, 27, 34
AM 105	AMC361624	11N	10W	11, 12
AM 106	AMC361625	11N	10W	12, 13
AM 107	AMC361626	11N	10W	11, 12, 13, 14
AM 108	AMC361627	11N	10W	12, 13
AM 109	AMC361628	11N	10W	13, 14
AM 110	AMC361629	11N	10W	13
AM 111	AMC361630	11N	10W	13, 14
AM 112	AMC361631	11N	10W	13
AM 113	AMC361632	11N	10W	13, 14
AM 114	AMC361633	11N	10W	13
AM 115	AMC361634	11N	10W	13, 14
AM 116	AMC361635	11N	10W	13, 14
AM 117	AMC361636	11N	10W	14
AM 118	AMC361637	11N	10W	13, 14
AM 119	AMC361638	11N	10W	14
AM 120	AMC361639	11N	10W	13, 14
AM 121	AMC361640	11N	10W	14
AM 122	AMC361641	11N	10W	13, 14
AM 123	AMC361642	11N	10W	14
AM 124	AMC361643	11N	10W	13, 14, 24
AM 125	AMC361644	11N	10W	14, 23
AM 126	AMC361645	11N	10W	13, 14, 24
AM 127	AMC361646	11N	10W	23
AM 128	AMC361647	11N	10W	23, 24
AM 129	AMC361648	11N	10W	23
AM 130	AMC361649	11N	10W	23, 24
AM 131	AMC361650	11N	10W	23
AM 132	AMC361651	11N	10W	23, 24
AM 133	AMC361652	11N	10W	23
AM 134	AMC361653	11N	10W	23
AM 135	AMC361654	11N	10W	23
AM 136	AMC361655	11N	10W	23
AM 137	AMC361656	11N	10W	23

PHOENIX, ARIZONA

2011 AUG 15 P 3:04

RECEIVED  
M.R. OFFICE

AM 138	AMC361657 <sup>7</sup>	11N	10W	23
AM 139	AMC361658	11N	10W	23
AM 140	AMC361659	11N	10W	23
AM 141	AMC361660	11N	10W	23
AM 142	AMC361661	11N	10W	23, 26
AM 143	AMC361662	11N	10W	23, 26
AM 144	AMC361663	11N	10W	23, 26
AM 145	AMC361664	11N	10W	23, 26
AM 146	AMC361665	11N	10W	26
AM 147	AMC361666	11N	10W	26
AM 148	AMC361667	11N	10W	26
AM 149	AMC361668	11N	10W	26
AM 150	AMC361669	11N	10W	26
AM 151	AMC361670	11N	10W	26
AM 152	AMC361671	11N	10W	26
AM 153	AMC361672	11N	10W	26
AM 154	AMC361673	11N	10W	26
AM 155	AMC361674	11N	10W	26
AM 156	AMC361675	11N	10W	26
AM 157	AMC361676	11N	10W	26
AM 158	AMC361677	11N	10W	26
AM 159	AMC361678	11N	10W	26
AM 160	AMC361679	11N	10W	26, 35
AM 161	AMC361680	11N	10W	26, 35
AM 162	AMC361681	11N	10W	26, 35
AM 163	AMC361682	11N	10W	12, 13
AM 164	AMC361683	11N	10W	13
AM 165	AMC361684	11N	10W	13
AM 166	AMC361685	11N	10W	13
AM 167	AMC361686	11N	10W	13
AM 168	AMC361687	11N	10W	13
AM 169	AMC361688	11N	10W	13
AM 170	AMC361689	11N	10W	13
AM 171	AMC361690	11N	10W	13
AM 172	AMC361691	11N	10W	13
AM 173	AMC361692	11N	10W	13
AM 174	AMC361693	11N	10W	13
AM 175	AMC361694	11N	10W	13
AM 176	AMC361695	11N	10W	13
AM 177	AMC361696	11N	10W	13
AM 178	AMC361697	11N	10W	13
AM 179	AMC361698	11N	10W	13
AM 180	AMC361699	11N	10W	13, 24
AM 181	AMC361700	11N	10W	13, 24
AM 182	AMC361701	11N	10W	24
AM 183	AMC361702	11N	10W	24
AM 184	AMC361703 <sup>J</sup>	11N	10W	24

RECEIVED  
 2011 AUG 15 P 3:04  
 PHOENIX, ARIZONA

AM 185	AMC361704	11N	10W	24
AM 186	AMC361705	11N	10W	24
AM 187	AMC361706	11N	10W	24
AM 188	AMC361707	11N	10W	24
AM 189	AMC361708	11N	10W	24
AM 190	AMC361709	11N	10W	24
AM 191	AMC361710	11N	10W	23, 24
AM 192	AMC361711	11N	10W	24
AM 193	AMC361712	11N	10W	23, 24
AM 194	AMC361713	11N	10W	24
AM 195	AMC361714	11N	10W	23, 24
AM 196	AMC361715	11N	10W	24
AM 197	AMC361716	11N	10W	23, 24
AM 198	AMC361717	11N	10W	24, 25
AM 199	AMC361718	11N	10W	23, 24, 25, 26
AM 200	AMC361719	11N	10W	24, 25
AM 201	AMC361720	11N	10W	25, 26
AM 202	AMC361721	11N	10W	25
AM 203	AMC361722	11N	10W	25, 26
AM 204	AMC361723	11N	10W	25
AM 205	AMC361724	11N	10W	25, 26
AM 206	AMC361725	11N	10W	25
AM 207	AMC361726	11N	10W	25, 26
AM 208	AMC361727	11N	10W	25
AM 209	AMC361728	11N	10W	25, 26
AM 210	AMC361729	11N	10W	25, 26
AM 211	AMC361730	11N	10W	25, 26
AM 212	AMC361731	11N	10W	25, 26
AM 213	AMC361732	11N	10W	25, 26
AM 214	AMC361733	11N	10W	25, 26
AM 215	AMC361734	11N	10W	25, 26
AM 216	AMC361735	11N	10W	25, 26, 36
AM 217	AMC388128	11N	10W	9, 10
AM 218	AMC388129	11N	10W	9, 10
AM 219	AMC388130	11N	10W	9, 10
AM 220	AMC388131	11N	10W	10
AM 221	AMC388132	11N	10W	10
AM 222	AMC388133	11N	10W	10
AM 223	AMC388134	11N	10W	3, 10
AM 224	AMC388135	11N	10W	10
AM 225	AMC388136	11N	10W	3
AM 226	AMC388137	11N	10W	3
AM 227	AMC388138	11N	10W	3
AM 228	AMC388139	11N	10W	3
AM 229	AMC388140	11N	10W	3
AM 230	AMC388141	11N	10W	3
AM 231	AMC388142	11N	10W	10, 11

PHOENIX, ARIZONA

2017 AUG 15 P 3:04

RECEIVED

AM 232	AMC388143	11N	10W	11
AM 233	AMC388144	11N	10W	10, 11
AM 234	AMC388145	11N	10W	11
AM 235	AMC388146	11N	10W	2, 3, 10, 11
AM 236	AMC388147	11N	10W	11
AM 237	AMC388148	11N	10W	2, 3, 11
AM 238	AMC388149	11N	10W	2, 11
AM 239	AMC388150	11N	10W	11
AM 240	AMC388151	11N	10W	11
AM 241	AMC388152	11N	10W	11
AM 242	AMC388153	11N	10W	11
AM 243	AMC388154	11N	10W	11
AM 244	AMC388155	11N	10W	11
AM 245	AMC388156	11N	10W	11
AM 246	AMC361736	11N	10W	10
AM 247	AMC361737	11N	10W	10
AM 248	AMC361738	11N	10W	10, 11
AM 249	AMC361739	11N	10W	11
AM 250	AMC361740	11N	10W	11
AM 251	AMC361741	11N	10W	11
AM 252	AMC361742	11N	10W	11
AM 253	AMC361743	11N	10W	11
AM 254	AMC361744	11N	10W	9, 15, 16
AM 255	AMC361745	11N	10W	9, 16
AM 256	AMC361746	11N	10W	9, 10, 15
AM 257	AMC361747	11N	10W	9
AM 258	AMC361748	11N	10W	9, 10
AM 259	AMC361749	11N	10W	9
AM 260	AMC361750	11N	10W	9, 10
AM 261	AMC361751	11N	10W	9
AM 262	AMC361752	11N	10W	9, 10
AM 263	AMC361753	11N	10W	9
AM 264	AMC361754	11N	10W	27, 34
AM 265	AMC365258	11N	10W	10, 11
AM 266	AMC365259	11N	10W	11
AM 267	AMC365260	11N	10W	10, 11
AM 268	AMC365261	11N	10W	10, 11
AM 269	AMC365262	11N	10W	10, 11
AM 270	AMC365263	11N	10W	10, 11
AM 271	AMC365264	11N	10W	10, 11, 15
AM 272	AMC365265	11N	10W	10, 11, 14, 15
AM 273	AMC365266	11N	10W	10, 15
AM 274	AMC365267	11N	10W	14, 15
AM 275	AMC365268	11N	10W	15
AM 276	AMC365269	11N	10W	14, 15
AM 277	AMC365270	11N	10W	15
AM 278	AMC365271	11N	10W	14, 15

PHOENIX, ARIZONA

2011 AUG 15 P 3:04

RECEIVED  
 PHOENIX, ARIZONA

AM 279	AMC365272	11N	10W	15
AM 280	AMC365273	11N	10W	14, 15
AM 281	AMC365274	11N	10W	15
AM 282	AMC365275	11N	10W	14, 15
AM 283	AMC365276	11N	10W	15
AM 284	AMC365277	11N	10W	14, 15
AM 285	AMC365278	11N	10W	15
AM 286	AMC365279	11N	10W	14, 15
AM 287	AMC365280	11N	10W	10
AM 288	AMC365281	11N	10W	10
AM 289	AMC365282	11N	10W	10
AM 290	AMC365283	11N	10W	10
AM 291	AMC365284	11N	10W	10
AM 292	AMC365285	11N	10W	10, 15
AM 293	AMC365286	11N	10W	10, 15
AM 294	AMC365287	11N	10W	10, 15
AM 295	AMC365288	11N	10W	15
AM 296	AMC365289	11N	10W	15
AM 297	AMC365290	11N	10W	15, 16
AM 298	AMC365291	11N	10W	15
AM 299	AMC365292	11N	10W	15, 16
AM 300	AMC365293	11N	10W	15
AM 301	AMC365294	11N	10W	15
AM 302	AMC366483	11N	10W	9, 10
AM 303	AMC366484	11N	10W	10
AM 304	AMC366485	11N	10W	10
AM 305	AMC366486	11N	10W	10
AM 306	AMC366487	11N	10W	10
AM 307	AMC366488	11N	10W	10
AM 308	AMC366489	11N	10W	10, 11
AM 309	AMC366490	11N	10W	11
AM 310	AMC388157	11N	10W	11, 12
AM 311	AMC388158	11N	10W	2, 11
AM 312	AMC388159	11N	10W	2, 11, 12
AM 313	AMC388160	11N	10W	1, 2, 11, 12
AM 314	AMC388161	11N	10W	12
AM 315	AMC388162	11N	10W	12
AM 316	AMC388163	11N	10W	12
AM 317	AMC388164	11N	10W	11, 12
AM 318	AMC388165	11N	10W	12
AM 319	AMC388166	11N	10W	11, 12
AM 320	AMC388167	11N	10W	12
AM 321	AMC388168	11N	10W	11, 12
AM 322	AMC388169	11N	10W	12
AM 323	AMC388170	11N	10W	11, 12
AM 324	AMC388171	11N	10W	12
AM 325	AMC388172	11N	10W	13

INGENIA, ARIZONA

2017 AUG 15 P 3:04

RECEIVED  
 PLM  
 FOR



AM 326	AMC388173	7	11N	10W	13
AM 327	AMC388174		11N	9W/10W	18/13
AM 328	AMC388175		11N	9W/10W	18, 19/13, 24
AM 329	AMC388176		11N	9W	18, 19
AM 330	AMC388177		11N	10W	13, 24
AM 331	AMC388178		11N	9W/10W	19/ 24
AM 332	AMC388179		11N	10W	24
AM 333	AMC388180		11N	9W/10W	19/ 24
AM 334	AMC388181		11N	10W	24
AM 335	AMC388182		11N	9W/10W	19/ 24
AM 336	AMC388183		11N	10W	24
AM 337	AMC388184		11N	9W/10W	19/ 24
AM 338	AMC388185		11N	10W	24
AM 339	AMC388186		11N	9W/10W	19/ 24
AM 340	AMC388187		11N	10W	24
AM 341	AMC388188		11N	9W/10W	19/ 24
AM 342	AMC388189		11N	10W	24
AM 343	AMC388190		11N	9W/10W	19/ 24
AM 344	AMC388191		11N	10W	24
AM 345	AMC388192		11N	9W/10W	19/ 24
AM 346	AMC388193		11N	10W	24, 25
AM 347	AMC388194		11N	9W/10W	19, 30/24, 25
AM 348	AMC388195		11N	10W	24, 25
AM 349	AMC388196		11N	10W	25
AM 350	AMC388197		11N	10W	25
AM 351	AMC388198		11N	10W	25
AM 352	AMC388199		11N	10W	25
AM 353	AMC388200		11N	10W	25
AM 354	AMC388201		11N	10W	25
AM 355	AMC388202		11N	10W	25
AM 356	AMC388203		11N	10W	25
AM 357	AMC388204		11N	10W	25
AM 358	AMC393473	7	11N	10W	21
AM 359	AMC393474		11N	10W	21
AM 360	AMC393475		11N	10W	21
AM 361	AMC393476		11N	10W	21
AP 9	AMC410892	7	11N	10W	9
AP 10	AMC410893		11N	10W	9
AP 11	AMC410894		11N	10W	9
AP 12	AMC410895		11N	10W	9
AP 13	AMC410896		11N	10W	9
AP 14	AMC410897		11N	10W	9
AP 15	AMC410898		11N	10W	9
AP 16	AMC410899		11N	10W	9
AP 17	AMC410900		11N	10W	9, 16
AP 18	AMC410901		11N	10W	9, 16
AP 22	AMC410905		11N	10W	9, 10

PHOENIX, ARIZONA

2017 AUG 15 P 3: 05

RECEIVED

AP 24	AMC410907	11N	10W	9, 10
AP 26	AMC410909	11N	10W	9, 10
AP 27	AMC410910	11N	10W	9
AP 28	AMC410911	11N	10W	9, 10
AP 30	AMC410913	11N	10W	10
CE 1	AMC366751	11N	10W	11
CE 2	AMC366752	11N	10W	11
CE 3	AMC366753	11N	10W	11
CE 4	AMC366754	11N	10W	11
CE 5	AMC366755	11N	10W	11
CE 6	AMC366756	11N	10W	11
CE 7	AMC366757	11N	10W	11
CE 8	AMC366758	11N	10W	10
TH 1	AMC366759	11N	10W	10
Bak 1	AMC403601	6N	14E	20
Bak 2	AMC403602	6N	14E	20
Bak 3	AMC403603	6N	14E	20
Bak 4	AMC403604	6N	14E	20
Bak 5	AMC403605	6N	14E	20
Bak 6	AMC403606	6N	14E	29
Bak 7	AMC403607	6N	14E	29
Bak 8	AMC403608	6N	14E	29
Bak 9	AMC403609	6N	14E	29
Bak 10	AMC403610	6N	14E	20
CS 1	AMC407697	6N	14E	19
CS 2	AMC407698	6N	14E	19
CS 3	AMC407699	6N	14E	19
CS 4	AMC407700	6N	14E	19, 20
CS 5	AMC407701	6N	14E	20
CS 6	AMC407702	6N	14E	20
CS 7	AMC407703	6N	14E	20
CS 8	AMC407704	6N	14E	20
CS 9	AMC407705	6N	14E	20
CS 10	AMC407706	6N	14E	20
CS 11	AMC407707	6N	14E	20
CS 12	AMC407708	6N	14E	20
CS 13	AMC407709	6N	14E	19, 20
CS 14	AMC407710	6N	14E	19
CS 15	AMC407711	6N	14E	19
CS 16	AMC407712	6N	14E	19
CS 17	AMC407713	6N	14E	19
CS 18	AMC407714	6N	14E	19
CS 19	AMC407715	6N	14E	19, 20
CS 20	AMC407716	6N	14E	20
CS 21	AMC407717	6N	14E	20
CS 22	AMC407718	6N	14E	20
CS 23	AMC407719	6N	14E	20

PHOENIX, ARIZONA

2017 AUG 15 P 3:05

RECEIVED  
ELM  
11119F

CS 24	AMC407720	6N	14E	20, 29
CS 25	AMC407721	6N	14E	20, 29
CS 26	AMC407722	6N	14E	20, 29
CS 27	AMC407723	6N	14E	18
CS 28	AMC407724	6N	14E	18
CS 29	AMC407725	6N	14E	18
CS 30	AMC407726	6N	14E	18
CS 31	AMC407727	6N	14E	19
Oak 1	AMC403611	5N	14E	28
Oak 2	AMC403612	5N	14E	28
Oak 3	AMC403613	5N	14E	28
Oak 4	AMC403614	5N	14E	27
Oak 5	AMC403615	5N	14E	27
Oak 6	AMC403616	5N	14E	27
Oak 7	AMC403617	5N	14E	27
Oak 8	AMC403618	5N	14E	27
Oak 9	AMC403619	5N	14E	28
Oak 10	AMC403620	5N	14E	28
Pen 1	AMC403621	7N	14E	2, 11
Pen 2	AMC403622	7N	14E	2, 1, 11, 12
Pen 3	AMC403623	7N	14E	1, 12
Pen 4	AMC403624	7N	14E	1, 12
Pen 5	AMC403625	7N	14E	1, 12
Pen 6	AMC403626	7N	14E	1, 12
Pen 7	AMC403627	7N	14E	1, 12
Pen 9	AMC403628	7N	14E	1, 12
Pen 10	AMC403629	7N	14E	12
Pen 11	AMC403630	7N	14E	12
Pen 12	AMC403631	7N	14E	12
Pen 13	AMC403632	7N	14E	12
Pen 14	AMC403633	7N	14E	12
Pen 15	AMC403634	7N	14E	12
Pen 16	AMC403635	7N	14E	11, 12
Pen 17	AMC403636	7N	14E	12
Pen 18	AMC403637	7N	14E	12
Pen 19	AMC403638	7N	14E	12
Pen 20	AMC403639	7N	14E	12
Pen 21	AMC403640	7N	14E	12
Pen 22	AMC403641	7N	14E	12
Pen 23	AMC403642	7N	14E	12
Pen 24	AMC403643	7N	14E	12
Pen 25	AMC403644	7N	14E	12
Pen 26	AMC403645	7N	14E	12
Pen 27	AMC403646	7N	14E	12
Pen 28	AMC403647	7N	14E	12
Pen 29	AMC403648	7N	14E	12
Pen 30	AMC403649	7N	14E	11, 12

PHOENIX, ARIZONA

2017 AUG 15 P 3:05

RECEIVED  
FBI PHOENIX OFFICE

Pen 31	AMC403650	7N	14E	11
Pen 32	AMC403651	7N	14E	11, 14
Pen 33	AMC403652	7N	14E	11, 14, 12, 13
Pen 34	AMC403653	7N	14E	12, 13
Pen 35	AMC403654	7N	14E	12, 13
Pen 36	AMC403655	7N	14E	12, 13
Pen 37	AMC403656	7N	14E	12, 13
Pen 38	AMC403657	7N	14E	12, 13
RC 10	AMC394981	6N	14E	17
RC 11	AMC394982	6N	14E	17
RC 12	AMC394983	6N	14E	17
RC 13	AMC394984	6N	14E	17
RC 14	AMC394985	6N	14E	17
RC 15	AMC394986	6N	14E	18
RC 16	AMC394987	6N	14E	18
RC 17	AMC394988	6N	14E	18
RC 18	AMC394989	6N	14E	18
RC 19	AMC394990	6N	14E	18
RC 20	AMC394991	6N	14E	18
RC 21	AMC394992	6N	14E	17
RC 22	AMC394993	6N	14E	17
RC 23	AMC394994	6N	14E	17
RC 24	AMC394995	6N	14E	17
WC 62	AMC414006	6N	14E	18, 19
WC 63	AMC414007	6N	14E	19
WC 64	AMC414008	6N	14E	19
WC 65	AMC414009	6N	14E	19, 20, 29
WC 66	AMC416412	T6N	R14E	18, 19
WC 67	AMC416413	T6N	R14E	18, 19
WC 68	AMC416414	T6N	R14E	18, 19
WC 69	AMC416415	T6N	R13E	24
WC 70	AMC416416	T6N	R13E	24
WC 71	AMC416417	T6N	R13/14E	24/19
WC 72	AMC416418	T6N	R13/14E	24/19
WC 73	AMC416419	T6N	R14E	19
WC 74	AMC416420	T6N	R14E	19
WC 75	AMC416421	T6N	R14E	19
WC 76	AMC416422	T6N	R14E	19
WC 77	AMC416423	T6N	R14E	19
WC 78	AMC416424	T6N	R14E	19
WC 79	AMC416425	T6N	R14E	19
WC 80	AMC416426	T6N	R14E	19
WC 81	AMC416427	T6N	R14E	19
WC 82	AMC416428	T6N	R14E	19
WC 83	AMC416429	T6N	R14E	19, 30
WC 84	AMC416430	T6N	R14E	19
WC 85	AMC416431	T6N	R14E	19, 30

PHOENIX, ARIZONA

2017 AUG 15 P 3:05

RECEIVED  
CITY OF PHOENIX

WC 86	AMC416432	T6N	R14E	19
WC 87	AMC416433	T6N	R14E	19, 30
WC 88	AMC416434	T6N	R14E	19
WC 89	AMC416435	T6N	R14E	19, 30
WC 90	AMC416436	T6N	R14E	19
WC 91	AMC416437	T6N	R14E	19, 30
WC 92	AMC416438	T6N	R14E	19, 30
WC 93	AMC416439	T6N	R14E	19, 30
WC 94	AMC416440	T6N	R14E	19, 30
WC 95	AMC416441	T6N	R14E	19, 20, 29, 30
WC 96	AMC416442	T6N	R13/14E	25/30
WC 97	AMC416443	T6N	R14E	25/30
WC 98	AMC416444	T6N	R14E	30
WC 99	AMC416445	T6N	R14E	30
WC 100	AMC416446	T6N	R14E	30
WC 101	AMC416447	T6N	R14E	30
WC 102	AMC416448	T6N	R14E	30
WC 103	AMC416449	T6N	R14E	30
WC 104	AMC416450	T6N	R14E	30
WC 105	AMC416451	T6N	R14E	30
WC 106	AMC416452	T6N	R14E	30
WC 107	AMC416453	T6N	R14E	30
WC 108	AMC416454	T6N	R14E	30
WC 109	AMC416455	T6N	R14E	30
WC 110	AMC416456	T6N	R14E	30
WC 111	AMC416457	T6N	R14E	30
WC 112	AMC416458	T6N	R14E	30
WC 113	AMC416459	T6N	R14E	30
WC 114	AMC416460	T6N	R14E	29, 30
WC 115	AMC416461	T6N	R14E	29, 30
WC 116	AMC416462	T6N	R14E	29
WC 117	AMC416463	T6N	R14E	29
WC 118	AMC416464	T6N	R14E	29
WC 119	AMC416465	T6N	R14E	29
WC 120	AMC416466	T6N	R14E	29
WC 121	AMC416467	T6N	R14E	29
WC 122	AMC416468	T6N	R14E	29
WC 123	AMC416469	T6N	R14E	29
WC 124	AMC416470	T6N	R14E	29
WC 125	AMC416471	T6N	R14E	30, 31
WC 126	AMC416472	T6N	R14E	31
WC 127	AMC416473	T6N	R14E	30, 31
WC 128	AMC416474	T6N	R14E	31
WC 129	AMC416475	T6N	R14E	30, 31
WC 130	AMC416476	T6N	R14E	31
WC 131	AMC416477	T6N	R14E	30, 31
WC 132	AMC416478	T6N	R14E	31

MOENK, ARIZONA

2017 AUG 15 P 3:05

RECEIVED

WC 133	AMC416479	T6N	R14E	30, 31
WC 134	AMC416480	T6N	R14E	31
WC 135	AMC416481	T6N	R14E	30, 31
WC 136	AMC416482	T6N	R14E	31
WC 137	AMC416483	T6N	R14E	30, 31
WC 138	AMC416484	T6N	R14E	31
WC 139	AMC416485	T6N	R14E	30, 31
WC 140	AMC416486	T6N	R14E	31
WC 141	AMC416487	T6N	R14E	29, 30, 31, 32
WC 142	AMC416488	T6N	R14E	31, 32
WC 143	AMC416489	T6N	R14E	29, 32
WC 144	AMC416490	T6N	R14E	32
WC 145	AMC416491	T6N	R14E	29, 32
WC 146	AMC416492	T6N	R14E	32
WC 147	AMC416493	T6N	R14E	29, 32
WC 148	AMC416494	T6N	R14E	32
WC 149	AMC416495	T6N	R14E	29, 32
WC 150	AMC416496	T6N	R14E	32
WC 151	AMC416497	T6N	R14E	29, 32
WC 152	AMC416498	T6N	R14E	31, 32
WC 153	AMC416499	T6N	R14E	32
WC 154	AMC416500	T6N	R14E	32
WC 155	AMC416501	T6N	R14E	32
WC 156	AMC416502	T6N	R14E	19

RECEIVED  
 2017 AUG 15 P 3:05  
 TULSA, OKLAHOMA

**UEC**

Uranium Energy Corp

500 North Shoreline, Ste. 600N,  
Corpus Christi, TX 78401

**CERTIFIED MAIL**

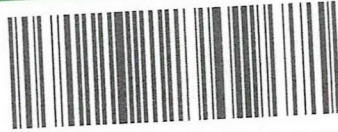

7017 0190 0000 6796 4865



RETURN RECEIPT  
REQUESTED

RECEIVED  
ELM AZ STATE OFFICE  
2011 AUG 15 P 3:04  
PHOENIX, ARIZONA

Bureau of Land Management  
0101 North Central Avenue, Suite 800  
Phoenix, AZ 85004

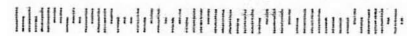

**United States Department of the Interior  
Bureau of Land Management  
DIV OF LANDS, MINRLS & ENERGY  
ONE N CENTRAL AVE  
PHOENIX, AZ 85004 -4427  
Phone: 602-417-9200**

Receipt

No: 3940413

<b>Transaction #:</b> 4050072	
<b>Date of Transaction:</b> 08/16/2017	
CUSTOMER:	
URANIUM ENERGY CORP PO BOX 2955 CORPUS CHRISTI, TX 78403-2955 US	

LINE #	QTY	DESCRIPTION	REMARKS	UNIT PRICE	TOTAL
1	1.00	LOCATABLE MINERALS / MINING CLAIMS- NOT NEW-UNADJUD, ONE AUTH NO. ONLY / MINING CLAIM MONEY RECEIVED <b>CASES: AMC361520/\$90520.00</b>	MAINT 2018/584	- n/a -	90520.00
<b>TOTAL:</b>					<b>\$90,520.00</b>

PAYMENT INFORMATION			
1	AMOUNT:	90520.00	POSTMARKED: 08/11/2017
	TYPE:	CHECK	RECEIVED: 08/15/2017
	CHECK NO:	21772	
	NAME:	URANIUM ENERGY CORP 500 N SHORELINE BLVD STE 800 N CORPUS CHRISTI TX 78401 US	

REMARKS

This receipt was generated by the automated BLM Collections and Billing System and is a paper representation of a portion of the official electronic record contained therein.





366483  
393473

410884

366751

361520  
388128  
365258

PHOENIX, ARIZONA

2016 AUG 19 P 1:41

RECEIVED  
BLM AZ STATE OFFICE

CERTIFIED MAIL

7015 1520 0003 3844 3309

August 15, 2016

Bureau of Land Management  
One North Central Avenue, Suite 800  
Phoenix, AZ 85004-4427

To Whom It May Concern:

Please find attached our Assessment Fees for our mining claims as defined on the attached list of claims. Also attached is our filing fee of \$59,830.00 for 386 mining claims, check number 19021, and a self-addressed stamped envelope for your use in returning a copy of your receipt notice.

Please contact our land department at (512) 331-6392 if you have any questions.

Regards,

Leonard G. Garcia  
Manager, Land

RECEIPT # 3636718

Attachments

ENTERED  
AUG 23 2016  
BY: RAM

RECEIVED  
BLM AZ STATE OFFICE

2016 AUG 19 PM 1:41

PHOENIX, ARIZONA

ARIZONA

Claim Name	BLM #	County Ref #	Township Range		Section
AM 1	AMC361520	4152;183	11N	10W	15, 16
AM 2	AMC361521	4152;184	11N	10W	15
AM 3	AMC361522	4152;185	11N	10W	15, 16
AM 4	AMC361523	4152;186	11N	10W	15
AM 5	AMC361524	4152;187	11N	10W	15, 16
AM 6	AMC361525	4152;188	11N	10W	15
AM 7	AMC361526	4152;189	11N	10W	15, 16
AM 8	AMC361527	4152;190	11N	10W	15, 22
AM 9	AMC361528	4152;191	11N	10W	15, 16
AM 10	AMC361529	4152;192	11N	10W	15, 22
AM 11	AMC361530	4152;193	11N	10W	15, 16, 21, 22
AM 12	AMC361531	4152;194	11N	10W	22
AM 13	AMC361532	4152;195	11N	10W	21, 22
AM 14	AMC361533	4152;196	11N	10W	21, 22
AM 15	AMC361534	4152;197	11N	10W	21, 22
AM 16	AMC361535	4152;198	11N	10W	21, 22
AM 17	AMC361536	4152;199	11N	10W	21
AM 18	AMC361537	4152;200	11N	10W	21, 22
AM 19	AMC361538	4152;201	11N	10W	21
AM 20	AMC361539	4152;202	11N	10W	21, 22
AM 21	AMC361540	4152;203	11N	10W	21
AM 22	AMC361541	4152;204	11N	10W	21, 22
AM 23	AMC361542	4152;205	11N	10W	21
AM 24	AMC361543	4152;206	11N	10W	21, 22
AM 25	AMC361544	4152;207	11N	10W	15, 22

RECEIVED  
BLM AZ STATE OFFICE

2016 AUG 19 PM 1:41  
22  
PHOENIX, ARIZONA  
22

AM 26	AMC361545	4152;208	11N	10W	
AM 27	AMC361546	4152;209	11N	10W	
AM 28	AMC361547	4152;210	11N	10W	
AM 29	AMC361548	4152;211	11N	10W	22
AM 30	AMC361549	4152;212	11N	10W	22
AM 31	AMC361550	4152;213	11N	10W	22
AM 32	AMC361551	4152;214	11N	10W	22
AM 33	AMC361552	4152;215	11N	10W	22
AM 34	AMC361553	4152;216	11N	10W	22
AM 35	AMC361554	4152;217	11N	10W	22
AM 36	AMC361555	4152;218	11N	10W	22
AM 37	AMC361556	4152;219	11N	10W	22
AM 38	AMC361557	4152;220	11N	10W	22
AM 39	AMC361558	4152;221	11N	10W	22
AM 40	AMC361559	4152;222	11N	10W	22, 27
AM 41	AMC361560	4152;223	11N	10W	22
AM 42	AMC361561	4152;224	11N	10W	22, 27
AM 43	AMC361562	4152;225	11N	10W	22, 27
AM 44	AMC361563	4152;226	11N	10W	27
AM 45	AMC361564	4152;227	11N	10W	27
AM 46	AMC361565	4152;228	11N	10W	11
AM 47	AMC361566	4152;229	11N	10W	11
AM 48	AMC361567	4152;230	11N	10W	11, 14
AM 49	AMC361568	4152;231	11N	10W	11
AM 50	AMC361569	4152;232	11N	10W	11, 14
AM 51	AMC361570	4152;233	11N	10W	11, 14
AM 52	AMC361571	4152;234	11N	10W	14
AM 53	AMC361572	4152;235	11N	10W	11, 14
AM 54	AMC361573	4152;236	11N	10W	14

RECEIVED  
BLM AZ STATE OFFICE

14  
2016 AUG 19 PM 1:41  
14  
PHOENIX, ARIZONA  
14

AM 55	AMC361574	4152;237	11N	10W	
AM 56	AMC361575	4152;238	11N	10W	
AM 57	AMC361576	4152;239	11N	10W	
AM 58	AMC361577	4152;240	11N	10W	14
AM 59	AMC361578	4152;241	11N	10W	14
AM 60	AMC361579	4152;242	11N	10W	14
AM 61	AMC361580	4152;243	11N	10W	14
AM 62	AMC361581	4152;244	11N	10W	14
AM 63	AMC361582	4152;245	11N	10W	14
AM 64	AMC361583	4152;246	11N	10W	14
AM 65	AMC361584	4152;247	11N	10W	14
AM 66	AMC361585	4152;248	11N	10W	14
AM 67	AMC361586	4152;249	11N	10W	14, 15
AM 68	AMC361587	4152;250	11N	10W	14, 23
AM 69	AMC361588	4152;251	11N	10W	14, 15, 23
AM 70	AMC361589	4152;252	11N	10W	23
AM 71	AMC361590	4152;253	11N	10W	14, 15, 22, 23
AM 72	AMC361591	4152;254	11N	10W	23
AM 73	AMC361592	4152;255	11N	10W	22, 23
AM 74	AMC361593	4152;256	11N	10W	23
AM 75	AMC361594	4152;257	11N	10W	22, 23
AM 76	AMC361595	4152;258	11N	10W	23
AM 77	AMC361596	4152;259	11N	10W	22, 23
AM 78	AMC361597	4152;260	11N	10W	23
AM 79	AMC361598	4152;261	11N	10W	22, 23
AM 80	AMC361599	4152;262	11N	10W	23
AM 81	AMC361600	4152;263	11N	10W	22, 23
AM 82	AMC361601	4152;264	11N	10W	23
AM 83	AMC361602	4152;265	11N	10W	23

RECEIVED  
BLM AZ STATE OFFICE

AM 84	AMC361603	4152;266	11N	10W	23
AM 85	AMC361604	4152;267	11N	10W	22, 23
AM 86	AMC361605	4152;268	11N	10W	27
AM 87	AMC361606	4152;269	11N	10W	22, 27
AM 88	AMC361607	4152;270	11N	10W	26, 27
AM 89	AMC361608	4152;271	11N	10W	22, 27
AM 90	AMC361609	4152;272	11N	10W	26, 27
AM 91	AMC361610	4152;273	11N	10W	27
AM 92	AMC361611	4152;274	11N	10W	26, 27
AM 93	AMC361612	4152;275	11N	10W	27
AM 94	AMC361613	4152;276	11N	10W	26, 27
AM 95	AMC361614	4152;277	11N	10W	27
AM 96	AMC361615	4152;278	11N	10W	26, 27
AM 97	AMC361616	4152;279	11N	10W	27
AM 98	AMC361617	4152;280	11N	10W	26, 27
AM 99	AMC361618	4152;281	11N	10W	27
AM 100	AMC361619	4152;282	11N	10W	26, 27
AM 101	AMC361620	4152;283	11N	10W	27
AM 102	AMC361621	4152;284	11N	10W	26, 27
AM 103	AMC361622	4152;285	11N	10W	27
AM 104	AMC361623	4152;286	11N	10W	26, 27, 34
AM 105	AMC361624	4152;287	11N	10W	11, 12
AM 106	AMC361625	4152;288	11N	10W	12, 13
AM 107	AMC361626	4152;289	11N	10W	11, 12, 13, 14
AM 108	AMC361627	4152;290	11N	10W	12, 13
AM 109	AMC361628	4152;291	11N	10W	13, 14
AM 110	AMC361629	4152;292	11N	10W	13
AM 111	AMC361630	4152;293	11N	10W	13, 14
AM 112	AMC361631	4152;294	11N	10W	13

2016 AUG 19 PM 1:41  
2102016X, ARIZONA

RECEIVED  
BLM AZ STATE OFFICE

13, 14  
2016 AUG 19 PM 1:42  
13  
PHOENIX, ARIZONA  
13, 14

AM 113	AMC361632	4152;295	11N	10W	13, 14
AM 114	AMC361633	4152;296	11N	10W	13
AM 115	AMC361634	4152;297	11N	10W	13, 14
AM 116	AMC361635	4152;298	11N	10W	13, 14
AM 117	AMC361636	4152;299	11N	10W	14
AM 118	AMC361637	4152;300	11N	10W	13, 14
AM 119	AMC361638	4152;301	11N	10W	14
AM 120	AMC361639	4152;302	11N	10W	13, 14
AM 121	AMC361640	4152;303	11N	10W	14
AM 122	AMC361641	4152;304	11N	10W	13, 14
AM 123	AMC361642	4152;305	11N	10W	14
AM 124	AMC361643	4152;306	11N	10W	13, 14, 24
AM 125	AMC361644	4152;307	11N	10W	14, 23
AM 126	AMC361645	4152;308	11N	10W	13, 14, 24
AM 127	AMC361646	4152;309	11N	10W	23
AM 128	AMC361647	4152;310	11N	10W	23, 24
AM 129	AMC361648	4152;311	11N	10W	23
AM 130	AMC361649	4152;312	11N	10W	23, 24
AM 131	AMC361650	4152;313	11N	10W	23
AM 132	AMC361651	4152;314	11N	10W	23, 24
AM 133	AMC361652	4152;315	11N	10W	23
AM 134	AMC361653	4152;316	11N	10W	23
AM 135	AMC361654	4152;317	11N	10W	23
AM 136	AMC361655	4152;318	11N	10W	23
AM 137	AMC361656	4152;319	11N	10W	23
AM 138	AMC361657	4152;320	11N	10W	23
AM 139	AMC361658	4152;321	11N	10W	23
AM 140	AMC361659	4152;322	11N	10W	23
AM 141	AMC361660	4152;323	11N	10W	23

RECEIVED  
BLM AZ STATE OFFICE  
23, 26  
2016 AUG 19 PM 1:42  
PHOENIX, ARIZONA

AM 142	AMC361661	4152;324	11N	10W	23, 26
AM 143	AMC361662	4152;325	11N	10W	23, 26
AM 144	AMC361663	4152;326	11N	10W	23, 26
AM 145	AMC361664	4152;327	11N	10W	23, 26
AM 146	AMC361665	4152;328	11N	10W	26
AM 147	AMC361666	4152;329	11N	10W	26
AM 148	AMC361667	4152;330	11N	10W	26
AM 149	AMC361668	4152;331	11N	10W	26
AM 150	AMC361669	4152;332	11N	10W	26
AM 151	AMC361670	4152;333	11N	10W	26
AM 152	AMC361671	4152;334	11N	10W	26
AM 153	AMC361672	4152;335	11N	10W	26
AM 154	AMC361673	4152;336	11N	10W	26
AM 155	AMC361674	4152;337	11N	10W	26
AM 156	AMC361675	4152;338	11N	10W	26
AM 157	AMC361676	4152;339	11N	10W	26
AM 158	AMC361677	4152;340	11N	10W	26
AM 159	AMC361678	4152;341	11N	10W	26
AM 160	AMC361679	4152;342	11N	10W	26, 35
AM 161	AMC361680	4152;343	11N	10W	26, 35
AM 162	AMC361681	4152;344	11N	10W	26, 35
AM 163	AMC361682	4152;345	11N	10W	12, 13
AM 164	AMC361683	4152;346	11N	10W	13
AM 165	AMC361684	4152;347	11N	10W	13
AM 166	AMC361685	4152;348	11N	10W	13
AM 167	AMC361686	4152;349	11N	10W	13
AM 168	AMC361687	4152;350	11N	10W	13
AM 169	AMC361688	4152;351	11N	10W	13
AM 170	AMC361689	4152;352	11N	10W	13

RECEIVED  
M.AZ STATE OFFICE

PHOENIX, ARIZONA

16 AUG 19 PM 1:42

AM 171	AMC361690	4152;353	11N	10W	13
AM 172	AMC361691	4152;354	11N	10W	13
AM 173	AMC361692	4152;355	11N	10W	13
AM 174	AMC361693	4152;356	11N	10W	13
AM 175	AMC361694	4152;357	11N	10W	13
AM 176	AMC361695	4152;358	11N	10W	13
AM 177	AMC361696	4152;359	11N	10W	13
AM 178	AMC361697	4152;360	11N	10W	13
AM 179	AMC361698	4152;361	11N	10W	13
AM 180	AMC361699	4152;362	11N	10W	13, 24
AM 181	AMC361700	4152;363	11N	10W	13, 24
AM 182	AMC361701	4152;364	11N	10W	24
AM 183	AMC361702	4152;365	11N	10W	24
AM 184	AMC361703	4152;366	11N	10W	24
AM 185	AMC361704	4152;367	11N	10W	24
AM 186	AMC361705	4152;368	11N	10W	24
AM 187	AMC361706	4152;369	11N	10W	24
AM 188	AMC361707	4152;370	11N	10W	24
AM 189	AMC361708	4152;371	11N	10W	24
AM 190	AMC361709	4152;372	11N	10W	24
AM 191	AMC361710	4152;373	11N	10W	23, 24
AM 192	AMC361711	4152;374	11N	10W	24
AM 193	AMC361712	4152;375	11N	10W	23, 24
AM 194	AMC361713	4152;376	11N	10W	24
AM 195	AMC361714	4152;377	11N	10W	23, 24
AM 196	AMC361715	4152;378	11N	10W	24
AM 197	AMC361716	4152;379	11N	10W	23, 24
AM 198	AMC361717	4152;380	11N	10W	24, 25
AM 199	AMC361718	4152;381	11N	10W	23, 24, 25, 26



AM 200	AMC361719 <sup>7</sup>	4152;382	11N	10W	24, 25
AM 201	AMC361720	4152;383	11N	10W	25, 26
AM 202	AMC361721	4152;384	11N	10W	25
AM 203	AMC361722	4152;385	11N	10W	25, 26
AM 204	AMC361723	4152;386	11N	10W	25
AM 205	AMC361724	4152;387	11N	10W	25, 26
AM 206	AMC361725	4152;388	11N	10W	25
AM 207	AMC361726	4152;389	11N	10W	25, 26
AM 208	AMC361727	4152;390	11N	10W	25
AM 209	AMC361728	4152;391	11N	10W	25, 26
AM 210	AMC361729	4152;392	11N	10W	25, 26
AM 211	AMC361730	4152;393	11N	10W	25, 26
AM 212	AMC361731	4152;394	11N	10W	25, 26
AM 213	AMC361732	4152;395	11N	10W	25, 26
AM 214	AMC361733	4152;396	11N	10W	25, 26
AM 215	AMC361734	4152;397	11N	10W	25, 26
AM 216	AMC361735 <sup>]</sup>	4152;398	11N	10W	25, 26, 36
AM 217	AMC388128 <sup>7</sup>	4553;789	11N	10W	9, 10
AM 218	AMC388129	4553;790	11N	10W	9, 10
AM 219	AMC388130	4553;791	11N	10W	9, 10
AM 220	AMC388131	4553;792	11N	10W	10
AM 221	AMC388132	4553;793	11N	10W	10
AM 222	AMC388133	4553;794	11N	10W	10
AM 223	AMC388134	4553;795	11N	10W	3, 10
AM 224	AMC388135	4553;796	11N	10W	10
AM 225	AMC388136	4553;797	11N	10W	3
AM 226	AMC388137	4553;798	11N	10W	3
AM 227	AMC388138	4553;799	11N	10W	3
AM 228	AMC388139 <sup>]</sup>	4553;800	11N	10W	3

RECEIVED  
 BLM AZ STATE OFFICE  
 PHOENIX, ARIZONA  
 2016 AUG 19 PM 1:42

AM 229	AMC388140	4553;801	11N	10W	3
AM 230	AMC388141	4553;802	11N	10W	3
AM 231	AMC388142	4553;803	11N	10W	10, 11
AM 232	AMC388143	4553;804	11N	10W	11
AM 233	AMC388144	4553;805	11N	10W	10, 11
AM 234	AMC388145	4553;806	11N	10W	11
AM 235	AMC388146	4553;807	11N	10W	2, 3, 10, 11
AM 236	AMC388147	4553;808	11N	10W	11
AM 237	AMC388148	4553;809	11N	10W	2, 3, 11
AM 238	AMC388149	4553;810	11N	10W	2, 11
AM 239	AMC388150	4553;811	11N	10W	11
AM 240	AMC388151	4553;812	11N	10W	11
AM 241	AMC388152	4553;813	11N	10W	11
AM 242	AMC388153	4553;814	11N	10W	11
AM 243	AMC388154	4553;815	11N	10W	11
AM 244	AMC388155	4553;816	11N	10W	11
AM 245	AMC388156	4553;817	11N	10W	11
AM 246	AMC361736	4152;399	11N	10W	10
AM 247	AMC361737	4152;400	11N	10W	10
AM 248	AMC361738	4152;401	11N	10W	10,11
AM 249	AMC361739	4152;402	11N	10W	11
AM 250	AMC361740	4152;403	11N	10W	11
AM 251	AMC361741	4152;404	11N	10W	11
AM 252	AMC361742	4152;405	11N	10W	11
AM 253	AMC361743	4152;406	11N	10W	11
AM 254	AMC361744	4152;407	11N	10W	9, 15, 16
AM 255	AMC361745	4152;408	11N	10W	9, 16
AM 256	AMC361746	4152;409	11N	10W	9, 10, 15
AM 257	AMC361747	4152;410	11N	10W	9

RECEIVED  
BLM AZ STATE OFFICE  
PHOENIX, ARIZONA  
2016 AUG 19 PM 1:42

AM 258	AMC361748 <sup>7</sup>	4152;411	11N	10W	9, 10
AM 259	AMC361749	4152;412	11N	10W	9
AM 260	AMC361750	4152;413	11N	10W	9, 10
AM 261	AMC361751	4152;414	11N	10W	9
AM 262	AMC361752	4152;415	11N	10W	9, 10
AM 263	AMC361753	4152;416	11N	10W	9
AM 264	AMC361754 <sub>J</sub>	4152;417	11N	10W	27, 34
AM 265	AMC365258 <sup>7</sup>	4257;894	11N	10W	10, 11
AM 266	AMC365259	4257;895	11N	10W	11
AM 267	AMC365260	4257;896	11N	10W	10, 11
AM 268	AMC365261	4257;897	11N	10W	10, 11
AM 269	AMC365262	4257;898	11N	10W	10, 11
AM 270	AMC365263	4257;899	11N	10W	10, 11
AM 271	AMC365264	4257;900	11N	10W	10, 11, 15
AM 272	AMC365265	4257;901	11N	10W	10, 11, 14, 15
AM 273	AMC365266	4257;902	11N	10W	10, 15
AM 274	AMC365267	4257;903	11N	10W	14, 15
AM 275	AMC365268	4257;904	11N	10W	15
AM 276	AMC365269	4257;905	11N	10W	14, 15
AM 277	AMC365270	4257;906	11N	10W	15
AM 278	AMC365271	4257;907	11N	10W	14, 15
AM 279	AMC365272	4257;908	11N	10W	15
AM 280	AMC365273	4257;909	11N	10W	14, 15
AM 281	AMC365274	4257;910	11N	10W	15
AM 282	AMC365275	4257;911	11N	10W	14, 15
AM 283	AMC365276	4257;912	11N	10W	15
AM 284	AMC365277	4257;913	11N	10W	14, 15
AM 285	AMC365278	4257;914	11N	10W	15
AM 286	AMC365279 <sub>J</sub>	4257;915	11N	10W	14, 15

RECEIVED  
 BLM AZ STATE OFFICE  
 2016 AUG 19 PM 1:42  
 PHOENIX, ARIZONA

AM 287	AMC365280	4257;916	11N	10W	10
AM 288	AMC365281	4257;917	11N	10W	10
AM 289	AMC365282	4257;918	11N	10W	10
AM 290	AMC365283	4257;919	11N	10W	10
AM 291	AMC365284	4257;920	11N	10W	10
AM 292	AMC365285	4257;921	11N	10W	10, 15
AM 293	AMC365286	4257;922	11N	10W	10, 15
AM 294	AMC365287	4257;923	11N	10W	10, 15
AM 295	AMC365288	4257;924	11N	10W	15
AM 296	AMC365289	4257;925	11N	10W	15
AM 297	AMC365290	4257;926	11N	10W	15, 16
AM 298	AMC365291	4257;927	11N	10W	15
AM 299	AMC365292	4257;928	11N	10W	15, 16
AM 300	AMC365293	4257;929	11N	10W	15
AM 301	AMC365294	4257;930	11N	10W	15
AM 302	AMC366483	4285;507	11N	10W	9, 10
AM 303	AMC366484	4285;508	11N	10W	10
AM 304	AMC366485	4285;509	11N	10W	10
AM 305	AMC366486	4285;510	11N	10W	10
AM 306	AMC366487	4285;511	11N	10W	10
AM 307	AMC366488	4285;512	11N	10W	10
AM 308	AMC366489	4285;513	11N	10W	10, 11
AM 309	AMC366490	4285;514	11N	10W	11
AM 310	AMC388157	4553;818	11N	10W	11, 12
AM 311	AMC388158	4553;819	11N	10W	2, 11
AM 312	AMC388159	4553;820	11N	10W	2, 11, 12
AM 313	AMC388160	4553;821	11N	10W	1, 2, 11, 12
AM 314	AMC388161	4553;822	11N	10W	12
AM 315	AMC388162	4553;823	11N	10W	12

RECEIVED  
 BLM AZ STATE OFFICE  
 2016 AUG 19 PM 1:42  
 PHOENIX, ARIZONA

AM 316	AMC388163	4553;824	11N	10W	12
AM 317	AMC388164	4553;825	11N	10W	11, 12
AM 318	AMC388165	4553;826	11N	10W	12
AM 319	AMC388166	4553;827	11N	10W	11, 12
AM 320	AMC388167	4553;828	11N	10W	12
AM 321	AMC388168	4553;829	11N	10W	11, 12
AM 322	AMC388169	4553;830	11N	10W	12
AM 323	AMC388170	4553;831	11N	10W	11, 12
AM 324	AMC388171	4553;832	11N	10W	12
AM 325	AMC388172	4553;833	11N	10W	13
AM 326	AMC388173	4553;834	11N	10W	13
AM 327	AMC388174	4553;835	11N	9W/10W	18/13
AM 328	AMC388175	4553;836	11N	9W/10W	18, 19/13, 24
AM 329	AMC388176	4553;837	11N	9W	18, 19
AM 330	AMC388177	4553;838	11N	10W	13, 24
AM 331	AMC388178	4553;839	11N	9W/10W	19/ 24
AM 332	AMC388179	4553;840	11N	10W	24
AM 333	AMC388180	4553;841	11N	9W/10W	19/ 24
AM 334	AMC388181	4553;842	11N	10W	24
AM 335	AMC388182	4553;843	11N	9W/10W	19/ 24
AM 336	AMC388183	4553;844	11N	10W	24
AM 337	AMC388184	4553;845	11N	9W/10W	19/ 24
AM 338	AMC388185	4553;846	11N	10W	24
AM 339	AMC388186	4553;847	11N	9W/10W	19/ 24
AM 340	AMC388187	4553;848	11N	10W	24
AM 341	AMC388188	4553;849	11N	9W/10W	19/ 24
AM 342	AMC388189	4553;850	11N	10W	24
AM 343	AMC388190	4553;851	11N	9W/10W	19/ 24
AM 344	AMC388191	4553;852	11N	10W	24

PHOENIX, ARIZONA

2016 AUG 19 PM 1:42

RECEIVED  
BLM AZ STATE OFFICE

AM 345	AMC388192	4553;853	11N	9W/10W	19/ 24
AM 346	AMC388193	4553;854	11N	10W	24, 25
AM 347	AMC388194	4553;855	11N	9W/10W	19, 30/24, 25
AM 348	AMC388195	4553;856	11N	10W	24, 25
AM 349	AMC388196	4553;857	11N	10W	25
AM 350	AMC388197	4553;858	11N	10W	25
AM 351	AMC388198	4553;859	11N	10W	25
AM 352	AMC388199	4553;860	11N	10W	25
AM 353	AMC388200	4553;861	11N	10W	25
AM 354	AMC388201	4553;862	11N	10W	25
AM 355	AMC388202	4553;863	11N	10W	25
AM 356	AMC388203	4553;864	11N	10W	25
AM 357	AMC388204	4553;865	11N	10W	25
AM 358	AMC393473	4602;328	11N	10W	21
AM 359	AMC393474	4602;329	11N	10W	21
AM 360	AMC393475	4602;330	11N	10W	21
AM 361	AMC393476	4602;331	11N	10W	21
AP 9	AMC410892	4833;734	11N	10W	9
AP 10	AMC410893	4833;735	11N	10W	9
AP 11	AMC410894	4833;736	11N	10W	9
AP 12	AMC410895	4833;737	11N	10W	9
AP 13	AMC410896	4833;738	11N	10W	9
AP 14	AMC410897	4833;739	11N	10W	9
AP 15	AMC410898	4833;740	11N	10W	9
AP 16	AMC410899	4833;741	11N	10W	9
AP 17	AMC410900	4833;742	11N	10W	9, 16
AP 18	AMC410901	4833;743	11N	10W	9, 16
AP 22	AMC410905	4833;747	11N	10W	9, 10
AP 24	AMC410907	4833;749	11N	10W	9, 10

PHOENIX, ARIZONA

2016 AUG 19 PM 1:42

RECEIVED  
BLM AZ STATE OFFICE

AP 26	AMC410909	4833;751	11N	10W	9, 10
AP 27	AMC410910	4833;752	11N	10W	9
AP 28	AMC410911	4833;753	11N	10W	9, 10
AP 30	AMC410913	4833;755	11N	10W	10
CE 1	AMC366751	4293;962	11N	10W	11
CE 2	AMC366752	4293;963	11N	10W	11
CE 3	AMC366753	4293;964	11N	10W	11
CE 4	AMC366754	4293;965	11N	10W	11
CE 5	AMC366755	4293;966	11N	10W	11
CE 6	AMC366756	4293;967	11N	10W	11
CE 7	AMC366757	4293;968	11N	10W	11
CE 8	AMC366758	4293;960	11N	10W	10
TH 1	AMC366759	4293;961	11N	10W	10

PHOENIX, ARIZONA

2016 AUG 19 PM 1:42

RECEIVED  
BLM AZ STATE OFFICE

**CERTIFIED MAIL**

**UEC**

Uranium Energy Corp

500 North Shoreline, Ste. 800N,  
Corpus Christi, TX 78401



7015 1520 0003 3844 3293



UNITED STATES POSTAGE  
FITNEY BOWES  
02 1R \$ 07.57<sup>0</sup>  
0002009577 AUG 16 2016  
MAILED FROM ZIP CODE 78727

RECEIVED  
BLM AZ STATE OFFICE

2016 AUG 19 P 1:34

PHOENIX, ARIZONA

Bureau of Land Management  
One North Central Ave. Suite 800  
Phoenix, AZ  
85004-4427

RETURN RECEIPT  
REQUESTED

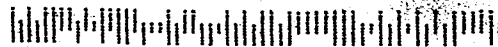

757



**United States Department of the Interior**  
**Bureau of Land Management**  
 DIV OF LANDS, MINRLS & ENERGY  
 ONE N CENTRAL AVE  
 PHOENIX, AZ 85004 -4427  
 Phone: 602-417-9200

Receipt

No: 3636718

<b>Transaction #:</b> 3740586	
<b>Date of Transaction:</b> 08/22/2016	
<b>CUSTOMER:</b>	
URANIUM ENERGY CORP PO BOX 2955 CORPUS CHRISTI, TX 78403-2955 US	

LINE #	QTY	DESCRIPTION	REMARKS	UNIT PRICE	TOTAL
1	1.00	LOCATABLE MINERALS / MINING CLAIMS- NOT NEW-UNADJUD, ONE AUTH NO. ONLY / MINING CLAIM MONEY RECEIVED CASES: AMC361520/\$59830.00	MAINT FEE 2017 - 386	- n/a -	59830.00
<b>TOTAL:</b>					<b>\$59,830.00</b>

PAYMENT INFORMATION					
1	AMOUNT:	59830.00	POSTMARKED:	08/16/2016	
	TYPE:	CHECK	RECEIVED:	08/19/2016	
	CHECK NO:	19021			
	NAME:	URANIUM ENERGY CORP 500 N SHORELINE BLVD STE 800N CORPUS CHRISTI TX 78401 US			

REMARKS

This receipt was generated by the automated BLM Collections and Billing System and is a paper representation of a portion of the official electronic record contained therein.

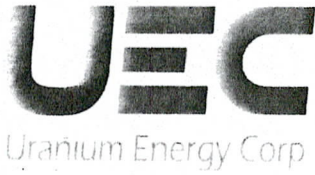

363059  
366338  
~~366751~~  
361520  
388128  
365258  
366483  
388128

August 4, 2015

CERTIFIED MAIL  
7014-0150-0002-3885-6949

393473  
410884  
403601  
394954  
403601  
407697  
414006  
416412

Bureau of Land Management  
One North Central Avenue, Suite 800  
Phoenix, AZ 85004-4427

To Whom It May Concern:

Please find attached our Assessment Fees for our mining claims as defined on the attached affidavit. Also attached is our filing fee of \$98,270.00 for 634 mining claims, check number 18212, and a self-addressed stamped envelope for your use in returning a copy of your affidavit once recorded by your office.

Please contact our land department at (361) 888-8235 if you have any questions.

Regards,

Rick Edge, Sr. Geologist

Attachments

RECEIVED  
BLM AZ REGIONAL OFFICE  
2015 AUG 10 P 3:33  
PHOENIX, ARIZONA

ENTERED  
AUG 18 2015  
RE

RECEIPT # 3364242

# ARIZONA

Claim Name	BLM #	Townshi p	Range	Section
CG 1	AMC363059	12N	13W	35
CG 2	AMC363060	12N	13W	35
CG 3	AMC363061	12N	13W	35
CG 4	AMC363062	12N	13W	35
CG 5	AMC363063	12N	13W	35
CG 6	AMC363064	12N	13W	35
CG 7	AMC363065	12N	13W	35
CG 8	AMC363066	12N	13W	35
CG 9	AMC363067	12N	13W	35
CG 10	AMC363068	12N	13W	27
CG 11	AMC363069	12N	13W	27
CG 12	AMC363070	12N	13W	27
CG 13	AMC363071	12N	13W	27
CG 14	AMC363072	12N	13W	27
CG 15	AMC363073	12N	13W	27
CG 16	AMC363074	12N	13W	27
CG 17	AMC363075	12N	13W	27
CG 18	AMC363076	12N	13W	27
CG 19	AMC363077	12N	13W	27
CG 20	AMC366338	12N	13W	36
CG 21	AMC366339	12N	13W	36
CG 22	AMC366340	12N	13W	36
CG 23	AMC366341	12N	13W	36
CG 24	AMC366342	12N	13W	36
CG 25	AMC366343	12N	13W	36
CG 26	AMC366344	12N	13W	36
CG 27	AMC366345	12N	13W	36
CG 28	AMC366346	12N	13W	36
CG 29	AMC366347	12N	13W	36
CG 30	AMC366348	12N	13W	36
CG 31	AMC366349	12N	13W	36
CG 32	AMC366350	12N	13W	36
CG 33	AMC366351	12N	13W	36
CG 34	AMC366352	12N	13W	35, 36
CG 35	AMC366353	12N	13W	36
CG 36	AMC366354	12N	13W	36
CG 37	AMC366355	12N	13W	36
CG 38	AMC366356	12N	13W	36
CG 39	AMC366357	12N	13W	36
CG 40	AMC366358	12N	13W	36
CG 41	AMC366359	12N	13W	36
CG 42	AMC366360	12N	13W	36
CG 43	AMC366361	12N	12W	31
CG 44	AMC366362	12N	12W	31
CG 45	AMC366363	12N	13W	35

RECEIVED  
BLM AZ STATE OFFICE  
2015 AUG 10 P 3:33  
PHOENIX, ARIZONA

CG 46	AMC366364	12N	13W	35
CG 47	AMC366365	12N	13W	35
CG 48	AMC366366	12N	13W	35
CG 49	AMC366367	12N	13W	35
CG 50	AMC366368	12N	13W	35
CE 1	AMC366751	11N	10W	11
CE 2	AMC366752	11N	10W	11
CE 3	AMC366753	11N	10W	11
CE 4	AMC366754	11N	10W	11
CE 5	AMC366755	11N	10W	11
CE 6	AMC366756	11N	10W	11
CE 7	AMC366757	11N	10W	11
CE 8	AMC366758	11N	10W	10
TH 1	AMC366759	11N	10W	10
AM 1	AMC361520	11N	10W	15, 16
AM 2	AMC361521	11N	10W	15
AM 3	AMC361522	11N	10W	15, 16
AM 4	AMC361523	11N	10W	15
AM 5	AMC361524	11N	10W	15, 16
AM 6	AMC361525	11N	10W	15
AM 7	AMC361526	11N	10W	15, 16
AM 8	AMC361527	11N	10W	15, 22
AM 9	AMC361528	11N	10W	15, 16
AM 10	AMC361529	11N	10W	15, 22
AM 11	AMC361530	11N	10W	15, 16, 21, 22
AM 12	AMC361531	11N	10W	22
AM 13	AMC361532	11N	10W	21, 22
AM 14	AMC361533	11N	10W	21, 22
AM 15	AMC361534	11N	10W	21, 22
AM 16	AMC361535	11N	10W	21, 22
AM 17	AMC361536	11N	10W	21
AM 18	AMC361537	11N	10W	21, 22
AM 19	AMC361538	11N	10W	21
AM 20	AMC361539	11N	10W	21, 22
AM 21	AMC361540	11N	10W	21
AM 22	AMC361541	11N	10W	21, 22
AM 23	AMC361542	11N	10W	21
AM 24	AMC361543	11N	10W	21, 22
AM 25	AMC361544	11N	10W	15, 22
AM 26	AMC361545	11N	10W	22
AM 27	AMC361546	11N	10W	22
AM 28	AMC361547	11N	10W	22
AM 29	AMC361548	11N	10W	22
AM 30	AMC361549	11N	10W	22
AM 31	AMC361550	11N	10W	22
AM 32	AMC361551	11N	10W	22
AM 33	AMC361552	11N	10W	22
AM 34	AMC361553	11N	10W	22
AM 35	AMC361554	11N	10W	22

AM 36	AMC361555	11N	10W	22
AM 37	AMC361556	11N	10W	22
AM 38	AMC361557	11N	10W	22
AM 39	AMC361558	11N	10W	22
AM 40	AMC361559	11N	10W	22, 27
AM 41	AMC361560	11N	10W	22
AM 42	AMC361561	11N	10W	22, 27
AM 43	AMC361562	11N	10W	22, 27
AM 44	AMC361563	11N	10W	27
AM 45	AMC361564	11N	10W	27
AM 46	AMC361565	11N	10W	11
AM 47	AMC361566	11N	10W	11
AM 48	AMC361567	11N	10W	11, 14
AM 49	AMC361568	11N	10W	11
AM 50	AMC361569	11N	10W	11, 14
AM 51	AMC361570	11N	10W	11, 14
AM 52	AMC361571	11N	10W	14
AM 53	AMC361572	11N	10W	11, 14
AM 54	AMC361573	11N	10W	14
AM 55	AMC361574	11N	10W	14
AM 56	AMC361575	11N	10W	14
AM 57	AMC361576	11N	10W	14
AM 58	AMC361577	11N	10W	14
AM 59	AMC361578	11N	10W	14
AM 60	AMC361579	11N	10W	14
AM 61	AMC361580	11N	10W	14
AM 62	AMC361581	11N	10W	14
AM 63	AMC361582	11N	10W	14
AM 64	AMC361583	11N	10W	14
AM 65	AMC361584	11N	10W	14
AM 66	AMC361585	11N	10W	14
AM 67	AMC361586	11N	10W	14, 15
AM 68	AMC361587	11N	10W	14, 23
AM 69	AMC361588	11N	10W	14, 15, 23
AM 70	AMC361589	11N	10W	23
AM 71	AMC361590	11N	10W	14, 15, 22, 23
AM 72	AMC361591	11N	10W	23
AM 73	AMC361592	11N	10W	22, 23
AM 74	AMC361593	11N	10W	23
AM 75	AMC361594	11N	10W	22, 23
AM 76	AMC361595	11N	10W	23
AM 77	AMC361596	11N	10W	22, 23
AM 78	AMC361597	11N	10W	23
AM 79	AMC361598	11N	10W	22, 23
AM 80	AMC361599	11N	10W	23
AM 81	AMC361600	11N	10W	22, 23
AM 82	AMC361601	11N	10W	23
AM 83	AMC361602	11N	10W	23
AM 84	AMC361603	11N	10W	23

over

RECEIVED  
BLM AIR SERVICE OFFICE  
2015 AUG 10 P 3:33  
PHOENIX, ARIZONA

AM 85	AMC361604	11N	10W	22, 23
AM 86	AMC361605	11N	10W	22, 23, 26, 27
AM 87	AMC361606	11N	10W	22, 27
AM 88	AMC361607	11N	10W	26, 27
AM 89	AMC361608	11N	10W	22, 27
AM 90	AMC361609	11N	10W	26, 27
AM 91	AMC361610	11N	10W	27
AM 92	AMC361611	11N	10W	26, 27
AM 93	AMC361612	11N	10W	27
AM 94	AMC361613	11N	10W	26, 27
AM 95	AMC361614	11N	10W	27
AM 96	AMC361615	11N	10W	26, 27
AM 97	AMC361616	11N	10W	27
AM 98	AMC361617	11N	10W	26, 27
AM 99	AMC361618	11N	10W	27
AM 100	AMC361619	11N	10W	26, 27
AM 101	AMC361620	11N	10W	27
AM 102	AMC361621	11N	10W	26, 27
AM 103	AMC361622	11N	10W	27
AM 104	AMC361623	11N	10W	26, 27, 34
AM 105	AMC361624	11N	10W	11, 12
AM 106	AMC361625	11N	10W	12, 13
AM 107	AMC361626	11N	10W	11, 12, 13, 14
AM 108	AMC361627	11N	10W	12, 13
AM 109	AMC361628	11N	10W	13, 14
AM 110	AMC361629	11N	10W	13
AM 111	AMC361630	11N	10W	13, 14
AM 112	AMC361631	11N	10W	13
AM 113	AMC361632	11N	10W	13, 14
AM 114	AMC361633	11N	10W	13
AM 115	AMC361634	11N	10W	13, 14
AM 116	AMC361635	11N	10W	13, 14
AM 117	AMC361636	11N	10W	14
AM 118	AMC361637	11N	10W	13, 14
AM 119	AMC361638	11N	10W	14
AM 120	AMC361639	11N	10W	13, 14
AM 121	AMC361640	11N	10W	14
AM 122	AMC361641	11N	10W	13, 14
AM 123	AMC361642	11N	10W	14
AM 124	AMC361643	11N	10W	13, 14, 24
AM 125	AMC361644	11N	10W	14, 23
AM 126	AMC361645	11N	10W	13, 14, 24
AM 127	AMC361646	11N	10W	23
AM 128	AMC361647	11N	10W	23, 24
AM 129	AMC361648	11N	10W	23
AM 130	AMC361649	11N	10W	23, 24
AM 131	AMC361650	11N	10W	23
AM 132	AMC361651	11N	10W	23, 24
AM 133	AMC361652	11N	10W	23

over)

RECEIVED  
BLM ANDERSON OFFICE  
2015 AUG 10 P 3:33  
PHOENIX, ARIZONA

AM 134	AMC361653	11N	10W	23
AM 135	AMC361654	11N	10W	23
AM 136	AMC361655	11N	10W	23
AM 137	AMC361656	11N	10W	23
AM 138	AMC361657	11N	10W	23
AM 139	AMC361658	11N	10W	23
AM 140	AMC361659	11N	10W	23
AM 141	AMC361660	11N	10W	23
AM 142	AMC361661	11N	10W	23, 26
AM 143	AMC361662	11N	10W	23, 26
AM 144	AMC361663	11N	10W	23, 26
AM 145	AMC361664	11N	10W	23, 26
AM 146	AMC361665	11N	10W	26
AM 147	AMC361666	11N	10W	26
AM 148	AMC361667	11N	10W	26
AM 149	AMC361668	11N	10W	26
AM 150	AMC361669	11N	10W	26
AM 151	AMC361670	11N	10W	26
AM 152	AMC361671	11N	10W	26
AM 153	AMC361672	11N	10W	26
AM 154	AMC361673	11N	10W	26
AM 155	AMC361674	11N	10W	26
AM 156	AMC361675	11N	10W	26
AM 157	AMC361676	11N	10W	26
AM 158	AMC361677	11N	10W	26
AM 159	AMC361678	11N	10W	26
AM 160	AMC361679	11N	10W	26, 35
AM 161	AMC361680	11N	10W	26, 35
AM 162	AMC361681	11N	10W	26, 35
AM 163	AMC361682	11N	10W	12, 13
AM 164	AMC361683	11N	10W	13
AM 165	AMC361684	11N	10W	13
AM 166	AMC361685	11N	10W	13
AM 167	AMC361686	11N	10W	13
AM 168	AMC361687	11N	10W	13
AM 169	AMC361688	11N	10W	13
AM 170	AMC361689	11N	10W	13
AM 171	AMC361690	11N	10W	13
AM 172	AMC361691	11N	10W	13
AM 173	AMC361692	11N	10W	13
AM 174	AMC361693	11N	10W	13
AM 175	AMC361694	11N	10W	13
AM 176	AMC361695	11N	10W	13
AM 177	AMC361696	11N	10W	13
AM 178	AMC361697	11N	10W	13
AM 179	AMC361698	11N	10W	13
AM 180	AMC361699	11N	10W	13, 24
AM 181	AMC361700	11N	10W	13, 24
AM 182	AMC361701	11N	10W	24

(over)

RECEIVED  
BLM AZ STATE OFFICE  
2015 AUG 10 P 3:33  
PHOENIX, ARIZONA

AM 183	AMC361702	11N	10W	24
AM 184	AMC361703	11N	10W	24
AM 185	AMC361704	11N	10W	24
AM 186	AMC361705	11N	10W	24
AM 187	AMC361706	11N	10W	24
AM 188	AMC361707	11N	10W	24
AM 189	AMC361708	11N	10W	24
AM 190	AMC361709	11N	10W	24
AM 191	AMC361710	11N	10W	23, 24
AM 192	AMC361711	11N	10W	24
AM 193	AMC361712	11N	10W	23, 24
AM 194	AMC361713	11N	10W	24
AM 195	AMC361714	11N	10W	23, 24
AM 196	AMC361715	11N	10W	24
AM 197	AMC361716	11N	10W	23, 24
AM 198	AMC361717	11N	10W	24, 25
AM 199	AMC361718	11N	10W	23, 24, 25, 26
AM 200	AMC361719	11N	10W	24, 25
AM 201	AMC361720	11N	10W	25, 26
AM 202	AMC361721	11N	10W	25
AM 203	AMC361722	11N	10W	25, 26
AM 204	AMC361723	11N	10W	25
AM 205	AMC361724	11N	10W	25, 26
AM 206	AMC361725	11N	10W	25
AM 207	AMC361726	11N	10W	25, 26
AM 208	AMC361727	11N	10W	25
AM 209	AMC361728	11N	10W	25, 26
AM 210	AMC361729	11N	10W	25, 26
AM 211	AMC361730	11N	10W	25, 26
AM 212	AMC361731	11N	10W	25, 26
AM 213	AMC361732	11N	10W	25, 26
AM 214	AMC361733	11N	10W	25, 26
AM 215	AMC361734	11N	10W	25, 26
AM 216	AMC361735	11N	10W	25, 26, 36
AM 217	AMC388128	11N	10W	9, 10
AM 218	AMC388129	11N	10W	9, 10
AM 219	AMC388130	11N	10W	9, 10
AM 220	AMC388131	11N	10W	10
AM 221	AMC388132	11N	10W	10
AM 222	AMC388133	11N	10W	10
AM 223	AMC388134	11N	10W	3, 10
AM 224	AMC388135	11N	10W	10
AM 225	AMC388136	11N	10W	3
AM 226	AMC388137	11N	10W	3
AM 227	AMC388138	11N	10W	3
AM 228	AMC388139	11N	10W	3
AM 229	AMC388140	11N	10W	3
AM 230	AMC388141	11N	10W	3
AM 231	AMC388142	11N	10W	10, 11

(over)

RECEIVED  
BLM AND STATE OFFICE  
2015 AUG 10 P 3:34  
PHOENIX, ARIZONA



AM 232	AMC388143	11N	10W	11
AM 233	AMC388144	11N	10W	10, 11
AM 234	AMC388145	11N	10W	11
AM 235	AMC388146	11N	10W	2, 3, 10, 11
AM 236	AMC388147	11N	10W	11
AM 237	AMC388148	11N	10W	2, 3, 11
AM 238	AMC388149	11N	10W	2, 11
AM 239	AMC388150	11N	10W	11
AM 240	AMC388151	11N	10W	11
AM 241	AMC388152	11N	10W	11
AM 242	AMC388153	11N	10W	11
AM 243	AMC388154	11N	10W	11
AM 244	AMC388155	11N	10W	11
AM 245	AMC388156	11N	10W	11
AM 246	AMC361736	11N	10W	10
AM 247	AMC361737	11N	10W	10
AM 248	AMC361738	11N	10W	10, 11
AM 249	AMC361739	11N	10W	11
AM 250	AMC361740	11N	10W	11
AM 251	AMC361741	11N	10W	11
AM 252	AMC361742	11N	10W	11
AM 253	AMC361743	11N	10W	11
AM 254	AMC361744	11N	10W	9, 15, 16
AM 255	AMC361745	11N	10W	9, 16
AM 256	AMC361746	11N	10W	9, 10, 15
AM 257	AMC361747	11N	10W	9
AM 258	AMC361748	11N	10W	9, 10
AM 259	AMC361749	11N	10W	9
AM 260	AMC361750	11N	10W	9, 10
AM 261	AMC361751	11N	10W	9
AM 262	AMC361752	11N	10W	9, 10
AM 263	AMC361753	11N	10W	9
AM 264	AMC361754	11N	10W	27, 34
AM 265	AMC365258	11N	10W	10, 11
AM 266	AMC365259	11N	10W	11
AM 267	AMC365260	11N	10W	10, 11
AM 268	AMC365261	11N	10W	10, 11
AM 269	AMC365262	11N	10W	10, 11
AM 270	AMC365263	11N	10W	10, 11
AM 271	AMC365264	11N	10W	10, 11, 15
AM 272	AMC365265	11N	10W	10, 11, 14, 15
AM 273	AMC365266	11N	10W	10, 15
AM 274	AMC365267	11N	10W	14, 15
AM 275	AMC365268	11N	10W	15
AM 276	AMC365269	11N	10W	14, 15
AM 277	AMC365270	11N	10W	15
AM 278	AMC365271	11N	10W	14, 15
AM 279	AMC365272	11N	10W	15
AM 280	AMC365273	11N	10W	14, 15

(over)

RECEIVED  
 BLM AT BUREAU OFFICE  
 2015 AUG 10 P 3:34  
 PHOENIX, ARIZONA

AM 281	AMC365274	11N	10W	15
AM 282	AMC365275	11N	10W	14, 15
AM 283	AMC365276	11N	10W	15
AM 284	AMC365277	11N	10W	14, 15
AM 285	AMC365278	11N	10W	15
AM 286	AMC365279	11N	10W	14, 15
AM 287	AMC365280	11N	10W	10
AM 288	AMC365281	11N	10W	10
AM 289	AMC365282	11N	10W	10
AM 290	AMC365283	11N	10W	10
AM 291	AMC365284	11N	10W	10
AM 292	AMC365285	11N	10W	10, 15
AM 293	AMC365286	11N	10W	10, 15
AM 294	AMC365287	11N	10W	10, 15
AM 295	AMC365288	11N	10W	15
AM 296	AMC365289	11N	10W	15
AM 297	AMC365290	11N	10W	15, 16
AM 298	AMC365291	11N	10W	15
AM 299	AMC365292	11N	10W	15, 16
AM 300	AMC365293	11N	10W	15
AM 301	AMC365294	11N	10W	15
AM 302	AMC366483	11N	10W	9, 10
AM 303	AMC366484	11N	10W	10
AM 304	AMC366485	11N	10W	10
AM 305	AMC366486	11N	10W	10
AM 306	AMC366487	11N	10W	10
AM 307	AMC366488	11N	10W	10
AM 308	AMC366489	11N	10W	10, 11
AM 309	AMC366490	11N	10W	11
AM 310	AMC388157	11N	10W	11, 12
AM 311	AMC388158	11N	10W	2, 11
AM 312	AMC388159	11N	10W	2, 11, 12
AM 313	AMC388160	11N	10W	1, 2, 11, 12
AM 314	AMC388161	11N	10W	12
AM 315	AMC388162	11N	10W	12
AM 316	AMC388163	11N	10W	12
AM 317	AMC388164	11N	10W	11, 12
AM 318	AMC388165	11N	10W	12
AM 319	AMC388166	11N	10W	11, 12
AM 320	AMC388167	11N	10W	12
AM 321	AMC388168	11N	10W	11, 12
AM 322	AMC388169	11N	10W	12
AM 323	AMC388170	11N	10W	11, 12
AM 324	AMC388171	11N	10W	12
AM 325	AMC388172	11N	10W	13
AM 326	AMC388173	11N	10W	13
AM 327	AMC388174	11N	9W/10W	18/13
AM 328	AMC388175	11N	9W/10W	18, 19/13, 24
AM 329	AMC388176	11N	9W	18, 19

(over)

PHOENIX, ARIZONA

2015 AUG 10 P 3:34

RECEIVED  
BLM ADULTERATION OFFICE

AM 330	AMC388177	11N	10W	13, 24
AM 331	AMC388178	11N	9W/10W	19/ 24
AM 332	AMC388179	11N	10W	24
AM 333	AMC388180	11N	9W/10W	19/ 24
AM 334	AMC388181	11N	10W	24
AM 335	AMC388182	11N	9W/10W	19/ 24
AM 336	AMC388183	11N	10W	24
AM 337	AMC388184	11N	9W/10W	19/ 24
AM 338	AMC388185	11N	10W	24
AM 339	AMC388186	11N	9W/10W	19/ 24
AM 340	AMC388187	11N	10W	24
AM 341	AMC388188	11N	9W/10W	19/ 24
AM 342	AMC388189	11N	10W	24
AM 343	AMC388190	11N	9W/10W	19/ 24
AM 344	AMC388191	11N	10W	24
AM 345	AMC388192	11N	9W/10W	19/ 24
AM 346	AMC388193	11N	10W	24, 25
AM 347	AMC388194	11N	9W/10W	19, 30/24, 25
AM 348	AMC388195	11N	10W	24, 25
AM 349	AMC388196	11N	10W	25
AM 350	AMC388197	11N	10W	25
AM 351	AMC388198	11N	10W	25
AM 352	AMC388199	11N	10W	25
AM 353	AMC388200	11N	10W	25
AM 354	AMC388201	11N	10W	25
AM 355	AMC388202	11N	10W	25
AM 356	AMC388203	11N	10W	25
AM 357	AMC388204	11N	10W	25
AM 358	AMC393473	11N	10W	21
AM 359	AMC393474	11N	10W	21
AM 360	AMC393475	11N	10W	21
AM 361	AMC393476	11N	10W	21
AP 9	AMC410892	11N	10W	9
AP 10	AMC410893	11N	10W	9
AP 11	AMC410894	11N	10W	9
AP 12	AMC410895	11N	10W	9
AP 13	AMC410896	11N	10W	9
AP 14	AMC410897	11N	10W	9
AP 15	AMC410898	11N	10W	9
AP 16	AMC410899	11N	10W	9
AP 17	AMC410900	11N	10W	9, 16
AP 18	AMC410901	11N	10W	9, 16
AP 22	AMC410905	11N	10W	9, 10
AP 24	AMC410907	11N	10W	9, 10
AP 26	AMC410909	11N	10W	9, 10
AP 27	AMC410910	11N	10W	9
AP 28	AMC410911	11N	10W	9, 10
AP 30	AMC410913	11N	10W	10
Oak 1	AMC403611	5N	14E	28

over

Oak 2	AMC403612	5N	14E	28
Oak 3	AMC403613	5N	14E	28
Oak 4	AMC403614	5N	14E	27
Oak 5	AMC403615	5N	14E	27
Oak 6	AMC403616	5N	14E	27
Oak 7	AMC403617	5N	14E	27
Oak 8	AMC403618	5N	14E	27
Oak 9	AMC403619	5N	14E	28
Oak 10	AMC403620	5N	14E	28
Bak 1	AMC403601	6N	14E	20
Bak 2	AMC403602	6N	14E	20
Bak 3	AMC403603	6N	14E	20
Bak 4	AMC403604	6N	14E	20
Bak 5	AMC403605	6N	14E	20
Bak 6	AMC403606	6N	14E	29
Bak 7	AMC403607	6N	14E	29
Bak 8	AMC403608	6N	14E	29
Bak 9	AMC403609	6N	14E	29
Bak 10	AMC403610	6N	14E	20
RC 10	AMC394981	6N	14E	17
RC 11	AMC394982	6N	14E	17
RC 12	AMC394983	6N	14E	17
RC 13	AMC394984	6N	14E	17
RC 14	AMC394985	6N	14E	17
RC 15	AMC394986	6N	14E	18
RC 16	AMC394987	6N	14E	18
RC 17	AMC394988	6N	14E	18
RC 18	AMC394989	6N	14E	18
RC 19	AMC394990	6N	14E	18
RC 20	AMC394991	6N	14E	18
RC 21	AMC394992	6N	14E	17
RC 22	AMC394993	6N	14E	17
RC 23	AMC394994	6N	14E	17
RC 24	AMC394995	6N	14E	17
Pen 1	AMC403621	7N	14E	2, 11
Pen 2	AMC403622	7N	14E	2, 1, 11, 12
Pen 3	AMC403623	7N	14E	1, 12
Pen 4	AMC403624	7N	14E	1, 12
Pen 5	AMC403625	7N	14E	1, 12
Pen 6	AMC403626	7N	14E	1, 12
Pen 7	AMC403627	7N	14E	1, 12
Pen 9	AMC403628	7N	14E	1, 12
Pen 10	AMC403629	7N	14E	12
Pen 11	AMC403630	7N	14E	12
Pen 12	AMC403631	7N	14E	12
Pen 13	AMC403632	7N	14E	12
Pen 14	AMC403633	7N	14E	12
Pen 15	AMC403634	7N	14E	12
Pen 16	AMC403635	7N	14E	11, 12

(over)

PHOENIX, ARIZONA

2015 AUG 10 P 3:34

RECEIVED  
BLM ARIZONA OFFICE

Pen 17	AMC403636	7N	14E	12
Pen 18	AMC403637	7N	14E	12
Pen 19	AMC403638	7N	14E	12
Pen 20	AMC403639	7N	14E	12
Pen 21	AMC403640	7N	14E	12
Pen 22	AMC403641	7N	14E	12
Pen 23	AMC403642	7N	14E	12
Pen 24	AMC403643	7N	14E	12
Pen 25	AMC403644	7N	14E	12
Pen 26	AMC403645	7N	14E	12
Pen 27	AMC403646	7N	14E	12
Pen 28	AMC403647	7N	14E	12
Pen 29	AMC403648	7N	14E	12
Pen 30	AMC403649	7N	14E	11, 12
Pen 31	AMC403650	7N	14E	11
Pen 32	AMC403651	7N	14E	11, 14
Pen 33	AMC403652	7N	14E	11, 14, 12, 13
Pen 34	AMC403653	7N	14E	12, 13
Pen 35	AMC403654	7N	14E	12, 13
Pen 36	AMC403655	7N	14E	12, 13
Pen 37	AMC403656	7N	14E	12, 13
Pen 38	AMC403657	7N	14E	12, 13
CS 1	AMC407697	6N	14E	19
CS 2	AMC407698	6N	14E	19
CS 3	AMC407699	6N	14E	19
CS 4	AMC407700	6N	14E	19, 20
CS 5	AMC407701	6N	14E	20
CS 6	AMC407702	6N	14E	20
CS 7	AMC407703	6N	14E	20
CS 8	AMC407704	6N	14E	20
CS 9	AMC407705	6N	14E	20
CS 10	AMC407706	6N	14E	20
CS 11	AMC407707	6N	14E	20
CS 12	AMC407708	6N	14E	20
CS 13	AMC407709	6N	14E	19, 20
CS 14	AMC407710	6N	14E	19
CS 15	AMC407711	6N	14E	19
CS 16	AMC407712	6N	14E	19
CS 17	AMC407713	6N	14E	19
CS 18	AMC407714	6N	14E	19
CS 19	AMC407715	6N	14E	19, 20
CS 20	AMC407716	6N	14E	20
CS 21	AMC407717	6N	14E	20
CS 22	AMC407718	6N	14E	20
CS 23	AMC407719	6N	14E	20
CS 24	AMC407720	6N	14E	20, 29
CS 25	AMC407721	6N	14E	20, 29
CS 26	AMC407722	6N	14E	20, 29
CS 27	AMC407723 (over)	6N	14E	18

RECEIVED  
 PLM AND SERVICE OFFICE  
 2015 AUG 10 P 3:34  
 PHOENIX, ARIZONA

CS 28	AMC407724	6N	14E	18
CS 29	AMC407725	6N	14E	18
CS 30	AMC407726	6N	14E	18
CS 31	AMC407727	6N	14E	19
WC 62	AMC414006	6N	14E	18, 19
WC 63	AMC414007	6N	14E	19
WC 64	AMC414008	6N	14E	19
WC 65	AMC414009	6N	14E	19, 20, 29
WC 66	AMC416412	T6N	R14E	18, 19
WC 67	AMC416413	T6N	R14E	18, 19
WC 68	AMC416414	T6N	R14E	18, 19
WC 69	AMC416415	T6N	R13E	24
WC 70	AMC416416	T6N	R13E	24
WC 71	AMC416417	T6N	R13/14E	24/19
WC 72	AMC416418	T6N	R13/14E	24/19
WC 73	AMC416419	T6N	R14E	19
WC 74	AMC416420	T6N	R14E	19
WC 75	AMC416421	T6N	R14E	19
WC 76	AMC416422	T6N	R14E	19
WC 77	AMC416423	T6N	R14E	19
WC 78	AMC416424	T6N	R14E	19
WC 79	AMC416425	T6N	R14E	19
WC 80	AMC416426	T6N	R14E	19
WC 81	AMC416427	T6N	R14E	19
WC 82	AMC416428	T6N	R14E	19
WC 83	AMC416429	T6N	R14E	19, 30
WC 84	AMC416430	T6N	R14E	19
WC 85	AMC416431	T6N	R14E	19, 30
WC 86	AMC416432	T6N	R14E	19
WC 87	AMC416433	T6N	R14E	19, 30
WC 88	AMC416434	T6N	R14E	19
WC 89	AMC416435	T6N	R14E	19, 30
WC 90	AMC416436	T6N	R14E	19
WC 91	AMC416437	T6N	R14E	19, 30
WC 92	AMC416438	T6N	R14E	19, 30
WC 93	AMC416439	T6N	R14E	19, 30
WC 94	AMC416440	T6N	R14E	19, 30
WC 95	AMC416441	T6N	R14E	19, 20, 29, 30
WC 96	AMC416442	T6N	R13/14E	25/30
WC 97	AMC416443	T6N	R14E	25/30
WC 98	AMC416444	T6N	R14E	30
WC 99	AMC416445	T6N	R14E	30
WC 100	AMC416446	T6N	R14E	30
WC 101	AMC416447	T6N	R14E	30
WC 102	AMC416448	T6N	R14E	30
WC 103	AMC416449	T6N	R14E	30
WC 104	AMC416450	T6N	R14E	30
WC 105	AMC416451	T6N	R14E	30
WC 106	AMC416452	T6N	R14E	30

(over)

RECEIVED  
BLM AZ PHOENIX OFFICE  
2015 AUG 10 P 3:34  
PHOENIX, ARIZONA

WC 107	AMC416453	T6N	R14E	30
WC 108	AMC416454	T6N	R14E	30
WC 109	AMC416455	T6N	R14E	30
WC 110	AMC416456	T6N	R14E	30
WC 111	AMC416457	T6N	R14E	30
WC 112	AMC416458	T6N	R14E	30
WC 113	AMC416459	T6N	R14E	30
WC 114	AMC416460	T6N	R14E	29, 30
WC 115	AMC416461	T6N	R14E	29, 30
WC 116	AMC416462	T6N	R14E	29
WC 117	AMC416463	T6N	R14E	29
WC 118	AMC416464	T6N	R14E	29
WC 119	AMC416465	T6N	R14E	29
WC 120	AMC416466	T6N	R14E	29
WC 121	AMC416467	T6N	R14E	29
WC 122	AMC416468	T6N	R14E	29
WC 123	AMC416469	T6N	R14E	29
WC 124	AMC416470	T6N	R14E	29
WC 125	AMC416471	T6N	R14E	30, 31
WC 126	AMC416472	T6N	R14E	31
WC 127	AMC416473	T6N	R14E	30, 31
WC 128	AMC416474	T6N	R14E	31
WC 129	AMC416475	T6N	R14E	30, 31
WC 130	AMC416476	T6N	R14E	31
WC 131	AMC416477	T6N	R14E	30, 31
WC 132	AMC416478	T6N	R14E	31
WC 133	AMC416479	T6N	R14E	30, 31
WC 134	AMC416480	T6N	R14E	31
WC 135	AMC416481	T6N	R14E	30, 31
WC 136	AMC416482	T6N	R14E	31
WC 137	AMC416483	T6N	R14E	30, 31
WC 138	AMC416484	T6N	R14E	31
WC 139	AMC416485	T6N	R14E	30, 31
WC 140	AMC416486	T6N	R14E	31
WC 141	AMC416487	T6N	R14E	29, 30, 31, 32
WC 142	AMC416488	T6N	R14E	31, 32
WC 143	AMC416489	T6N	R14E	29, 32
WC 144	AMC416490	T6N	R14E	32
WC 145	AMC416491	T6N	R14E	29, 32
WC 146	AMC416492	T6N	R14E	32
WC 147	AMC416493	T6N	R14E	29, 32
WC 148	AMC416494	T6N	R14E	32
WC 149	AMC416495	T6N	R14E	29, 32
WC 150	AMC416496	T6N	R14E	32
WC 151	AMC416497	T6N	R14E	29, 32
WC 152	AMC416498	T6N	R14E	31, 32
WC 153	AMC416499	T6N	R14E	32
WC 154	AMC416500	T6N	R14E	32
WC 155	AMC416501	T6N	R14E	32

(over)!!

RECEIVED  
BLM AUSTIN OFFICE  
2015 AUG 10 P 3:34  
PHOENIX, ARIZONA

WC 156

AMC416502

T6N

R14E

19

RECEIVED  
BLM AGENCY OFFICE

2015 AUG 10 P 3:34

PHOENIX, ARIZONA



**United States Department of the Interior**  
**Bureau of Land Management**  
 LANDS/RECREATION & PLANNING  
 ONE N CENTRAL AVE  
 PHOENIX, AZ 85004 -2203  
 Phone: 602-417-9200

Receipt

No: 3364242

<b>Transaction #:</b> 3462287	
<b>Date of Transaction:</b> 08/11/2015	
CUSTOMER:	
URANIUM ENERGY CORP PO BOX 2955 CORPUS CHRISTI, TX 78403-2955 US	

LINE #	QTY	DESCRIPTION	REMARKS	UNIT PRICE	TOTAL
1	1.00	LOCATABLE MINERALS / MINING CLAIMS-NOT NEW-UNADJUD, ONE AUTH NO. ONLY / MINING CLAIM MONEY RECEIVED CASES: AMC363059/\$98270.00	MAINT FEE PYMNT (634) 2016	- n/a -	98270.00
<b>TOTAL:</b>					<b>\$98,270.00</b>

PAYMENT INFORMATION			
1	AMOUNT:	98270.00	POSTMARKED: N/A
	TYPE:	CHECK	RECEIVED: 08/10/2015
	CHECK NO:	18212	
	NAME:	URANIUM ENERGY CORP 500 N SHORELINE BLVD STE 800N CORPUS CHRISTI TX 78401 US	

REMARKS

This receipt was generated by the automated BLM Collections and Billing System and is a paper representation of a portion of the official electronic record contained therein.



7014 0150 0002 3885 6949



Uranium Energy Corp

500 N. Shoreline Blvd. Suite 800N  
Corpus Christi, Texas 78401

RECEIVED  
BLM PHOENIX OFFICE  
2015 AUG 10 P 3:35  
PHOENIX, ARIZONA

Bureau of Land Management  
One North Central Avenue, Suite 800  
Phoenix, AZ 85004-4427

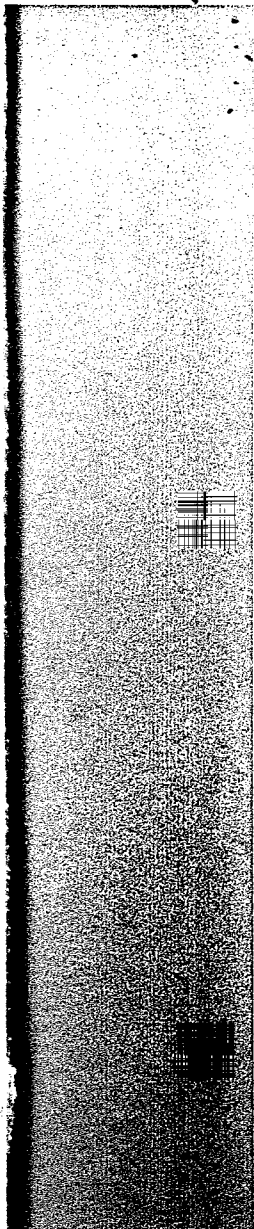

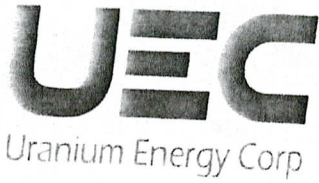

AMC363059  
 366751  
 394954 361520  
 407697 388128  
 414006 365258  
 416412  
 366483  
 393473  
 410884  
 403601

August 4, 2014

CERTIFIED MAIL  
7010 0290 0001 8991 6052

Bureau of Land Management  
One North Central Avenue, Suite 800  
Phoenix, Arizona 85004

NO. OF CLAIMS 707  
 AMOUNT \$ 109,585.00  
 RECEIPT NO. 309625  
 INIT. AA  
 \*\* BLM-ASO\*\*

To Whom It May Concern:

Please find attached our Assessment Fees for our mining claims as defined on the attached affidavit. Also attached is our filing fee of \$109,585.00 for 707 mining claims, check number 16999, and a self-addressed-stamped envelope for your use in returning a copy of our affidavit once recorded by your office.

Please contact our land department at (361) 888-8235 if you have any questions.

Regards,

*Carla West*

Attachments

RECEIVED  
 BLM AZ STATE OFFICE  
 2014 AUG - 1 P 2:24  
 PHOENIX, ARIZONA

ENTERED  
 AUG 12 2014  
 BY: RAM

UNITED STATES DEPARTMENT OF THE INTERIOR  
 BUREAU OF LAND MANAGEMENT  
 DIVISION OF SUPPORT SERVICES  
 ONE NORTH CENTRAL AVENUE, SUITE 800  
 PHOENIX, ARIZONA 85004

August 1, 2014

MAINTENANCE FEES FOR: 2015

Claim Name	BLM #	Township	Range	Section
CG 1	AMC363059	12N	13W	35
CG 2	AMC363060	12N	13W	35
CG 3	AMC363061	12N	13W	35
CG 4	AMC363062	12N	13W	35
CG 5	AMC363063	12N	13W	35
CG 6	AMC363064	12N	13W	35
CG 7	AMC363065	12N	13W	35
CG 8	AMC363066	12N	13W	35
CG 9	AMC363067	12N	13W	35
CG 10	AMC363068	12N	13W	27
CG 11	AMC363069	12N	13W	27
CG 12	AMC363070	12N	13W	27
CG 13	AMC363071	12N	13W	27
CG 14	AMC363072	12N	13W	27
CG 15	AMC363073	12N	13W	27
CG 16	AMC363074	12N	13W	27
CG 17	AMC363075	12N	13W	27
CG 18	AMC363076	12N	13W	27
CG 19	AMC363077	12N	13W	27
CG 20	AMC366338	12N	13W	36
CG 21	AMC366339	12N	13W	36
CG 22	AMC366340	12N	13W	36
CG 23	AMC366341	12N	13W	36
CG 24	AMC366342	12N	13W	36
CG 25	AMC366343	12N	13W	36
CG 26	AMC366344	12N	13W	36
CG 27	AMC366345	12N	13W	36
CG 28	AMC366346	12N	13W	36
CG 29	AMC366347	12N	13W	36
CG 30	AMC366348	12N	13W	36
CG 31	AMC366349	12N	13W	36
CG 32	AMC366350	12N	13W	36

RECEIVED  
 BLM AZ STATE OFFICE  
 2014 AUG -1 P 2:25  
 PHOENIX, ARIZONA

CG 33	AMC366351	12N	13W	36
CG 34	AMC366352	12N	13W	35, 36
CG 35	AMC366353	12N	13W	36
CG 36	AMC366354	12N	13W	36
CG 37	AMC366355	12N	13W	36
CG 38	AMC366356	12N	13W	36
CG 39	AMC366357	12N	13W	36
CG 40	AMC366358	12N	13W	36
CG 41	AMC366359	12N	13W	36
CG 42	AMC366360	12N	13W	36
CG 43	AMC366361	12N	12W	31
CG 44	AMC366362	12N	12W	31
CG 45	AMC366363	12N	13W	35
CG 46	AMC366364	12N	13W	35
CG 47	AMC366365	12N	13W	35
CG 48	AMC366366	12N	13W	35
CG 49	AMC366367	12N	13W	35
CG 50	AMC366368	12N	13W	35
CE 1	AMC366751	11N	10W	11
CE 2	AMC366752	11N	10W	11
CE 3	AMC366753	11N	10W	11
CE 4	AMC366754	11N	10W	11
CE 5	AMC366755	11N	10W	11
CE 6	AMC366756	11N	10W	11
CE 7	AMC366757	11N	10W	11
CE 8	AMC366758	11N	10W	10
TH 1	AMC366759	11N	10W	10
AM 1	AMC361520	11N	10W	15, 16
AM 2	AMC361521	11N	10W	15
AM 3	AMC361522	11N	10W	15, 16
AM 4	AMC361523	11N	10W	15
AM 5	AMC361524	11N	10W	15, 16
AM 6	AMC361525	11N	10W	15
AM 7	AMC361526	11N	10W	15, 16
AM 8	AMC361527	11N	10W	15, 22
AM 9	AMC361528	11N	10W	15, 16
AM 10	AMC361529	11N	10W	15, 22
AM 11	AMC361530	11N	10W	15, 16, 21, 22
AM 12	AMC361531	11N	10W	22
AM 13	AMC361532	11N	10W	21, 22
AM 14	AMC361533	11N	10W	21, 22
AM 15	AMC361534	11N	10W	21, 22
AM 16	AMC361535	11N	10W	21, 22
AM 17	AMC361536	11N	10W	21
AM 18	AMC361537	11N	10W	21, 22
AM 19	AMC361538	11N	10W	21

RECEIVED  
 BLM AZ STATE OFFICE  
 2014 AUG - 7 P 2:25  
 PHOENIX, ARIZONA

AM 20	AMC361539	11N	10W	21, 22
AM 21	AMC361540	11N	10W	21
AM 22	AMC361541	11N	10W	21, 22
AM 23	AMC361542	11N	10W	21
AM 24	AMC361543	11N	10W	21, 22
AM 25	AMC361544	11N	10W	15, 22
AM 26	AMC361545	11N	10W	22
AM 27	AMC361546	11N	10W	22
AM 28	AMC361547	11N	10W	22
AM 29	AMC361548	11N	10W	22
AM 30	AMC361549	11N	10W	22
AM 31	AMC361550	11N	10W	22
AM 32	AMC361551	11N	10W	22
AM 33	AMC361552	11N	10W	22
AM 34	AMC361553	11N	10W	22
AM 35	AMC361554	11N	10W	22
AM 36	AMC361555	11N	10W	22
AM 37	AMC361556	11N	10W	22
AM 38	AMC361557	11N	10W	22
AM 39	AMC361558	11N	10W	22
AM 40	AMC361559	11N	10W	22, 27
AM 41	AMC361560	11N	10W	22
AM 42	AMC361561	11N	10W	22, 27
AM 43	AMC361562	11N	10W	22, 27
AM 44	AMC361563	11N	10W	27
AM 45	AMC361564	11N	10W	27
AM 46	AMC361565	11N	10W	11
AM 47	AMC361566	11N	10W	11
AM 48	AMC361567	11N	10W	11, 14
AM 49	AMC361568	11N	10W	11
AM 50	AMC361569	11N	10W	11, 14
AM 51	AMC361570	11N	10W	11, 14
AM 52	AMC361571	11N	10W	14
AM 53	AMC361572	11N	10W	11, 14
AM 54	AMC361573	11N	10W	14
AM 55	AMC361574	11N	10W	14
AM 56	AMC361575	11N	10W	14
AM 57	AMC361576	11N	10W	14
AM 58	AMC361577	11N	10W	14
AM 59	AMC361578	11N	10W	14
AM 60	AMC361579	11N	10W	14
AM 61	AMC361580	11N	10W	14
AM 62	AMC361581	11N	10W	14
AM 63	AMC361582	11N	10W	14
AM 64	AMC361583	11N	10W	14
AM 65	AMC361584	11N	10W	14
AM 66	AMC361585	11N	10W	14

PHOENIX, ARIZONA

2014 AUG - 1 P 2:25

RECEIVED  
BLM AZ STATE OFFICE

AM 67	AMC361586	11N	10W	14, 15
AM 68	AMC361587	11N	10W	14, 23
AM 69	AMC361588	11N	10W	14, 15, 23
AM 70	AMC361589	11N	10W	23
AM 71	AMC361590	11N	10W	14, 15, 22, 23
AM 72	AMC361591	11N	10W	23
AM 73	AMC361592	11N	10W	22, 23
AM 74	AMC361593	11N	10W	23
AM 75	AMC361594	11N	10W	22, 23
AM 76	AMC361595	11N	10W	23
AM 77	AMC361596	11N	10W	22, 23
AM 78	AMC361597	11N	10W	23
AM 79	AMC361598	11N	10W	22, 23
AM 80	AMC361599	11N	10W	23
AM 81	AMC361600	11N	10W	22, 23
AM 82	AMC361601	11N	10W	23
AM 83	AMC361602	11N	10W	23
AM 84	AMC361603	11N	10W	23
AM 85	AMC361604	11N	10W	22, 23
AM 86	AMC361605	11N	10W	22, 23, 26, 27
AM 87	AMC361606	11N	10W	22, 27
AM 88	AMC361607	11N	10W	26, 27
AM 89	AMC361608	11N	10W	22, 27
AM 90	AMC361609	11N	10W	26, 27
AM 91	AMC361610	11N	10W	27
AM 92	AMC361611	11N	10W	26, 27
AM 93	AMC361612	11N	10W	27
AM 94	AMC361613	11N	10W	26, 27
AM 95	AMC361614	11N	10W	27
AM 96	AMC361615	11N	10W	26, 27
AM 97	AMC361616	11N	10W	27
AM 98	AMC361617	11N	10W	26, 27
AM 99	AMC361618	11N	10W	27
AM 100	AMC361619	11N	10W	26, 27
AM 101	AMC361620	11N	10W	27
AM 102	AMC361621	11N	10W	26, 27
AM 103	AMC361622	11N	10W	27
AM 104	AMC361623	11N	10W	26, 27, 34
AM 105	AMC361624	11N	10W	11, 12
AM 106	AMC361625	11N	10W	12, 13
AM 107	AMC361626	11N	10W	11, 12, 13, 14
AM 108	AMC361627	11N	10W	12, 13
AM 109	AMC361628	11N	10W	13, 14
AM 110	AMC361629	11N	10W	13
AM 111	AMC361630	11N	10W	13, 14

RECEIVED  
 BLM AZ STATE OFFICE  
 2014 AUG - 1 P 2:25  
 PHOENIX, ARIZONA

AM 112	AMC361631	11N	10W	13
AM 113	AMC361632	11N	10W	13, 14
AM 114	AMC361633	11N	10W	13
AM 115	AMC361634	11N	10W	13, 14
AM 116	AMC361635	11N	10W	13, 14
AM 117	AMC361636	11N	10W	14
AM 118	AMC361637	11N	10W	13, 14
AM 119	AMC361638	11N	10W	14
AM 120	AMC361639	11N	10W	13, 14
AM 121	AMC361640	11N	10W	14
AM 122	AMC361641	11N	10W	13, 14
AM 123	AMC361642	11N	10W	14
AM 124	AMC361643	11N	10W	13, 14, 24
AM 125	AMC361644	11N	10W	14, 23
AM 126	AMC361645	11N	10W	13, 14, 24
AM 127	AMC361646	11N	10W	23
AM 128	AMC361647	11N	10W	23, 24
AM 129	AMC361648	11N	10W	23
AM 130	AMC361649	11N	10W	23, 24
AM 131	AMC361650	11N	10W	23
AM 132	AMC361651	11N	10W	23, 24
AM 133	AMC361652	11N	10W	23
AM 134	AMC361653	11N	10W	23
AM 135	AMC361654	11N	10W	23
AM 136	AMC361655	11N	10W	23
AM 137	AMC361656	11N	10W	23
AM 138	AMC361657	11N	10W	23
AM 139	AMC361658	11N	10W	23
AM 140	AMC361659	11N	10W	23
AM 141	AMC361660	11N	10W	23
AM 142	AMC361661	11N	10W	23, 26
AM 143	AMC361662	11N	10W	23, 26
AM 144	AMC361663	11N	10W	23, 26
AM 145	AMC361664	11N	10W	23, 26
AM 146	AMC361665	11N	10W	26
AM 147	AMC361666	11N	10W	26
AM 148	AMC361667	11N	10W	26
AM 149	AMC361668	11N	10W	26
AM 150	AMC361669	11N	10W	26
AM 151	AMC361670	11N	10W	26
AM 152	AMC361671	11N	10W	26
AM 153	AMC361672	11N	10W	26
AM 154	AMC361673	11N	10W	26
AM 155	AMC361674	11N	10W	26
AM 156	AMC361675	11N	10W	26
AM 157	AMC361676	11N	10W	26
AM 158	AMC361677	11N	10W	26

**RECEIVED**  
 BLM AZ STATE OFFICE  
 2010 AUG - 1 P 2:25  
 PHOENIX, ARIZONA



AM 159	AMC361678	11N	10W	26
AM 160	AMC361679	11N	10W	26, 35
AM 161	AMC361680	11N	10W	26, 35
AM 162	AMC361681	11N	10W	26, 35
AM 163	AMC361682	11N	10W	12, 13
AM 164	AMC361683	11N	10W	13
AM 165	AMC361684	11N	10W	13
AM 166	AMC361685	11N	10W	13
AM 167	AMC361686	11N	10W	13
AM 168	AMC361687	11N	10W	13
AM 169	AMC361688	11N	10W	13
AM 170	AMC361689	11N	10W	13
AM 171	AMC361690	11N	10W	13
AM 172	AMC361691	11N	10W	13
AM 173	AMC361692	11N	10W	13
AM 174	AMC361693	11N	10W	13
AM 175	AMC361694	11N	10W	13
AM 176	AMC361695	11N	10W	13
AM 177	AMC361696	11N	10W	13
AM 178	AMC361697	11N	10W	13
AM 179	AMC361698	11N	10W	13
AM 180	AMC361699	11N	10W	13, 24
AM 181	AMC361700	11N	10W	13, 24
AM 182	AMC361701	11N	10W	24
AM 183	AMC361702	11N	10W	24
AM 184	AMC361703	11N	10W	24
AM 185	AMC361704	11N	10W	24
AM 186	AMC361705	11N	10W	24
AM 187	AMC361706	11N	10W	24
AM 188	AMC361707	11N	10W	24
AM 189	AMC361708	11N	10W	24
AM 190	AMC361709	11N	10W	24
AM 191	AMC361710	11N	10W	23, 24
AM 192	AMC361711	11N	10W	24
AM 193	AMC361712	11N	10W	23, 24
AM 194	AMC361713	11N	10W	24
AM 195	AMC361714	11N	10W	23, 24
AM 196	AMC361715	11N	10W	24
AM 197	AMC361716	11N	10W	23, 24
AM 198	AMC361717	11N	10W	24, 25
AM 199	AMC361718	11N	10W	23, 24, 25, 26
AM 200	AMC361719	11N	10W	24, 25
AM 201	AMC361720	11N	10W	25, 26
AM 202	AMC361721	11N	10W	25
AM 203	AMC361722	11N	10W	25, 26
AM 204	AMC361723	11N	10W	25

PHOENIX, ARIZONA

2014 AUG - 1 P 2:25

RECEIVED  
BLM AZ STATE OFFICE

AM 205	AMC361724	11N	10W	25, 26
AM 206	AMC361725	11N	10W	25
AM 207	AMC361726	11N	10W	25, 26
AM 208	AMC361727	11N	10W	25
AM 209	AMC361728	11N	10W	25, 26
AM 210	AMC361729	11N	10W	25, 26
AM 211	AMC361730	11N	10W	25, 26
AM 212	AMC361731	11N	10W	25, 26
AM 213	AMC361732	11N	10W	25, 26
AM 214	AMC361733	11N	10W	25, 26
AM 215	AMC361734	11N	10W	25, 26
AM 216	AMC361735	11N	10W	25, 26, 36
AM 217	AMC388128	11N	10W	9, 10
AM 218	AMC388129	11N	10W	9, 10
AM 219	AMC388130	11N	10W	9, 10
AM 220	AMC388131	11N	10W	10
AM 221	AMC388132	11N	10W	10
AM 222	AMC388133	11N	10W	10
AM 223	AMC388134	11N	10W	3, 10
AM 224	AMC388135	11N	10W	10
AM 225	AMC388136	11N	10W	3
AM 226	AMC388137	11N	10W	3
AM 227	AMC388138	11N	10W	3
AM 228	AMC388139	11N	10W	3
AM 229	AMC388140	11N	10W	3
AM 230	AMC388141	11N	10W	3
AM 231	AMC388142	11N	10W	10, 11
AM 232	AMC388143	11N	10W	11
AM 233	AMC388144	11N	10W	10, 11
AM 234	AMC388145	11N	10W	11
AM 235	AMC388146	11N	10W	2, 3, 10, 11
AM 236	AMC388147	11N	10W	11
AM 237	AMC388148	11N	10W	2, 3, 11
AM 238	AMC388149	11N	10W	2, 11
AM 239	AMC388150	11N	10W	11
AM 240	AMC388151	11N	10W	11
AM 241	AMC388152	11N	10W	11
AM 242	AMC388153	11N	10W	11
AM 243	AMC388154	11N	10W	11
AM 244	AMC388155	11N	10W	11
AM 245	AMC388156	11N	10W	11
AM 246	AMC361736	11N	10W	10
AM 247	AMC361737	11N	10W	10
AM 248	AMC361738	11N	10W	10, 11
AM 249	AMC361739	11N	10W	11
AM 250	AMC361740	11N	10W	11
AM 251	AMC361741	11N	10W	11

PHOENIX, ARIZONA

2014 AUG - 7 P 2:25

RECEIVED  
BLM AZ STATE OFFICE

AM 252	AMC361742	11N	10W	11
AM 253	AMC361743	11N	10W	11
AM 254	AMC361744	11N	10W	9, 15, 16
AM 255	AMC361745	11N	10W	9, 16
AM 256	AMC361746	11N	10W	9, 10, 15
AM 257	AMC361747	11N	10W	9
AM 258	AMC361748	11N	10W	9, 10
AM 259	AMC361749	11N	10W	9
AM 260	AMC361750	11N	10W	9, 10
AM 261	AMC361751	11N	10W	9
AM 262	AMC361752	11N	10W	9, 10
AM 263	AMC361753	11N	10W	9
AM 264	AMC361754	11N	10W	27, 34
AM 265	AMC365258	11N	10W	10, 11
AM 266	AMC365259	11N	10W	11
AM 267	AMC365260	11N	10W	10, 11
AM 268	AMC365261	11N	10W	10, 11
AM 269	AMC365262	11N	10W	10, 11
AM 270	AMC365263	11N	10W	10, 11
AM 271	AMC365264	11N	10W	10, 11, 15
AM 272	AMC365265	11N	10W	10, 11, 14, 15
AM 273	AMC365266	11N	10W	10, 15
AM 274	AMC365267	11N	10W	14, 15
AM 275	AMC365268	11N	10W	15
AM 276	AMC365269	11N	10W	14, 15
AM 277	AMC365270	11N	10W	15
AM 278	AMC365271	11N	10W	14, 15
AM 279	AMC365272	11N	10W	15
AM 280	AMC365273	11N	10W	14, 15
AM 281	AMC365274	11N	10W	15
AM 282	AMC365275	11N	10W	14, 15
AM 283	AMC365276	11N	10W	15
AM 284	AMC365277	11N	10W	14, 15
AM 285	AMC365278	11N	10W	15
AM 286	AMC365279	11N	10W	14, 15
AM 287	AMC365280	11N	10W	10
AM 288	AMC365281	11N	10W	10
AM 289	AMC365282	11N	10W	10
AM 290	AMC365283	11N	10W	10
AM 291	AMC365284	11N	10W	10
AM 292	AMC365285	11N	10W	10, 15
AM 293	AMC365286	11N	10W	10, 15
AM 294	AMC365287	11N	10W	10, 15
AM 295	AMC365288	11N	10W	15
AM 296	AMC365289	11N	10W	15
AM 297	AMC365290	11N	10W	15, 16

AM 298	AMC365291	11N	10W	15
AM 299	AMC365292	11N	10W	15, 16
AM 300	AMC365293	11N	10W	15
AM 301	AMC365294	11N	10W	15
AM 302	AMC366483	11N	10W	9, 10
AM 303	AMC366484	11N	10W	10
AM 304	AMC366485	11N	10W	10
AM 305	AMC366486	11N	10W	10
AM 306	AMC366487	11N	10W	10
AM 307	AMC366488	11N	10W	10
AM 308	AMC366489	11N	10W	10, 11
AM 309	AMC366490	11N	10W	11
AM 310	AMC388157	11N	10W	11, 12
AM 311	AMC388158	11N	10W	2, 11
AM 312	AMC388159	11N	10W	2, 11, 12
AM 313	AMC388160	11N	10W	1, 2, 11, 12
AM 314	AMC388161	11N	10W	12
AM 315	AMC388162	11N	10W	12
AM 316	AMC388163	11N	10W	12
AM 317	AMC388164	11N	10W	11, 12
AM 318	AMC388165	11N	10W	12
AM 319	AMC388166	11N	10W	11, 12
AM 320	AMC388167	11N	10W	12
AM 321	AMC388168	11N	10W	11, 12
AM 322	AMC388169	11N	10W	12
AM 323	AMC388170	11N	10W	11, 12
AM 324	AMC388171	11N	10W	12
AM 325	AMC388172	11N	10W	13
AM 326	AMC388173	11N	10W	13
AM 327	AMC388174	11N	9W/10W	18/13
AM 328	AMC388175	11N	9W/10W	18, 19/13, 24
AM 329	AMC388176	11N	9W	18, 19
AM 330	AMC388177	11N	10W	13, 24
AM 331	AMC388178	11N	9W/10W	19/ 24
AM 332	AMC388179	11N	10W	24
AM 333	AMC388180	11N	9W/10W	19/ 24
AM 334	AMC388181	11N	10W	24
AM 335	AMC388182	11N	9W/10W	19/ 24
AM 336	AMC388183	11N	10W	24
AM 337	AMC388184	11N	9W/10W	19/ 24
AM 338	AMC388185	11N	10W	24
AM 339	AMC388186	11N	9W/10W	19/ 24
AM 340	AMC388187	11N	10W	24
AM 341	AMC388188	11N	9W/10W	19/ 24
AM 342	AMC388189	11N	10W	24
AM 343	AMC388190	11N	9W/10W	19/ 24

RECEIVED  
 BLM AZ STATE OFFICE  
 2014 AUG - 1 P 2:25  
 PHOENIX, ARIZONA

AM 344	AMC388191	11N	10W	24
AM 345	AMC388192	11N	9W/10W	19/ 24
AM 346	AMC388193	11N	10W	24, 25
AM 347	AMC388194	11N	9W/10W	19, 30/24, 25
AM 348	AMC388195	11N	10W	24, 25
AM 349	AMC388196	11N	10W	25
AM 350	AMC388197	11N	10W	25
AM 351	AMC388198	11N	10W	25
AM 352	AMC388199	11N	10W	25
AM 353	AMC388200	11N	10W	25
AM 354	AMC388201	11N	10W	25
AM 355	AMC388202	11N	10W	25
AM 356	AMC388203	11N	10W	25
AM 357	AMC388204	11N	10W	25
AM 358	AMC393473	11N	10W	21
AM 359	AMC393474	11N	10W	21
AM 360	AMC393475	11N	10W	21
AM 361	AMC393476	11N	10W	21
AP 9	AMC410892	11N	10W	9
AP 10	AMC410893	11N	10W	9
AP 11	AMC410894	11N	10W	9
AP 12	AMC410895	11N	10W	9
AP 13	AMC410896	11N	10W	9
AP 14	AMC410897	11N	10W	9
AP 15	AMC410898	11N	10W	9
AP 16	AMC410899	11N	10W	9
AP 17	AMC410900	11N	10W	9, 16
AP 18	AMC410901	11N	10W	9, 16
AP 22	AMC410905	11N	10W	9, 10
AP 24	AMC410907	11N	10W	9, 10
AP 26	AMC410909	11N	10W	9, 10
AP 27	AMC410910	11N	10W	9
AP 28	AMC410911	11N	10W	9, 10
AP 30	AMC410913	11N	10W	10
AP 31	AMC410914	11N	10W	1, 2, 11, 12
AP 32	AMC410915	11N	10W	1
AP 33	AMC410916	11N	10W	12
AP 34	AMC410917	11N	10W	12
AP 35	AMC410918	11N	10W	12
AP 36	AMC410919	11N	10W	12
AP 37	AMC410920	11N	10W	1, 12
AP 39	AMC410922	11N	10W	12
AP 40	AMC410923	11N	9W	7, 12
AP 41	AMC410924	11N	10W	12
AP 42	AMC410925	11N	9W	7, 12
AP 43	AMC410926	11N	10W	12

RECEIVED  
 BLM AZ STATE OFFICE  
 2014 AUG - 7 P 2: 26  
 PHOENIX, ARIZONA

AP 44	AMC410927	11N	9W	7, 12
AP 45	AMC410928	11N	10W	12
AP 46	AMC410929	11N	9W	7, 12
AP 47	AMC410930	11N	10W	12
AP 48	AMC410931	11N	9W	7, 12
AP 49	AMC410932	11N	10W	12
AP 50	AMC410933	11N	9W	7, 12
AP 51	AMC410934	11N	10W	12
AP 52	AMC410935	11N	9W	7, 12
AP 53	AMC410936	11N	10W	13, 12
AP 54	AMC410937	11N	9W/10W	7, 18/13, 12
AP 55	AMC410938	11N	9W/10W	18/13
AP 56	AMC410939	11N	9W/10W	18/13
AP 57	AMC410940	11N	9W/10W	18/13
AP 58	AMC410941	11N	10W	25
AP 59	AMC410942	11N	10W	25
AP 60	AMC410943	11N	10W	25
AP 61	AMC410944	11N	10W	25
AP 62	AMC410945	11N	10W	25
AP 63	AMC410946	11N	10W	25
AP 64	AMC410947	11N	10W	25
AP 65	AMC410948	11N	10W	25
AP 66	AMC410949	11N	10W	25
AP 67	AMC410950	11N	10W	25
AP 68	AMC410951	11N	10W	25
AP 69	AMC410952	11N	10W	25
AP 70	AMC410953	11N	10W	25
AP 71	AMC410954	11N	10W	25
AP 72	AMC410955	11N	10W	25
AP 73	AMC410956	11N	10W	25
AP 74	AMC410957	11N	10W	16, 17, 20, 21
AP 75	AMC410958	11N	10W	20, 21
AP 76	AMC410959	11N	10W	20, 21
AP 77	AMC410960	11N	10W	21
AP 78	AMC410961	11N	10W	20, 21
AP 79	AMC410962	11N	10W	21
AP 80	AMC410963	11N	10W	20, 21
AP 81	AMC410964	11N	10W	21
AP 82	AMC410965	11N	10W	20, 21
AP 83	AMC410966	11N	10W	21
AP 84	AMC410967	11N	10W	20, 21
AP 85	AMC410968	11N	10W	21
AP 86	AMC410969	11N	10W	20, 21
AP 87	AMC410970	11N	10W	21
AP 88	AMC410971	11N	10W	20, 21, 28, 29

RECEIVED  
 BLM AZ STATE OFFICE  
 2011 AUG - 1 P 2:26  
 PHOENIX, ARIZONA

AP 89	AMC410972	11N	10W	21, 28
AP 90	AMC410973	11N	10W	21
AP 91	AMC410974	11N	10W	21
AP 92	AMC410975	11N	10W	21
AP 93	AMC410976	11N	10W	21, 22
AP 94	AMC410977	11N	10W	21
AP 95	AMC410978	11N	10W	21, 22
AP 96	AMC410979	11N	10W	21
AP 97	AMC410980	11N	10W	21, 22
AP 98	AMC410981	11N	10W	21
AP 99	AMC410982	11N	10W	21, 22
AP 100	AMC410983	11N	10W	21, 28
AP 101	AMC410984	11N	10W	21, 22, 27, 28
AP 102	AMC410985	11N	10W	22
AP 103	AMC410986	11N	10W	13, 18
AP 104	AMC410987	11N	10W	13, 18
Oak 1	AMC403611	5N	14E	28
Oak 2	AMC403612	5N	14E	28
Oak 3	AMC403613	5N	14E	28
Oak 4	AMC403614	5N	14E	27
Oak 5	AMC403615	5N	14E	27
Oak 6	AMC403616	5N	14E	27
Oak 7	AMC403617	5N	14E	27
Oak 8	AMC403618	5N	14E	27
Oak 9	AMC403619	5N	14E	28
Oak 10	AMC403620	5N	14E	28
Bak 1	AMC403601	6N	14E	20
Bak 2	AMC403602	6N	14E	20
Bak 3	AMC403603	6N	14E	20
Bak 4	AMC403604	6N	14E	20
Bak 5	AMC403605	6N	14E	20
Bak 6	AMC403606	6N	14E	29
Bak 7	AMC403607	6N	14E	29
Bak 8	AMC403608	6N	14E	29
Bak 9	AMC403609	6N	14E	29
Bak 10	AMC403610	6N	14E	20
RC 10	AMC394981	6N	14E	17
RC 11	AMC394982	6N	14E	17
RC 12	AMC394983	6N	14E	17
RC 13	AMC394984	6N	14E	17
RC 14	AMC394985	6N	14E	17
RC 15	AMC394986	6N	14E	18
RC 16	AMC394987	6N	14E	18
RC 17	AMC394988	6N	14E	18
RC 18	AMC394989	6N	14E	18
RC 19	AMC394990	6N	14E	18

RECEIVED  
 BLM AZ STATE OFFICE  
 2014 AUG - 1 P 2:26  
 PHOENIX, ARIZONA

RC 20	AMC394991	6N	14E	18
RC 21	AMC394992	6N	14E	17
RC 22	AMC394993	6N	14E	17
RC 23	AMC394994	6N	14E	17
RC 24	AMC394995	6N	14E	17
Pen 1	AMC403621	7N	14E	2, 11
Pen 2	AMC403622	7N	14E	2, 1, 11, 12
Pen 3	AMC403623	7N	14E	1, 12
Pen 4	AMC403624	7N	14E	1, 12
Pen 5	AMC403625	7N	14E	1, 12
Pen 6	AMC403626	7N	14E	1, 12
Pen 7	AMC403627	7N	14E	1, 12
Pen 9	AMC403628	7N	14E	1, 12
Pen 10	AMC403629	7N	14E	12
Pen 11	AMC403630	7N	14E	12
Pen 12	AMC403631	7N	14E	12
Pen 13	AMC403632	7N	14E	12
Pen 14	AMC403633	7N	14E	12
Pen 15	AMC403634	7N	14E	12
Pen 16	AMC403635	7N	14E	11, 12
Pen 17	AMC403636	7N	14E	12
Pen 18	AMC403637	7N	14E	12
Pen 19	AMC403638	7N	14E	12
Pen 20	AMC403639	7N	14E	12
Pen 21	AMC403640	7N	14E	12
Pen 22	AMC403641	7N	14E	12
Pen 23	AMC403642	7N	14E	12
Pen 24	AMC403643	7N	14E	12
Pen 25	AMC403644	7N	14E	12
Pen 26	AMC403645	7N	14E	12
Pen 27	AMC403646	7N	14E	12
Pen 28	AMC403647	7N	14E	12
Pen 29	AMC403648	7N	14E	12
Pen 30	AMC403649	7N	14E	11, 12
Pen 31	AMC403650	7N	14E	11
Pen 32	AMC403651	7N	14E	11, 14
Pen 33	AMC403652	7N	14E	11, 14, 12, 13
Pen 34	AMC403653	7N	14E	12, 13
Pen 35	AMC403654	7N	14E	12, 13
Pen 36	AMC403655	7N	14E	12, 13
Pen 37	AMC403656	7N	14E	12, 13
Pen 38	AMC403657	7N	14E	12, 13
CS 1	AMC407697	6N	14E	19
CS 2	AMC407698	6N	14E	19
CS 3	AMC407699	6N	14E	19
CS 4	AMC407700	6N	14E	19, 20

PHOENIX, ARIZONA

2014 AUG - 7 P 2: 26

RECEIVED  
BLM AZ STATE OFFICE



CS 5	AMC407701	6N	14E	20
CS 6	AMC407702	6N	14E	20
CS 7	AMC407703	6N	14E	20
CS 8	AMC407704	6N	14E	20
CS 9	AMC407705	6N	14E	20
CS 10	AMC407706	6N	14E	20
CS 11	AMC407707	6N	14E	20
CS 12	AMC407708	6N	14E	20
CS 13	AMC407709	6N	14E	19, 20
CS 14	AMC407710	6N	14E	19
CS 15	AMC407711	6N	14E	19
CS 16	AMC407712	6N	14E	19
CS 17	AMC407713	6N	14E	19
CS 18	AMC407714	6N	14E	19
CS 19	AMC407715	6N	14E	19, 20
CS 20	AMC407716	6N	14E	20
CS 21	AMC407717	6N	14E	20
CS 22	AMC407718	6N	14E	20
CS 23	AMC407719	6N	14E	20
CS 24	AMC407720	6N	14E	20, 29
CS 25	AMC407721	6N	14E	20, 29
CS 26	AMC407722	6N	14E	20, 29
CS 27	AMC407723	6N	14E	18
CS 28	AMC407724	6N	14E	18
CS 29	AMC407725	6N	14E	18
CS 30	AMC407726	6N	14E	18
CS 31	AMC407727	6N	14E	19
WC 62	AMC414006	6N	14E	18, 19
WC 63	AMC414007	6N	14E	19
WC 64	AMC414008	6N	14E	19
WC 65	AMC414009	6N	14E	19, 20, 29
WC 66	AMC416412	T6N	R14E	18, 19
WC 67	AMC416413	T6N	R14E	18, 19
WC 68	AMC416414	T6N	R14E	18, 19
WC 69	AMC416415	T6N	R13E	24
WC 70	AMC416416	T6N	R13E	24
WC 71	AMC416417	T6N	R13/14E	24/19
WC 72	AMC416418	T6N	R13/14E	24/19
WC 73	AMC416419	T6N	R14E	19
WC 74	AMC416420	T6N	R14E	19
WC 75	AMC416421	T6N	R14E	19
WC 76	AMC416422	T6N	R14E	19
WC 77	AMC416423	T6N	R14E	19
WC 78	AMC416424	T6N	R14E	19
WC 79	AMC416425	T6N	R14E	19
WC 80	AMC416426	T6N	R14E	19
WC 81	AMC416427	T6N	R14E	19

PHOENIX, ARIZONA

2011 AUG - 1 P 2: 26

RECEIVED  
BLM AZ STATE OFFICE

WC 82	AMC416428	T6N	R14E	19
WC 83	AMC416429	T6N	R14E	19, 30
WC 84	AMC416430	T6N	R14E	19
WC 85	AMC416431	T6N	R14E	19, 30
WC 86	AMC416432	T6N	R14E	19
WC 87	AMC416433	T6N	R14E	19, 30
WC 88	AMC416434	T6N	R14E	19
WC 89	AMC416435	T6N	R14E	19, 30
WC 90	AMC416436	T6N	R14E	19
WC 91	AMC416437	T6N	R14E	19, 30
WC 92	AMC416438	T6N	R14E	19, 30
WC 93	AMC416439	T6N	R14E	19, 30
WC 94	AMC416440	T6N	R14E	19, 30
WC 95	AMC416441	T6N	R14E	19, 20, 29, 30
WC 96	AMC416442	T6N	R13/14E	25/30
WC 97	AMC416443	T6N	R14E	25/30
WC 98	AMC416444	T6N	R14E	30
WC 99	AMC416445	T6N	R14E	30
WC 100	AMC416446	T6N	R14E	30
WC 101	AMC416447	T6N	R14E	30
WC 102	AMC416448	T6N	R14E	30
WC 103	AMC416449	T6N	R14E	30
WC 104	AMC416450	T6N	R14E	30
WC 105	AMC416451	T6N	R14E	30
WC 106	AMC416452	T6N	R14E	30
WC 107	AMC416453	T6N	R14E	30
WC 108	AMC416454	T6N	R14E	30
WC 109	AMC416455	T6N	R14E	30
WC 110	AMC416456	T6N	R14E	30
WC 111	AMC416457	T6N	R14E	30
WC 112	AMC416458	T6N	R14E	30
WC 113	AMC416459	T6N	R14E	30
WC 114	AMC416460	T6N	R14E	29, 30
WC 115	AMC416461	T6N	R14E	29, 30
WC 116	AMC416462	T6N	R14E	29
WC 117	AMC416463	T6N	R14E	29
WC 118	AMC416464	T6N	R14E	29
WC 119	AMC416465	T6N	R14E	29
WC 120	AMC416466	T6N	R14E	29
WC 121	AMC416467	T6N	R14E	29
WC 122	AMC416468	T6N	R14E	29
WC 123	AMC416469	T6N	R14E	29
WC 124	AMC416470	T6N	R14E	29
WC 125	AMC416471	T6N	R14E	30, 31
WC 126	AMC416472	T6N	R14E	31
WC 127	AMC416473	T6N	R14E	30, 31

PHOENIX, ARIZONA

2014 AUG - 7 P 2:26

RECEIVED  
BLM AZ STATE OFFICE

WC 128	AMC416474	T6N	R14E	31
WC 129	AMC416475	T6N	R14E	30, 31
WC 130	AMC416476	T6N	R14E	31
WC 131	AMC416477	T6N	R14E	30, 31
WC 132	AMC416478	T6N	R14E	31
WC 133	AMC416479	T6N	R14E	30, 31
WC 134	AMC416480	T6N	R14E	31
WC 135	AMC416481	T6N	R14E	30, 31
WC 136	AMC416482	T6N	R14E	31
WC 137	AMC416483	T6N	R14E	30, 31
WC 138	AMC416484	T6N	R14E	31
WC 139	AMC416485	T6N	R14E	30, 31
WC 140	AMC416486	T6N	R14E	31
WC 141	AMC416487	T6N	R14E	29, 30, 31, 32
WC 142	AMC416488	T6N	R14E	31, 32
WC 143	AMC416489	T6N	R14E	29, 32
WC 144	AMC416490	T6N	R14E	32
WC 145	AMC416491	T6N	R14E	29, 32
WC 146	AMC416492	T6N	R14E	32
WC 147	AMC416493	T6N	R14E	29, 32
WC 148	AMC416494	T6N	R14E	32
WC 149	AMC416495	T6N	R14E	29, 32
WC 150	AMC416496	T6N	R14E	32
WC 151	AMC416497	T6N	R14E	29, 32
WC 152	AMC416498	T6N	R14E	31, 32
WC 153	AMC416499	T6N	R14E	32
WC 154	AMC416500	T6N	R14E	32
WC 155	AMC416501	T6N	R14E	32
WC 156	AMC416502	T6N	R14E	19

PHOENIX, ARIZONA

2011 AUG - 1 P 2:26

RECEIVED  
BLM AZ STATE OFFICE

Number of Claims: 707 x \$155.00/claim = \$109,585.00 as maintenance fees for year 2015.

Name and address of Owner or Claimant

Uranium Energy Corp.  
ATTN: Land Dept  
PO Box 2955  
Corpus Christi, TX 78403  
(361) 888-8235

United States Department of the Interior  
 Bureau of Land Management  
 LANDS/RECREATION & PLANNING  
 ONE N CENTRAL AVE  
 PHOENIX, AZ 85004 -2203  
 Phone: 602-417-9200

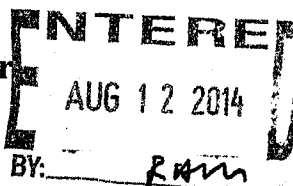

Receipt

No:

3096257

<b>Transaction #:</b> 3187741	
<b>Date of Transaction:</b> 08/08/2014	
<b>CUSTOMER:</b>	
URANIUM ENERGY CORP PO BOX 2955 CORPUS CHRISTI, TX 78403-2955 US	

LINE #	QTY	DESCRIPTION	REMARKS	UNIT PRICE	TOTAL
1	1.00	LOCATABLE MINERALS / MINING CLAIMS-NOT NEW-UNADJUD, ONE AUTH NO. ONLY / MINING CLAIM MONEY RECEIVED CASES: AMC363059/\$109585.00	MAINT FEE PYMNT (707) 2015	- n/a -	109585.00
<b>TOTAL:</b>					<b>\$109,585.00</b>

PAYMENT INFORMATION					
1	AMOUNT:	109585.00	POSTMARKED:	08/02/2014	
	TYPE:	CHECK	RECEIVED:	08/07/2014	
	CHECK NO:	16999			
	NAME:	URANIUM ENERGY CORP 1111 W HASTINGS ST STE 320 VANCOUVER BC CANADA NS V6E 2J3 CA			

REMARKS

This receipt was generated by the automated BLM Collections and Billing System and is a paper representation of a portion of the official electronic record contained therein.



500 North Shoreline, Ste. 800N,  
Corpus Christi, TX 78401

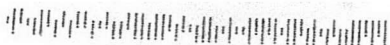

VITAL™

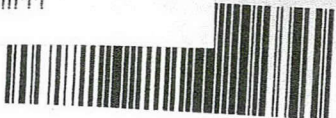

7010 0290 0001 8991 6052



UNITED STATES POSTAGE  
7.61  
DITNEY BOWEN  
02 1P \$ 007.61<sup>0</sup>  
0001765451 AUG 04 2014  
MAILED FROM ZIP CODE 78413

RECEIVED  
BLM AZ STATE OFFICE  
1 2014 AUG - 1 P 2 24  
PHOENIX, ARIZONA

Bureau of Land Management  
One North Central Avenue, Suite 800  
Phoenix, Arizona 85004



January 16, 2014

United States Department of the Interior  
Bureau of Land Management  
One N Central Ave  
Phoenix, AZ 85004

ATTN: Public Room

**RE: Claimant name and address change for mining claims**

To Whom It Concerns:

This is a formal request to change the claimant name from Concentric Energy Corp to Uranium Energy Corp for the 370 mining claims listed on the following pages. Included with this letter is the Merger Agreement between Concentric Energy Corp and Uranium Energy Corp, a list of the 370 affected mining claims, and a check in the amount of \$3,700 for the \$10/claim fee.

New Address

Uranium Energy Corp  
PO Box 2955  
Corpus Christi, TX 78403

Office: (361) 888-8235  
Fax: (361) 888-5041

If there are any questions or concerns, please contact me directly at [twilliams@uraniumenergy.com](mailto:twilliams@uraniumenergy.com) or (505) 803-5740.

Thank you,

Talitha Williams  
Office Manager

Enclosed

ENTERED  
JAN 24 2014  
BY: *JM*

5  
AT  
AMC 361520  
365258  
366483  
366751  
388128  
393473

RECEIVED  
BLM AZ STATE OFFICE  
2014 JAN 21 PM 4:00  
PHOENIX, ARIZONA



Uranium Energy Corp

Claim Name	BLM #	Township	Range	Section	Location Date
CE 1	AMC366751	11N	10W	11	5/4/2005
CE 2	AMC366752	11N	10W	11	5/4/2005
CE 3	AMC366753	11N	10W	11	5/4/2005
CE 4	AMC366754	11N	10W	11	5/4/2005
CE 5	AMC366755	11N	10W	11	5/4/2005
CE 6	AMC366756	11N	10W	11	5/4/2005
CE 7	AMC366757	11N	10W	11	5/8/2005
CE 8	AMC366758	11N	10W	10	5/8/2005
TH 1	AMC366759	11N	10W	10	5/8/2005
AM 1	AMC361520	11N	10W	15, 16	3/9/2004
AM 2	AMC361521	11N	10W	15	3/9/2004
AM 3	AMC361522	11N	10W	15, 16	3/9/2004
AM 4	AMC361523	11N	10W	15	3/9/2004
AM 5	AMC361524	11N	10W	15, 16	3/9/2004
AM 6	AMC361525	11N	10W	15	3/9/2004
AM 7	AMC361526	11N	10W	15, 16	3/9/2004
AM 8	AMC361527	11N	10W	15, 22	3/9/2004
AM 9	AMC361528	11N	10W	15, 16	3/9/2004
AM 10	AMC361529	11N	10W	15, 22	3/10/2004
AM 11	AMC361530	11N	10W	15, 16, 21, 22	3/10/2004
AM 12	AMC361531	11N	10W	22	3/10/2004
AM 13	AMC361532	11N	10W	21, 22	3/10/2004
AM 14	AMC361533	11N	10W	21, 22	3/10/2004
AM 15	AMC361534	11N	10W	21, 22	3/10/2004
AM 16	AMC361535	11N	10W	21, 22	3/10/2004
AM 17	AMC361536	11N	10W	21	3/10/2004
AM 18	AMC361537	11N	10W	21, 22	3/10/2004
AM 19	AMC361538	11N	10W	21	3/10/2004
AM 20	AMC361539	11N	10W	21, 22	3/11/2004
AM 21	AMC361540	11N	10W	21	3/11/2004
AM 22	AMC361541	11N	10W	21, 22	3/11/2004
AM 23	AMC361542	11N	10W	21	3/11/2004
AM 24	AMC361543	11N	10W	21, 22	3/11/2004
AM 25	AMC361544	11N	10W	15, 22	3/11/2004
AM 26	AMC361545	11N	10W	22	3/11/2004
AM 27	AMC361546	11N	10W	22	3/11/2004
AM 28	AMC361547	11N	10W	22	3/11/2004
AM 29	AMC361548	11N	10W	22	3/11/2004

2011 JUN 21 PM 4:00

RECEIVED  
BLM AZ STATE OFFICE



Uranium Energy Corp

AM 30	AMC361549	11N	10W	22	3/11/2004
AM 31	AMC361550	11N	10W	22	3/11/2004
AM 32	AMC361551	11N	10W	22	3/11/2004
AM 33	AMC361552	11N	10W	22	3/11/2004
AM 34	AMC361553	11N	10W	22	3/11/2004
AM 35	AMC361554	11N	10W	22	3/11/2004
AM 36	AMC361555	11N	10W	22	3/11/2004
AM 37	AMC361556	11N	10W	22	3/11/2004
AM 38	AMC361557	11N	10W	22	3/11/2004
AM 39	AMC361558	11N	10W	22	3/11/2004
AM 40	AMC361559	11N	10W	22, 27	3/11/2004
AM 41	AMC361560	11N	10W	22	3/11/2004
AM 42	AMC361561	11N	10W	22, 27	3/10/2004
AM 43	AMC361562	11N	10W	22, 27	3/10/2004
AM 44	AMC361563	11N	10W	27	3/10/2004
AM 45	AMC361564	11N	10W	27	3/10/2004
AM 46	AMC361565	11N	10W	11	3/10/2004
AM 47	AMC361566	11N	10W	11	3/10/2004
AM 48	AMC361567	11N	10W	11, 14	3/10/2004
AM 49	AMC361568	11N	10W	11	3/10/2004
AM 50	AMC361569	11N	10W	11, 14	3/10/2004
AM 51	AMC361570	11N	10W	11, 14	3/10/2004
AM 52	AMC361571	11N	10W	14	3/10/2004
AM 53	AMC361572	11N	10W	11, 14	3/10/2004
AM 54	AMC361573	11N	10W	14	3/10/2004
AM 55	AMC361574	11N	10W	14	3/10/2004
AM 56	AMC361575	11N	10W	14	3/10/2004
AM 57	AMC361576	11N	10W	14	3/10/2004
AM 58	AMC361577	11N	10W	14	3/10/2004
AM 59	AMC361578	11N	10W	14	3/10/2004
AM 60	AMC361579	11N	10W	14	3/10/2004
AM 61	AMC361580	11N	10W	14	3/10/2004
AM 62	AMC361581	11N	10W	14	3/10/2004
AM 63	AMC361582	11N	10W	14	3/10/2004
AM 64	AMC361583	11N	10W	14	3/10/2004
AM 65	AMC361584	11N	10W	14	3/10/2004
AM 66	AMC361585	11N	10W	14	3/10/2004
AM 67	AMC361586	11N	10W	14, 15	3/10/2004
AM 68	AMC361587	11N	10W	14, 23	3/10/2004
AM 69	AMC361588	11N	10W	14, 15, 23	3/10/2004
AM 70	AMC361589	11N	10W	23	3/11/2004

2004 JUN 21 PM 11:00

RECEIVED  
BLM AZ STATE OFFICE





Uranium Energy Corp

AM 71	AMC361590	11N	10W	14, 15, 22, 23	3/11/2004
AM 72	AMC361591	11N	10W	23	3/11/2004
AM 73	AMC361592	11N	10W	22, 23	3/11/2004
AM 74	AMC361593	11N	10W	23	3/11/2004
AM 75	AMC361594	11N	10W	22, 23	3/11/2004
AM 76	AMC361595	11N	10W	23	3/11/2004
AM 77	AMC361596	11N	10W	22, 23	3/11/2004
AM 78	AMC361597	11N	10W	23	3/11/2004
AM 79	AMC361598	11N	10W	22, 23	3/11/2004
AM 80	AMC361599	11N	10W	23	3/11/2004
AM 81	AMC361600	11N	10W	22, 23	3/11/2004
AM 82	AMC361601	11N	10W	23	3/11/2004
AM 83	AMC361602	11N	10W	23	3/11/2004
AM 84	AMC361603	11N	10W	23	3/11/2004
AM 85	AMC361604	11N	10W	22, 23	3/11/2004
AM 86	AMC361605	11N	10W	22, 23, 26, 27	3/11/2004
AM 87	AMC361606	11N	10W	22, 27	3/11/2004
AM 88	AMC361607	11N	10W	26, 27	3/11/2004
AM 89	AMC361608	11N	10W	22, 27	3/11/2004
AM 90	AMC361609	11N	10W	26, 27	3/11/2004
AM 91	AMC361610	11N	10W	27	3/11/2004
AM 92	AMC361611	11N	10W	26, 27	3/11/2004
AM 93	AMC361612	11N	10W	27	3/11/2004
AM 94	AMC361613	11N	10W	26, 27	3/11/2004
AM 95	AMC361614	11N	10W	27	3/11/2004
AM 96	AMC361615	11N	10W	26, 27	3/11/2004
AM 97	AMC361616	11N	10W	27	3/11/2004
AM 98	AMC361617	11N	10W	26, 27	3/11/2004
AM 99	AMC361618	11N	10W	27	3/11/2004
AM 100	AMC361619	11N	10W	26, 27	3/11/2004
AM 101	AMC361620	11N	10W	27	3/11/2004
AM 102	AMC361621	11N	10W	26, 27	3/11/2004
AM 103	AMC361622	11N	10W	27	3/11/2004
AM 104	AMC361623	11N	10W	26, 27, 34	3/11/2004
AM 105	AMC361624	11N	10W	11, 12	3/14/2004
AM 106	AMC361625	11N	10W	12, 13	3/14/2004
AM 107	AMC361626	11N	10W	11, 12, 13, 14	3/14/2004
AM 108	AMC361627	11N	10W	12, 13	3/14/2004
AM 109	AMC361628	11N	10W	13, 14	3/14/2004

2004 MAR 21 PM 11:00

RECEIVED  
BLM AZ STATE OFFICE



Uranium Energy Corp

AM 110	AMC361629	11N	10W	13	3/14/2004
AM 111	AMC361630	11N	10W	13, 14	3/14/2004
AM 112	AMC361631	11N	10W	13	3/14/2004
AM 113	AMC361632	11N	10W	13, 14	3/14/2004
AM 114	AMC361633	11N	10W	13	3/14/2004
AM 115	AMC361634	11N	10W	13, 14	3/14/2004
AM 116	AMC361635	11N	10W	13, 14	3/14/2004
AM 117	AMC361636	11N	10W	14	3/14/2004
AM 118	AMC361637	11N	10W	13, 14	3/14/2004
AM 119	AMC361638	11N	10W	14	3/14/2004
AM 120	AMC361639	11N	10W	13, 14	3/14/2004
AM 121	AMC361640	11N	10W	14	3/14/2004
AM 122	AMC361641	11N	10W	13, 14	3/14/2004
AM 123	AMC361642	11N	10W	14	3/11/2004
AM 124	AMC361643	11N	10W	13, 14, 24	3/11/2004
AM 125	AMC361644	11N	10W	14, 23	3/11/2004
AM 126	AMC361645	11N	10W	13, 14, 24	3/11/2004
AM 127	AMC361646	11N	10W	23	3/11/2004
AM 128	AMC361647	11N	10W	23, 24	3/11/2004
AM 129	AMC361648	11N	10W	23	3/11/2004
AM 130	AMC361649	11N	10W	23, 24	3/11/2004
AM 131	AMC361650	11N	10W	23	3/11/2004
AM 132	AMC361651	11N	10W	23, 24	3/11/2004
AM 133	AMC361652	11N	10W	23	3/11/2004
AM 134	AMC361653	11N	10W	23	3/11/2004
AM 135	AMC361654	11N	10W	23	3/11/2004
AM 136	AMC361655	11N	10W	23	3/11/2004
AM 137	AMC361656	11N	10W	23	3/11/2004
AM 138	AMC361657	11N	10W	23	3/11/2004
AM 139	AMC361658	11N	10W	23	3/11/2004
AM 140	AMC361659	11N	10W	23	3/11/2004
AM 141	AMC361660	11N	10W	23	3/11/2004
AM 142	AMC361661	11N	10W	23, 26	3/11/2004
AM 143	AMC361662	11N	10W	23, 26	3/11/2004
AM 144	AMC361663	11N	10W	23, 26	3/11/2004
AM 145	AMC361664	11N	10W	23, 26	3/11/2004
AM 146	AMC361665	11N	10W	26	3/11/2004
AM 147	AMC361666	11N	10W	26	3/11/2004
AM 148	AMC361667	11N	10W	26	3/11/2004
AM 149	AMC361668	11N	10W	26	3/11/2004
AM 150	AMC361669	11N	10W	26	3/11/2004

2011 JAN 21 PM 11:00

RECEIVED  
BLM AZ STATE OFFICE



Uranium Energy Corp

AM 151	AMC361670	11N	10W	26	3/11/2004
AM 152	AMC361671	11N	10W	26	3/11/2004
AM 153	AMC361672	11N	10W	26	3/14/2004
AM 154	AMC361673	11N	10W	26	3/14/2004
AM 155	AMC361674	11N	10W	26	3/14/2004
AM 156	AMC361675	11N	10W	26	3/14/2004
AM 157	AMC361676	11N	10W	26	3/14/2004
AM 158	AMC361677	11N	10W	26	3/14/2004
AM 159	AMC361678	11N	10W	26	3/14/2004
AM 160	AMC361679	11N	10W	26, 35	3/14/2004
AM 161	AMC361680	11N	10W	26, 35	3/14/2004
AM 162	AMC361681	11N	10W	26, 35	3/14/2004
AM 163	AMC361682	11N	10W	12, 13	3/13/2004
AM 164	AMC361683	11N	10W	13	3/13/2004
AM 165	AMC361684	11N	10W	13	3/13/2004
AM 166	AMC361685	11N	10W	13	3/13/2004
AM 167	AMC361686	11N	10W	13	3/13/2004
AM 168	AMC361687	11N	10W	13	3/13/2004
AM 169	AMC361688	11N	10W	13	3/13/2004
AM 170	AMC361689	11N	10W	13	3/13/2004
AM 171	AMC361690	11N	10W	13	3/13/2004
AM 172	AMC361691	11N	10W	13	3/13/2004
AM 173	AMC361692	11N	10W	13	3/13/2004
AM 174	AMC361693	11N	10W	13	3/13/2004
AM 175	AMC361694	11N	10W	13	3/13/2004
AM 176	AMC361695	11N	10W	13	3/13/2004
AM 177	AMC361696	11N	10W	13	3/13/2004
AM 178	AMC361697	11N	10W	13	3/13/2004
AM 179	AMC361698	11N	10W	13	3/13/2004
AM 180	AMC361699	11N	10W	13, 24	3/13/2004
AM 181	AMC361700	11N	10W	13, 24	3/13/2004
AM 182	AMC361701	11N	10W	24	3/13/2004
AM 183	AMC361702	11N	10W	24	3/13/2004
AM 184	AMC361703	11N	10W	24	3/13/2004
AM 185	AMC361704	11N	10W	24	3/13/2004
AM 186	AMC361705	11N	10W	24	3/13/2004
AM 187	AMC361706	11N	10W	24	3/13/2004
AM 188	AMC361707	11N	10W	24	3/13/2004
AM 189	AMC361708	11N	10W	24	3/13/2004
AM 190	AMC361709	11N	10W	24	3/13/2004
AM 191	AMC361710	11N	10W	23, 24	3/13/2004

2011 Mar 21 PM 4:00

RECEIVED  
BLM AZ STATE OFFICE



Uranium Energy Corp

AM 192	AMC361711	11N	10W	24	3/13/2004
AM 193	AMC361712	11N	10W	23, 24	3/13/2004
AM 194	AMC361713	11N	10W	24	3/13/2004
AM 195	AMC361714	11N	10W	23, 24	3/13/2004
AM 196	AMC361715	11N	10W	24	3/13/2004
AM 197	AMC361716	11N	10W	23, 24	3/13/2004
AM 198	AMC361717	11N	10W	24, 25	3/13/2004
AM 199	AMC361718	11N	10W	23, 24, 25, 26	3/13/2004
AM 200	AMC361719	11N	10W	24, 25	3/13/2004
AM 201	AMC361720	11N	10W	25, 26	3/13/2004
AM 202	AMC361721	11N	10W	25	3/13/2004
AM 203	AMC361722	11N	10W	25, 26	3/13/2004
AM 204	AMC361723	11N	10W	25	3/13/2004
AM 205	AMC361724	11N	10W	25, 26	3/13/2004
AM 206	AMC361725	11N	10W	25	3/13/2004
AM 207	AMC361726	11N	10W	25, 26	3/13/2004
AM 208	AMC361727	11N	10W	25	3/13/2004
AM 209	AMC361728	11N	10W	25, 26	3/13/2004
AM 210	AMC361729	11N	10W	25, 26	3/13/2004
AM 211	AMC361730	11N	10W	25, 26	3/13/2004
AM 212	AMC361731	11N	10W	25, 26	3/13/2004
AM 213	AMC361732	11N	10W	25, 26	3/13/2004
AM 214	AMC361733	11N	10W	25, 26	3/13/2004
AM 215	AMC361734	11N	10W	25, 26	3/13/2004
AM 216	AMC361735	11N	10W	25, 26, 36	3/13/2004
AM 217	AMC388128	11N	10W	9, 10	11/12/2007
AM 218	AMC388129	11N	10W	9, 10	11/12/2007
AM 219	AMC388130	11N	10W	9, 10	11/12/2007
AM 220	AMC388131	11N	10W	10	11/12/2007
AM 221	AMC388132	11N	10W	10	11/12/2007
AM 222	AMC388133	11N	10W	10	11/12/2007
AM 223	AMC388134	11N	10W	3, 10	11/12/2007
AM 224	AMC388135	11N	10W	10	11/12/2007
AM 225	AMC388136	11N	10W	3	11/12/2007
AM 226	AMC388137	11N	10W	3	11/12/2007
AM 227	AMC388138	11N	10W	3	11/12/2007
AM 228	AMC388139	11N	10W	3	11/12/2007
AM 229	AMC388140	11N	10W	3	11/12/2007
AM 230	AMC388141	11N	10W	3	11/12/2007
AM 231	AMC388142	11N	10W	10, 11	11/12/2007
AM 232	AMC388143	11N	10W	11	11/12/2007

2011 MAR 21 PM 11:00

RECEIVED  
ELM AZ STATE OFFICE



Uranium Energy Corp

AM 233	AMC388144	11N	10W	10, 11	11/12/2007
AM 234	AMC388145	11N	10W	11	11/12/2007
AM 235	AMC388146	11N	10W	2, 3, 10, 11	11/12/2007
AM 236	AMC388147	11N	10W	11	11/12/2007
AM 237	AMC388148	11N	10W	2, 3, 11	11/12/2007
AM 238	AMC388149	11N	10W	2, 11	11/12/2007
AM 239	AMC388150	11N	10W	11	10/30/2007
AM 240	AMC388151	11N	10W	11	10/30/2007
AM 241	AMC388152	11N	10W	11	10/30/2007
AM 242	AMC388153	11N	10W	11	10/30/2007
AM 243	AMC388154	11N	10W	11	10/30/2007
AM 244	AMC388155	11N	10W	11	10/30/2007
AM 245	AMC388156	11N	10W	11	10/30/2007
AM 246	AMC361736	11N	10W	10	3/16/2004
AM 247	AMC361737	11N	10W	10	3/16/2004
AM 248	AMC361738	11N	10W	10,11	3/16/2004
AM 249	AMC361739	11N	10W	11	3/16/2004
AM 250	AMC361740	11N	10W	11	3/10/2004
AM 251	AMC361741	11N	10W	11	3/10/2004
AM 252	AMC361742	11N	10W	11	3/10/2004
AM 253	AMC361743	11N	10W	11	3/10/2004
AM 254	AMC361744	11N	10W	9, 15, 16	3/12/2004
AM 255	AMC361745	11N	10W	9, 16	3/12/2004
AM 256	AMC361746	11N	10W	9, 10, 15	3/12/2004
AM 257	AMC361747	11N	10W	9	3/12/2004
AM 258	AMC361748	11N	10W	9, 10	3/12/2004
AM 259	AMC361749	11N	10W	9	3/12/2004
AM 260	AMC361750	11N	10W	9, 10	3/12/2004
AM 261	AMC361751	11N	10W	9	3/12/2004
AM 262	AMC361752	11N	10W	9, 10	3/12/2004
AM 263	AMC361753	11N	10W	9	3/12/2004
AM 264	AMC361754	11N	10W	27, 34	3/11/2004
AM 265	AMC365258	11N	10W	10, 11	2/2/2005
AM 266	AMC365259	11N	10W	11	2/2/2005
AM 267	AMC365260	11N	10W	10, 11	2/2/2005
AM 268	AMC365261	11N	10W	10, 11	2/2/2005
AM 269	AMC365262	11N	10W	10, 11	2/2/2005
AM 270	AMC365263	11N	10W	10, 11	2/2/2005
AM 271	AMC365264	11N	10W	10, 11, 15	2/2/2005
AM 272	AMC365265	11N	10W	10, 11, 14, 15	2/2/2005
AM 273	AMC365266	11N	10W	10, 15	2/2/2005

2014 JAN 21 PM 4: 01

RECEIVED  
BLM AZ STATE OFFICE

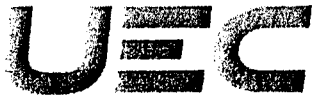

Uranium Energy Corp

AM 274	AMC365267	11N	10W	14, 15	2/2/2005
AM 275	AMC365268	11N	10W	15	2/2/2005
AM 276	AMC365269	11N	10W	14, 15	2/2/2005
AM 277	AMC365270	11N	10W	15	2/2/2005
AM 278	AMC365271	11N	10W	14, 15	2/2/2005
AM 279	AMC365272	11N	10W	15	2/2/2005
AM 280	AMC365273	11N	10W	14, 15	2/2/2005
AM 281	AMC365274	11N	10W	15	2/2/2005
AM 282	AMC365275	11N	10W	14, 15	2/2/2005
AM 283	AMC365276	11N	10W	15	2/2/2005
AM 284	AMC365277	11N	10W	14, 15	2/2/2005
AM 285	AMC365278	11N	10W	15	2/2/2005
AM 286	AMC365279	11N	10W	14, 15	2/2/2005
AM 287	AMC365280	11N	10W	10	2/3/2005
AM 288	AMC365281	11N	10W	10	2/3/2005
AM 289	AMC365282	11N	10W	10	2/3/2005
AM 290	AMC365283	11N	10W	10	2/3/2005
AM 291	AMC365284	11N	10W	10	2/3/2005
AM 292	AMC365285	11N	10W	10, 15	2/3/2005
AM 293	AMC365286	11N	10W	10, 15	2/3/2005
AM 294	AMC365287	11N	10W	10, 15	2/3/2005
AM 295	AMC365288	11N	10W	15	2/3/2005
AM 296	AMC365289	11N	10W	15	2/3/2005
AM 297	AMC365290	11N	10W	15, 16	2/3/2005
AM 298	AMC365291	11N	10W	15	2/3/2005
AM 299	AMC365292	11N	10W	15, 16	2/3/2005
AM 300	AMC365293	11N	10W	15	2/3/2005
AM 301	AMC365294	11N	10W	15	2/3/2005
AM 302	AMC366483	11N	10W	9, 10	7/11/2005
AM 303	AMC366484	11N	10W	10	7/11/2005
AM 304	AMC366485	11N	10W	10	7/11/2005
AM 305	AMC366486	11N	10W	10	7/11/2005
AM 306	AMC366487	11N	10W	10	7/11/2005
AM 307	AMC366488	11N	10W	10	7/11/2005
AM 308	AMC366489	11N	10W	10, 11	7/11/2005
AM 309	AMC366490	11N	10W	11	7/11/2005
AM 310	AMC388157	11N	10W	11, 12	10/30/2007
AM 311	AMC388158	11N	10W	2, 11	10/30/2007
AM 312	AMC388159	11N	10W	2, 11, 12	10/30/2007
AM 313	AMC388160	11N	10W	1, 2, 11, 12	10/30/2007
AM 314	AMC388161	11N	10W	12	10/30/2007

2014 JAN 21 PM 4:01

RECEIVED  
BLM AZ STATE OFFICE

6  
Page 4



Uranium Energy Corp

AM 315	AMC388162	11N	10W	12	10/30/2007
AM 316	AMC388163	11N	10W	12	10/30/2007
AM 317	AMC388164	11N	10W	11, 12	11/12/2007
AM 318	AMC388165	11N	10W	12	11/12/2007
AM 319	AMC388166	11N	10W	11, 12	10/30/2007
AM 320	AMC388167	11N	10W	12	11/12/2007
AM 321	AMC388168	11N	10W	11, 12	10/30/2007
AM 322	AMC388169	11N	10W	12	11/12/2007
AM 323	AMC388170	11N	10W	11, 12	10/30/2007
AM 324	AMC388171	11N	10W	12	11/12/2007
AM 325	AMC388172	11N	10W	13	10/30/2007
AM 326	AMC388173	11N	10W	13	10/30/2007
AM 327	AMC388174	11N	9W/10W	18/13	10/30/2007
AM 328	AMC388175	11N	9W/10W	18, 19/13, 24	10/30/2007
AM 329	AMC388176	11N	9W	18, 19	10/30/2007
AM 330	AMC388177	11N	10W	13, 24	10/30/2007
AM 331	AMC388178	11N	9W/10W	19/ 24	10/30/2007
AM 332	AMC388179	11N	10W	24	10/30/2007
AM 333	AMC388180	11N	9W/10W	19/ 24	10/30/2007
AM 334	AMC388181	11N	10W	24	10/30/2007
AM 335	AMC388182	11N	9W/10W	19/ 24	10/30/2007
AM 336	AMC388183	11N	10W	24	10/30/2007
AM 337	AMC388184	11N	9W/10W	19/ 24	10/30/2007
AM 338	AMC388185	11N	10W	24	10/30/2007
AM 339	AMC388186	11N	9W/10W	19/ 24	10/30/2007
AM 340	AMC388187	11N	10W	24	10/30/2007
AM 341	AMC388188	11N	9W/10W	19/ 24	10/30/2007
AM 342	AMC388189	11N	10W	24	10/30/2007
AM 343	AMC388190	11N	9W/10W	19/ 24	10/30/2007
AM 344	AMC388191	11N	10W	24	10/30/2007
AM 345	AMC388192	11N	9W/10W	19/ 24	10/30/2007
AM 346	AMC388193	11N	10W	24, 25	10/30/2007
AM 347	AMC388194	11N	9W/10W	19, 30/24, 25	10/30/2007
AM 348	AMC388195	11N	10W	24, 25	10/30/2007
AM 349	AMC388196	11N	10W	25	10/30/2007
AM 350	AMC388197	11N	10W	25	10/30/2007
AM 351	AMC388198	11N	10W	25	10/30/2007
AM 352	AMC388199	11N	10W	25	10/30/2007
AM 353	AMC388200	11N	10W	25	10/30/2007
AM 354	AMC388201	11N	10W	25	10/30/2007

RECEIVED  
BLM AZ STAFF OFFICE



Uranium Energy Corp

AM 355	AMC388202	11N	10W	25	10/30/2007
AM 356	AMC388203	11N	10W	25	10/30/2007
AM 357	AMC388204	11N	10W	25	10/30/2007
AM 358	AMC393473	11N	10W	21	6/12/2008
AM 359	AMC393474	11N	10W	21	6/12/2008
AM 360	AMC393475	11N	10W	21	6/12/2008
AM 361	AMC393476	11N	10W	21	6/12/2008

RECEIVED  
BLM AZ STATE OFFICE  
2014 JAN 21 PM 4: 01  
PHOENIX, ARIZONA



**MERGER AGREEMENT & PLAN OF MERGER**

Between:

URANIUM ENERGY CORP.

And:

CONCENTRIC ENERGY CORP.

— BY D.

# MERGER AGREEMENT & PLAN OF MERGER

THIS MERGER AGREEMENT AND PLAN OF MERGER is made and dated for reference as at May 5, 2011 (the "Execution Date").

## BETWEEN:

URANIUM ENERGY CORP., a company incorporated under the laws of the State of Nevada, U.S.A., and having an address for notice and delivery located at 500 North Shoreline, Suite 800N, Corpus Christi, Texas, U.S.A., 78401

("UEC");

## OF THE FIRST PART

## AND:

CONCENTRIC ENERGY CORP., a company incorporated under the laws of the State of Nevada, U.S.A., and having an address for notice and delivery located at 17318 De Chirico Circle, Spring, Texas, U.S.A., 77379

("Concentric").

## OF THE SECOND PART

NOW THEREFORE THIS AGREEMENT WITNESSETH that in consideration of the mutual promises, covenants and agreements herein contained, THE PARTIES HERETO COVENANT AND AGREE WITH EACH OTHER as follows:

## PART I INTERPRETATION

### Definitions

1.1 In this Agreement, unless there is something in the subject matter or context inconsistent therewith, the following terms shall have the following meanings respectively:

- (a) "1933 Act" means the United States *Securities Act of 1933*, as amended;
- (b) "Affiliate" has the meaning ascribed thereto in Rule 405 under the 1933 Act unless otherwise expressly stated herein;
- (c) "Ancillary Agreements" means all agreements, if any, to be negotiated and executed by Concentric and others which are determined by Concentric and UEC to be reasonably necessary to permit the transactions contemplated herein after the Execution Date but before the Closing to be concluded and including, without

"**Articles of Merger**" has the meaning ascribed to it in §2.1;

"**Assets**" means all properties, assets, privileges, rights, interests and claims, real and personal, tangible and intangible, of every type and description, wherever located, owned, leased or licensed by Concentric or by UEC, as the context so requires;

"**Business**" means, in respect of Concentric, the business currently carried on by Concentric as of the Execution Date and including activities carried on, directly and indirectly, in connection with the exploration for, and the acquisition and development of, uranium properties in the United States, and, in respect of UEC, means the business currently carried on by UEC as of the Execution Date and including activities carried on by UEC, directly and indirectly, in connection with the exploration for, and the acquisition and development of, uranium properties in the United States;

"**Business Day**" means any day on which commercial banks are generally open for business in Vancouver, British Columbia, Canada, and the State of Nevada, United States;

(h) "**Closing**" means the completion of the Merger and the closing of all other transactions expressly contemplated by this Agreement to complete concurrently therewith;

"**Commission**" means the United States Securities and Exchange Commission;

"**Concentric Disclosure Schedule**" means the disclosure schedule dated the Execution Date of this Agreement regarding this Agreement that has been provided by Concentric to UEC as a necessary condition of UEC entering into this Agreement; and the details of which Concentric Disclosure Schedule being expressly relied upon by UEC as a condition of its execution of this Agreement;

"**Concentric Dissent Rights**" means the rights of any Concentric Shareholders to dissent pursuant to the Nevada Statutes with respect to the Merger;

"**Concentric Financial Statements**" means the audited annual financial statements of Concentric and the unaudited interim financial statements of Concentric;

(m) "**Concentric Meeting**" means the special meeting of Concentric Shareholders, including any adjournment thereof, to be called and held for the purpose of considering and approving the Merger;

"**Concentric Merger Resolutions**" means the consent resolutions of the Concentric Shareholders to ratify this Agreement and to approve the Merger and to be substantially in the form and content of Schedule A annexed hereto;

"**Concentric Shares**" means the shares of issued and outstanding common stock in the capital of Concentric as constituted on the Execution Date;

- (p) **"Concentric Shareholders"** means holders of record of Concentric Shares, and in the singular means any holder of record of Concentric Shares;
- (q) **"Concentric Warrants"** means those outstanding warrants to acquire Concentric Shares as set out in Section 4.1(b)(i) of the Concentric Disclosure Schedule;
- (r) **"Concentric's Lawyers"** means Schlanger, Silver, Barg & Paine, L.L.P., of 109 North Post Oak Lane, Suite 300, Houston, Texas, U.S.A., 77024;
- (s) **"Dissenting Shares"** means those Concentric Shares of which the holders thereof have properly and timely complied with the Nevada Statutes as to dissenters' rights;
- (t) **"Effective Date"** has the meaning ascribed to it in §8.1;
- (u) **"Effective Time"** means 12:01 a.m. (Nevada, U.S.A., time) on the Effective Date;
- (v) **"Encumbrance"** means any actual or threatened lien, mortgage, charge, pledge, hypothecation, security interest, assignment, option, equity, execution, claim or any other title defect or other encumbrance of any kind or nature whatsoever (including any agreement to give any of the foregoing) whether or not registered or registrable or whether consensual or arising by operation of law (statutory or otherwise);  
  
**"Environmental Laws"** means all applicable Laws relating to the protection of the environment and public health and safety and including, without limitation, applicable common law, the United States *Clean Air Act*, the *Comprehensive Environmental Response Compensation and Liability Act*, the *Resource Conservation and Recovery Act of 1976*, the *Toxic Substances Control Act*, the *Safe Drinking Water Act* and the *Hazardous Materials Transportation Act*, all as amended, and any state Laws implementing or analogous to the foregoing federal Laws, and all other Laws relating to or regulating emissions, discharges, releases, or cleanup of pollutants, contaminants, uranium exploration and production wastes, solid wastes, or toxic or Hazardous Substances or wastes;
- (x) **"Exchange Ratio"** means the ratio which determines the number of UEC Shares that are to be issued on completion of the Merger for all of the Concentric Shares, subject to reduction by any Dissenting Shares, and which Exchange Ratio, as of the Execution Date of this Agreement, is **0.1075** of one UEC Share for one Concentric Share; provided, however, that the Exchange Ratio may be adjusted by good faith negotiation between the Parties if required having regard to the results of the due diligence investigation of a party's Business and affairs by the other party; and provided further that either Party may terminate this Agreement in the event such due diligence results warrant the conversion of the Concentric Shares into more than 1,253,440 UEC Shares, it being agreed that not more than 1,253,440 UEC Shares shall be issued in exchange for Concentric Shares pursuant to the Merger (exclusive of any UEC Shares issued in exchange for Concentric Shares which are issued upon exercise prior to Closing of any Concentric Warrants);
- (y) **"Global Acquisition Agreement"** means that certain "Acquisition Agreement", dated for reference April 11, 2011, as entered into between UEC and Global Uranium Corp. ("Global") as a condition of entering into this Agreement; and pursuant to UEC has agreed, contemporaneously with the completion of the

(i)

ry

documents, records, correspondence and other information pertaining to Concentric;

- (ae) "**Involuntary Bankruptcy Petition**" means that certain and existing involuntary bankruptcy petition (In re: Concentric Energy Corp., Debtor, Chapter 7, Case No. 10-bk-18796-SSC) as filed in the United States Bankruptcy Court 2 in and for the District of Arizona, by the petitioning creditors, AWM Holding, LLC, Blue Sky Securities Ltd., David R. Holbrooke, Richard Louise, Timothy M. Schmidt, and John P. O'Shea, against the debtor, Concentric;
- (af) "**Kettell Arrangement**" means that certain form of anticipated consulting services arrangement which is intended to be entered into between UEC and Ralph Kettell, a present director of Concentric, as soon as reasonably practicable after the Execution Date, and representing Mr. Kettell's agreement to provide certain consulting services to UEC after the completion of the Merger and for consideration from UEC to be evidenced thereby;
- (ag) "**Laws**" means all statutes, regulations, statutory rules, orders, policies and terms and conditions of any grant of approval, permission, authority or license of any court and Governmental Entity, and the term "**applicable**" with respect to such Laws, and in the context that refers to one or more Persons, means that such Laws apply to such Person or Persons or its or their business, undertaking, property or securities and emanate from a Governmental Entity having jurisdiction over the Person or Persons or its or their business, undertaking, property or securities;
- (ah) "**Lock-Up Agreements**" means those certain "Lock-up and Pooling Agreement's" and "Lock-Up Agreement's" to be entered into between UEC and certain Concentric Shareholders; representing not less than 50.1% of all Concentric Shares on a non-fully diluted basis; as soon as reasonably practicable after the Execution Date and representing the agreement of each such Concentric Shareholder to, in part, deposit or cause to be deposited under, and not withdraw or cause to be withdrawn from the Merger, their Concentric Shares, to vote or cause to be voted their Concentric Shares in favour of the Merger and any other matter that could reasonably be expected to facilitate the Merger and to abide by the restrictions and covenants set forth therein; and the form of which Lock-Up Agreements having been agreed to in advance as between the Parties and also forming part of the Ancillary Agreements hereunder;

"**Material Adverse Change**", when used in connection with either Concentric or UEC, means any change, effect, event or occurrence with respect to its condition (financial or otherwise), properties, assets, liabilities, obligations (whether absolute, accrued, conditional or otherwise), businesses, operations or results of operations that is, or would reasonably be expected to be, material and adverse to the business, operations or financial condition of such Party taken as a whole, other than any change, effect, event or occurrence relating to the Canadian, or United States' economy or securities markets in general;

"**Material Adverse Effect**", when used in connection with either Concentric or UEC, means any effect that is, or would reasonably be expected to be, material and adverse to the business, operations or financial condition of such Party taken as a whole;

(iii)

of

at

of

(G)

"Merger" means the merger of Concentric with and into Subco; with Subco being a wholly-owned subsidiary of LFC; on the terms and conditions herein provided

(am)

- (ap) **"Parties"** or **"Party"** means, respectively, collectively and individually, as the context so requires, each of UEC or Concentric as the case may be, together with their respective successors and permitted assigns as the context so requires;
- (aq) **"Person"** includes any individual, firm, partnership, joint venture, venture capital fund, limited liability company, unlimited liability company, association, trust, trustee, executor, administrator, legal personal representative, estate, group, body corporate, corporation, unincorporated association or organization, Governmental Entity, syndicate or other entity, whether or not having legal status;



- (bb) "**Surviving Corporation**" means Subco;
- (bc) "**Taxes**" means, in respect of a Party and its Affiliates, all federal, state, provincial, municipal, foreign or other taxes, imposts, rates, levies, assessments and government fees, and any other charges lawfully levied, assessed or imposed against it and including, without limitation, all income, capital gains, sales, excise, capital, real property, goods and services, business transfer and value added taxes, customs and import duties, together with all interests, fines and penalties with respect thereto;
- (bd) "**this Agreement**", "**hereto**", "**hereunder**", "**hereof**", "**herein**", "**hereby**" and similar expressions mean or refer to this Merger Agreement and any agreement, deed or instrument supplemental or ancillary hereto, and the expressions "**article**", "**section**", "**subsection**", "**paragraph**", "**subparagraph**", "**clause**" and "**subclause**" followed by a number mean the specified article, section, subsection, paragraph, subparagraph, clause or subclause of this Agreement;
- (be) "**Termination Date**" means August 31, 2011, or such later date as may be mutually agreed by the Parties to this Agreement;
- (bf) "**UEC Exchange Warrants**" has the meaning ascribed to it in §2.2(d);
- (bg) "**UEC Financial Statements**" means the audited annual financial statements of UEC and the unaudited interim financial statements of UEC included in the UEC SEC Filings;
- (bh) "**UEC Merger Resolutions**" means the consent resolutions of the Board of Directors of UEC (and UEC as the sole shareholder of Subco) to ratify this

(b)

P Y E.

Entire Agreement

F

g

shall automatically be cancelled and shall cease to exist, and each holder of a certificate representing any Concentric Shares shall cease to have any rights with respect thereto, except the right to receive the UEC Shares to be issued in consideration therefor upon surrender of such certificate, without interest;

each Concentric Share held in the treasury of Concentric immediately prior to the Effective Time shall be cancelled without any conversion thereof and no payment or distribution shall be made with respect thereto;

notwithstanding anything in this Agreement to the contrary, if, between the Execution Date of this Agreement and the Effective Time, the Exchange Ratio has been agreed upon in writing by Concentric and UEC, and thereafter the outstanding UEC Shares shall have been changed into a different number of shares or a different class by reason of any reclassification, recapitalization, split-up, combination, exchange of shares or readjustment, or a stock dividend thereon shall have been declared with a record date within such period, the Exchange Ratio shall be correspondingly adjusted;

all of the Concentric Warrants then outstanding will thereby be disposed of by the holders thereof in consideration for the issue of non-transferable common stock purchase warrants of UEC (the "UEC Exchange Warrants") to the persons set out in Section 4.1(b)(i) of the Concentric Disclosure Schedule, subject to reduction for any Concentric Warrants that are exercised or expire prior to Closing. The number of UEC Exchange Warrants issuable shall be determined with reference to the Exchange Ratio, *mutatis mutandis*. As of the Execution Date of this Agreement, the Exchange Ratio is 0.1075 of one UEC Share for every one Concentric Share. Accordingly, assuming the Exchange Ratio is the same at the Effective Time, a Concentric Warrant to acquire one Concentric Share would result in a UEC Warrant to acquire 0.1075 of one UEC Share, and the exercise price of each UEC Exchange Warrant shall be determined by dividing the per share exercise price of the corresponding whole Concentric Warrants by the Exchange Ratio. No fractional UEC Exchange Warrants will be issued, and any fractions of 0.5 and more in respect of each holder's aggregate Concentric Warrants shall be rounded off to the nearest whole UEC Exchange Warrant (so that no Concentric Warrant holder will receive more than one UEC Exchange Warrant in lieu of a fractional warrant in respect of such Concentric Warrant holder's entire holdings); and

Subco will be the Surviving Corporation and, upon the Effective Time, shall continue in existence and without further transfer shall succeed to and possess all rights, privileges, powers and franchises of Concentric and all of the assets and property of whatever kind and character of Concentric shall vest in Subco as the Surviving Corporation. Subco, as the Surviving Corporation, shall also be liable for all of the liabilities and obligations of Concentric, and any claim or judgment against Concentric may be enforced against Subco as the Surviving Corporation.

### Resale Restrictions

2.3 The UEC Shares issued to Concentric Shareholders in the Merger and the UEC Exchange Warrants will be registered under the Registration Statement. Any UEC Shares issued in the event of exercise of the UEC Exchange Warrants will not be registered under the Registration Statement and, upon issuance, will constitute "restricted securities" as defined in Rule 144(a)(3) under the 1933 Act.

### **Shareholders' Rights Upon Merger**

2.4 Upon consummation of the Merger each Concentric Shareholder shall, subject to applicable Laws and this Agreement, cease to have any rights with respect to any share certificate evidencing the Concentric Shareholder's title to one or more Concentric Shares, and to any Concentric Shares evidenced thereby, other than the right to receive a share certificate for UEC Shares.

### **Surrender of Certificates**

2.5 In connection with the Closing, UEC will issue UEC Share certificates evidencing the UEC Shares to be issued to Concentric Shareholders in the Merger on substantially the same basis as the Concentric Shares are registered as of the Effective Time. That is, Concentric Shares registered in the names of direct beneficial holders will be so registered and Concentric Shares registered in the name of brokerages, clearing houses and other intermediaries will be registered in those names, either in paper or in electronic form as the UEC Transfer Agent may advise. The UEC Transfer Agent shall, before issuing a UEC Share certificate in the name of a direct beneficial Concentric Shareholder, require the delivery to the UEC Transfer Agent of the Concentric Share certificates which are outstanding and registered in such Concentric shareholder's name, duly endorsed for transfer in blank, but the UEC Transfer Agent shall institute standard procedures in connection with Concentric Shares registered in the names of brokerages, clearing houses and other intermediaries where such Concentric Shares are book-based.

### **By-Laws**

2.6 After the Merger the by-laws of Subco shall be the by-laws of the Surviving Corporation; provided however, the obligations of UEC under §5.7 hereof shall remain in full force and effect as set forth in such §5.7.

### **Effects of Merger**

2.7 The Merger shall have all further effects as specified in the applicable provisions of the Nevada Statutes and the Articles of Merger.

### **Additional Actions**

2.8 If, at any time after the Merger, UEC shall determine that the Surviving Corporation requires that any deeds, bills of sale, assignments, assurances or any other actions or things are necessary or desirable to vest, perfect or confirm of record or otherwise in the Surviving Corporation its right, title or interest in, to or under any of the rights, properties or Assets of Concentric or otherwise to carry out this Agreement, the officers and directors of the Surviving Corporation shall be authorized to execute and deliver, in the name and on behalf of Concentric, all such deeds, bills of sale, assignments and assurances and to take and do, in the name and on behalf of Concentric, all such other actions and things as may be necessary or desirable to vest, perfect or confirm any and all right, title and interest in, to and under such rights, properties or Assets in the Surviving Corporation or otherwise to carry out this Agreement and the transactions contemplated hereby.

### **No Tax Representations of UEC**

2.9 No representation is made by UEC in regards to the tax treatment of the Merger for Concentric Shareholders or Concentric Warrant holders.

No Tax Representations of Concentric

PART 3  
IMPLEMENTATION OF THE MERGER

Implementation Steps by Concentric

3.1 Concentric covenants in favor of UEC that Concentric shall:

(a)

(b)

o p y

(b)

D

D

G

3 UEC and Concentric shall co-operate in:  
the preparation of the Registration Statement and related Proxy Statement; and  
the preparation of any application for any regulatory approvals, other orders, rulings, consents and any other documents, and the taking of any action, deemed by UEC or Concentric, acting reasonably, to be necessary to discharge their respective obligations under applicable Laws in connection with the Merger and the other transactions contemplated hereby.

3.6 Each of UEC and Concentric shall furnish to the other all such information concerning it and its security holders as may be required (and, in the case of its security holders, available to it with reasonable effort) for the effectuation of the actions described in §3.4 and §3.5 and the foregoing provisions of this §3.6, and each covenants that no information furnished by it (to its knowledge in the case of information concerning its security holders) in connection with such actions or otherwise in connection with the consummation of the Merger and the other transactions contemplated by this Agreement will contain any untrue statement of a material fact, or omit to state a material fact required to be stated in any such document or necessary in order to make any information so furnished for use in any such document not misleading in the light of the circumstances in which it is furnished.

**PART 4**  
**REPRESENTATIONS AND WARRANTIES**

D

4.1 Concentric represents and warrants to and in favor of UEC as follows and acknowledges that UEC is relying upon such representations and warranties in connection with the matters contemplated by this Agreement:

(a) **Organization:**

Concentric has been duly incorporated or formed under the applicable Laws of Nevada, is validly subsisting and has full corporate or legal power and authority to carry on the Business, to perform its obligations hereunder and to enter into, own, hold, license and lease its Assets;

Concentric has made all necessary filings under all applicable corporate, securities, and taxation laws or any other laws to which it is subject, and is in good standing in each jurisdiction in which the conduct of its business or the ownership or leasing of its Assets makes that qualification necessary; and

- (iii) Concentric has no minority interest in any other corporation or entity, which minority interest is material in relation to Concentric;

**Capitalization:**

- (i) the authorized capital of Concentric consists of 200,000,000 shares of common stock with a par value of \$0.001. As of the Execution Date of this Agreement there are 11,659,905 Concentric Shares issued and outstanding. Save and except as set out in Section 4.1(b)(i) of the Concentric Disclosure Schedule, there are no options, warrants, conversion privileges or other rights, agreements, arrangements or commitments (pre-emptive, contingent or otherwise) obligating Concentric to issue or sell any shares of Concentric, or ownership interests, securities, or obligations of any kind convertible into or exchangeable for any shares of Concentric or any other Person, nor is there outstanding any stock appreciation rights, phantom equity, or similar rights, agreements, arrangements or commitments based upon the book value, income, or any other attribute of Concentric. All outstanding Concentric Shares have been duly authorized and are validly issued and outstanding as fully paid and non-assessable shares, free of pre-emptive rights; and

save and except as set forth in Section 4.1(b)(ii) of the Concentric Disclosure Schedule, there are no outstanding bonds, debentures or other evidences of indebtedness of Concentric including any which have the right to vote (or that are convertible for or exercisable into securities having the right to vote) with the holders of the Concentric Shares on any matter. There are no outstanding contractual obligations of Concentric to repurchase, redeem or otherwise acquire any of its outstanding securities;



(c) **Authority and No Violation:**

- (i) Concentric has the requisite corporate power and authority to enter into this Agreement and to perform its obligations hereunder. The execution and delivery of this Agreement by Concentric and the consummation by Concentric of the transactions contemplated by this Agreement have been duly authorized by its Board of Directors and no other corporate proceedings on its part are necessary to authorize this Agreement, or the transactions contemplated hereby other than:
  - (A) with respect to finalizing and approving the Proxy Statement and other matters relating thereto; and
  - (B) with respect to the completion of the Merger, the approval of the Concentric Shareholders;
- (ii) this Agreement has been duly executed and delivered by Concentric and constitutes its legal, valid and binding obligation, enforceable against it in accordance with its terms, subject to bankruptcy, insolvency, and other applicable Laws affecting creditors' rights generally, and to general principles of equity;
- (iii) the approval of this Agreement, the execution and delivery by Concentric of this Agreement, and the performance by it of its obligations hereunder, and the completion of the Merger and the transactions contemplated thereby, will not:
  - (A) result in a violation or breach of, require any consent to be obtained under, or give rise to any termination, purchase or sale rights, or payment obligation under any provision of:
    - (I) its articles of incorporation, by-laws or other charter documents, including any unanimous shareholder agreement or any other agreement or understanding relating to ownership of shares or other interests;
    - (II) subject to obtaining any necessary regulatory approvals relating to Concentric, any Laws, judgment, or decree, except to the extent that the violation or breach of, or failure to obtain any consent under, any Laws, judgment or decree would not, individually or in the aggregate, have a Material Adverse Effect on Concentric; or
    - (III) subject to obtaining any necessary regulatory approvals relating to Concentric and the requisite approval of the Concentric Shareholders, and except as would not, individually or in the aggregate, have a Material Adverse Effect on Concentric, or on any Material Contract, agreement, license, franchise, or permit to which it is party or by which it is bound or is subject or is the beneficiary;
  - (B) save and except as set forth in Section 4.1(c)(iii)(B) of the Concentric Disclosure Schedule, give rise to any right of termination or acceleration of indebtedness of Concentric;

- (C) save and except as set forth in Section 4.1(c)(iii)(C) of the Concentric Disclosure Schedule, and except as would not, individually or in the aggregate, have a Material Adverse Effect on Concentric, result in the imposition of any restriction, tax, penalty, Encumbrance, charge, or lien upon any of the Assets, or restrict, hinder, impair, or limit the ability of Concentric to carry on the Business of Concentric as and where it is now being carried on;
- (D) result in any payment (including severance, unemployment compensation, golden parachute, bonus or otherwise) becoming due to any director or employee of Concentric or increase any benefits otherwise payable to any such person or under any Concentric Plans or result in the acceleration of time of payment or vesting of any such benefits, including the time of exercise of stock options; or
- (E) result in the acceleration of time of payment or vesting of any such benefits, including the time of exercise of stock options; and

no consent, approval, order or authorization of, or declaration or filing with, any Governmental Entity is required to be obtained by Concentric, or to its knowledge, any Concentric Shareholder in connection with the execution and delivery of this Agreement or the consummation by Concentric of the transactions contemplated hereby other than (A) any approval of the Concentric Shareholders of the Merger, (B) the filing of the Articles of Merger with the Secretary of State of the State of Nevada and (C) any other consents, approvals, orders, authorizations, declarations or filings of or with a Governmental Entity which, if not obtained, would not, individually or in the aggregate, have a Material Adverse Effect on Concentric;

**No Defaults:** subject to obtaining any necessary regulatory approvals relating to Concentric, Concentric is not in default under, and there exists no event, condition or occurrence which, after notice or lapse of time or both, would constitute such a default under, any contract (including the Material Contracts), agreement, license or franchise to which it is a party which would, if terminated due to such default, cause a Material Adverse Effect;

**Absence of Certain Changes or Events:** save and except for that certain and existing Involuntary Bankruptcy Petition, Concentric has conducted its Business only in the ordinary and regular course of business consistent with past practice and, except as otherwise provided in this Agreement, there has not occurred since the date of the most recent balance sheet forming part of the Concentric Financial Statements:

a Material Adverse Change with respect to Concentric;

any damage, destruction, or loss, whether covered by insurance or not, that could reasonably be expected to have a Material Adverse Effect on Concentric;

any redemption, repurchase or other acquisition of Concentric Shares by Concentric or any declaration, setting aside or payment of any dividend or

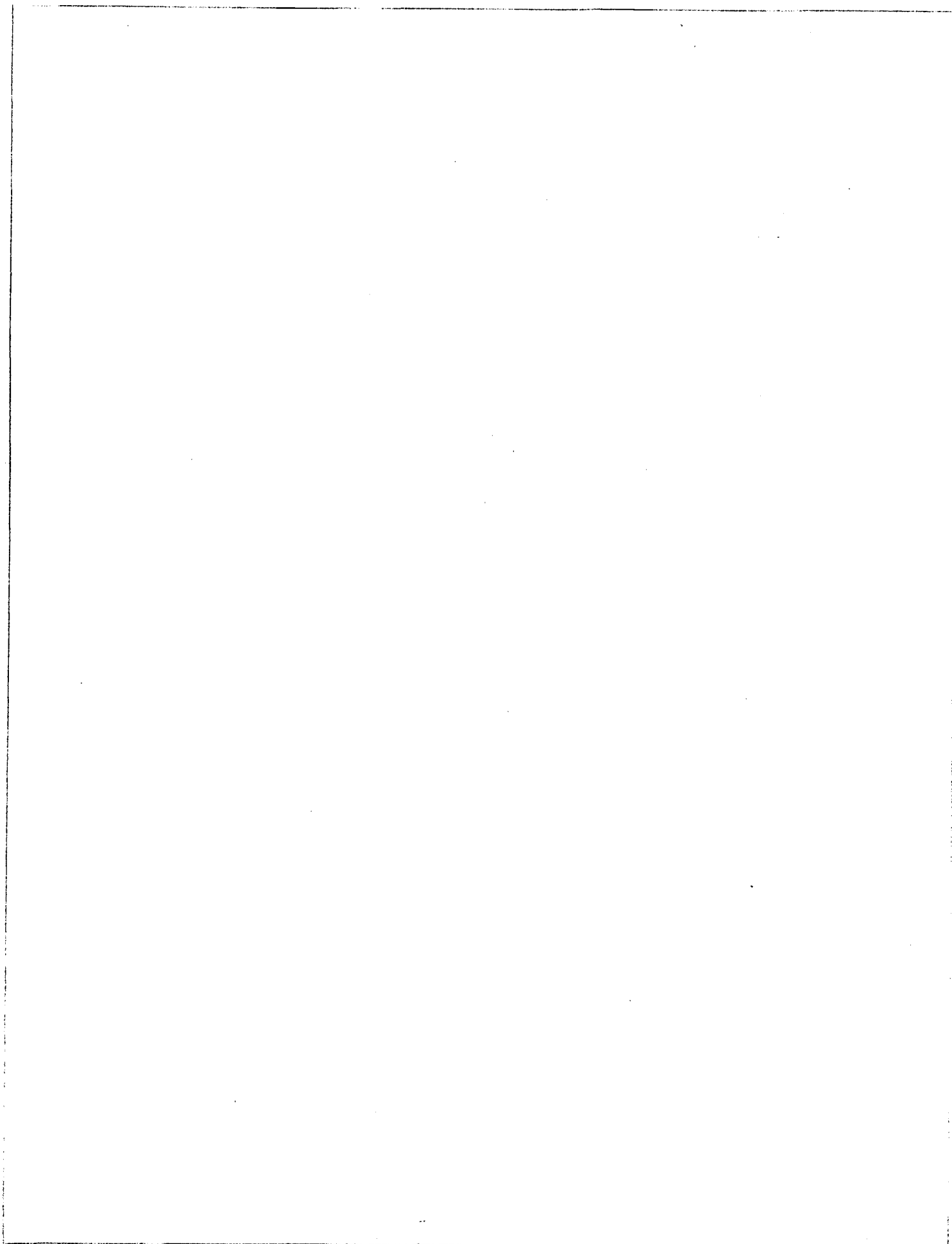

forth in this Agreement materially untrue or incorrect as of the date when made;

- (f) **Absence of Conflict:** to the actual knowledge, information and belief of each of Concentric, the making of this Agreement and the completion of the transactions contemplated hereby and the performance of and compliance with the terms hereof does not and will not:
- (i) conflict with or result in a breach of or violate any of the terms, conditions or provisions of its respective constating documents;
  - (ii) conflict with or result in a breach of or violate any of the terms, conditions or provisions of any law, judgment, order, injunction, decree, regulation or ruling of any court or Governmental Entity, domestic or foreign, to which it is subject, or constitute or result in a default under any agreement, contract or commitment to which it is a party;
  - (iii) give to any party the right of termination, cancellation or acceleration in or with respect to any agreement, contract or commitment to which it is a party;
  - (iv) give to any government or Governmental Entity, or any municipality or any subdivision thereof, including any governmental department, commission, bureau, board or administration agency, any right of termination, cancellation or suspension of, or constitute a breach of or result in a default under, any permit, license, control or authority issued to it which is necessary or desirable in connection with the conduct and operations of its respective business and the ownership or leasing of its respective business assets; or
  - (v) save and except as set forth in Section 4.1(f)(v) of the Concentric Disclosure Schedule, constitute a default by it, or any event which, with the giving of notice or lapse of time or both, might constitute an event of default, under any agreement, contract, indenture or other instrument relating to any indebtedness of it which would give any party to that agreement, contract, indenture or other instrument the right to accelerate the maturity for the payment of any amount payable under that agreement, contract, indenture or other instrument;
- (g) **Employment:**
- (i) except as set forth in Section 4.1(g) of the Concentric Disclosure Schedule, Concentric is not a party to any written or oral policy, agreement, obligation or understanding providing for severance or termination payments to, or any employment agreement with, any director or officer;
  - (ii) no directors, officers or employees of Concentric are now indebted or under obligation to Concentric on any account whatsoever other than in the ordinary and regular course of business of Concentric;
  - (iii) no payments of any kind have been made or authorized by or on behalf of Concentric to or on behalf of any directors, officers, shareholders or

employees of Concentric or under any management agreement with Concentric other than in the ordinary course of business of Concentric;

- (iv) Concentric is not a party to any collective bargaining agreement nor subject to any application for certification or, to the knowledge of Concentric, threatened or apparent union-organizing campaigns for employees not covered under a collective bargaining agreement nor are there any current, pending or, to the knowledge of Concentric, threatened strikes or lockouts at Concentric that would, individually or in the aggregate, have a Material Adverse Effect on Concentric;
  - (v) Concentric is not subject to any claim for wrongful dismissal, constructive dismissal, or any other tort claim, actual or, to the knowledge of Concentric, threatened, or any litigation, actual or, to the knowledge of Concentric, threatened, relating to employment or termination of employment of employees or independent contractors;
  - (vi) Concentric has operated in all material respects in accordance with all applicable Laws with respect to employment and labour, including, but not limited to, employment and labour standards, occupational health and safety, employment equity, pay equity, workers' compensation, human rights and labour relations, and there are no current, pending, or, to the knowledge of Concentric, threatened proceedings before any board or tribunal with respect to any of the above areas;
  - (vii) there are no pensions, profit sharing, group insurance or similar plans or other deferred compensation plans affecting Concentric or any of its directors, officers, or employees; and
  - (viii) Concentric has no consulting or employment agreements, whether written or otherwise, except for those which are set forth in Section 4.1(g) of the Concentric Disclosure Schedule;
- (h) **Financial Statements:** the Concentric Financial Statements have been prepared in accordance with United States generally accepted accounting principles, the requirements of applicable Governmental Entities and applicable securities Laws; and such financial statements present fairly, in all material respects, the financial position and results of operations of Concentric as of the respective dates thereof and for the respective periods covered thereby. There are no liabilities, contingent or otherwise, of Concentric not disclosed or reflected in the Concentric Financial Statements, except those incurred in the ordinary course of business of Concentric since the date of the Concentric Financial Statements;
- (i) **Intellectual Property:**
- (i) Section 4.1(i) of the Concentric Disclosure Schedule contains an accurate and complete description of all of Concentric's Intellectual Property, and the Intellectual Property does not infringe the rights of any other person; and
  - (ii) Concentric does not have and does not use any service mark, tradename or trademark except as disclosed as part of Concentric's Intellectual Property;

a

(I)

(k)

**Environmental:** except for any matters that, individually or in the aggregate, would not have a Material Adverse Effect on Concentric:

all operations of Concentric have been conducted, compliance with all Environmental Laws;

al

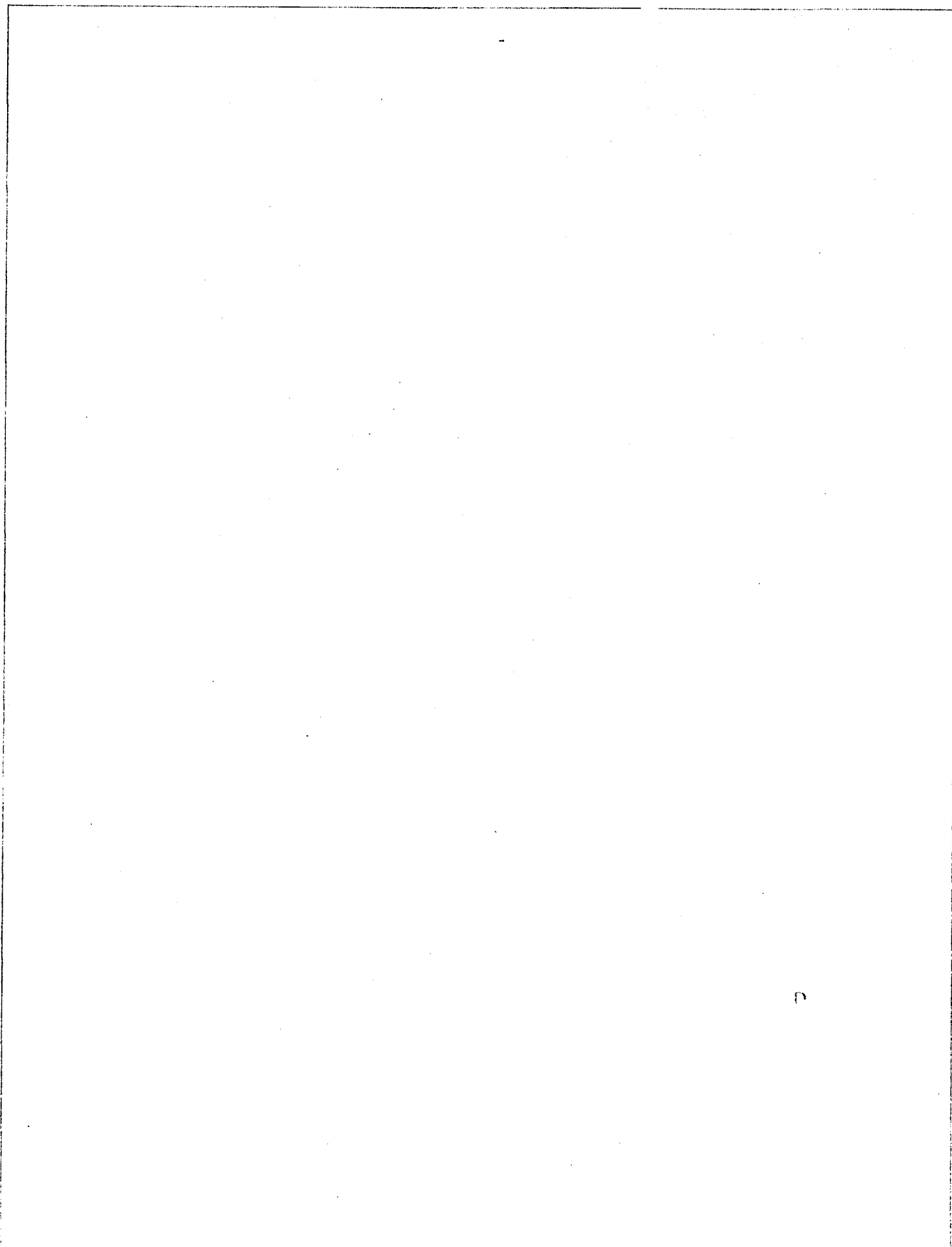



- (iii) Concentric has withheld from each payment made to any of its present or former employees, officers, directors, and any other third party, all amounts required by law and has remitted such withheld amounts within the prescribed time periods to the appropriate Governmental Entity. Concentric has remitted all Taxes and employee contributions payable by it in respect of its employees and has remitted such amounts to the appropriate Governmental Entity within the time required under the applicable legislation. Concentric has charged, collected and remitted within prescribed time periods all Taxes as required under applicable legislation on any sale, supply or delivery whatsoever made by them;

there are no reassessments of the Taxes of Concentric that have been issued and are outstanding. No Governmental Entity has challenged, disputed, or questioned Concentric in respect of Taxes or of any returns, filings or other reports filed under any taxing statute. Concentric is not negotiating any draft assessment or reassessment with any Governmental Entity. Concentric is not aware of any contingent liabilities for Taxes or any grounds for an assessment or reassessment including, without limitation, aggressive treatment of income, expenses, credits or other claims for deduction under any return or notice. Concentric has not received any indication from a Governmental Entity that an assessment or reassessment is proposed in respect of any Taxes regardless of its merits. Concentric has not executed or filed with any Governmental Entity any waiver or agreement extending the time period for assessment, reassessment or collection of any Taxes;

no claim has been made by any Governmental Entity in a jurisdiction where Concentric does not file Tax returns that Concentric is or may be subject to taxation in that jurisdiction;

Concentric is not a party to or bound by any Tax-sharing agreement, Tax indemnity obligation or similar agreement, arrangement or practice with respect to Taxes (including any advance pricing agreement, closing agreement or other agreement relating to Taxes with any Governmental Entity). Concentric has not been a member of an affiliated group of corporations within the meaning of Section 1504 of the Code. Concentric does not have any liability for the Taxes of any other person or entity under Treasury Regulations Section 1.1502-6 (or similar provision of the law of any jurisdiction) as a transferee or successor, by contract or otherwise;

- (vii) no liens for Taxes exist with respect to any of the Assets of Concentric;
- (viii) Concentric is not and never has been a "United States real property holding corporation" within the meaning of Section 897(c)(2) of the Code;
- the non-capital losses of Concentric were incurred by Concentric only in carrying on the Business;
- (ix) Concentric has paid all Taxes imposed on the acquisition of its tangible personal property, and none of its tangible personal property has been transferred at any time on a tax-exempt basis; and

(C)

(p)

(q)

(r)

(s)

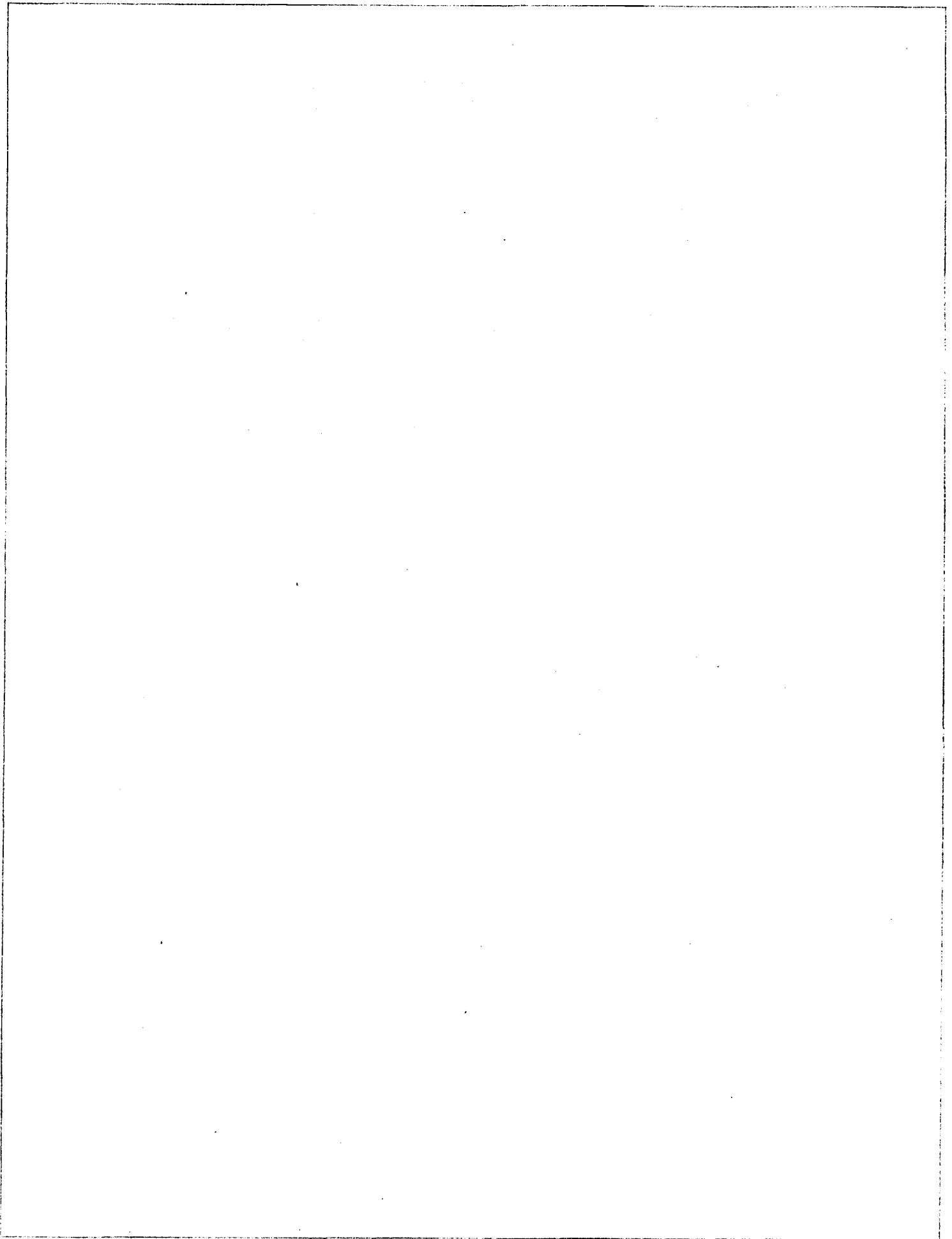

... ..

... .. by

...

...

(vii)

(ix)

applications for exploration and exploitation rights respecting any of the mineral property interests comprising the Mineral Assets;

(xiii) Concentric will also deliver, or cause to be delivered, to UEC as soon as conveniently possible after the Execution Date, however, prior to Closing, a title opinion or opinions respecting the mineral property interests comprising the Mineral Assets, all as addressed to UEC and prepared in accordance with applicable rules and policies, together with such other documentation as UEC may require in order to seek and obtain Regulatory Approval for each of the transactions contemplated by this Agreement; and

(xiv) Concentric is not aware of any fact or circumstance which has not been disclosed to UEC which should be disclosed in order to prevent the representations and warranties contained in this section from being misleading or which would likely affect the decision of UEC to enter into this Agreement;

(z) **Material Contracts:**

(i) save and except as set forth in Section 4.1(z)(i).2 the Concentric Disclosure Schedule, there has not been any breach, default in any term, condition, provision or obligation to be performed under any of the Material Contracts set out in Section 4.1(z)(i).1 of the Concentric Disclosure Schedule, each Material Contract is in good standing, full force and effect, and, with the exception of amendments to the certain Material Contracts described in Section 4.1(z)(i).1 of the Concentric Disclosure Schedule, unamended; and

save and except for those matters which are listed in Section 4.1(z)(i).1 of the Concentric Disclosure Schedule, Concentric does not have any contracts, agreements, undertakings or arrangements, whether oral, written or implied, with employees, lessees, licensees, managers, accountants, suppliers, agents, distributors, directors, officers, lawyers or others which cannot be terminated, without penalty, on no more than one month's notice;

(aa) **Parties to Material Contracts:** each of the Material Contracts contains the entire and only agreement between the parties thereto with respect to the subject matter thereof and identifies therein each person who is a party thereto or is bound thereby, and Concentric has neither received any notice nor is aware that any other party to any Material Contract intends or wishes to cancel such Material Contract nor is there a dispute between Concentric and any other party to any Material Contract;

(ab) **Schedules:** each of the Schedules to the Concentric Disclosure Schedule contains all material information for each particular Schedule listed therein and there are no omissions of material information by Concentric in the Concentric Disclosure Schedule;

(ac) **No Other Options or Agreements to Acquire the Business:** there is no written, oral, or implied agreement, option, understanding or commitment, or any right or privilege capable of becoming any of the same, for the purchase from Concentric of the Business or any of the Assets, other than purchase orders or requests

accepted by it in the usual and ordinary course of the operation of the Business;  
and

- (ad) **No Other Facts or Circumstances:** Concentric is not aware of any fact or circumstance which has not been disclosed to UEC which should be disclosed in order to prevent the representations contained in this section from being misleading or which would likely affect the decision of UEC to enter into this Agreement.

#### Representations and Warranties of UEC

4.2 UEC represents and warrants to and in favor of Concentric as follows and acknowledges that Concentric is relying upon such representations and warranties in connection with the matters contemplated by this Agreement:

- (a) **Organization of UEC:**
- (i) UEC has been duly incorporated or formed under the applicable Laws of Nevada, is validly subsisting and has full corporate or legal power and authority to carry on the Business, to perform its obligations hereunder and to enter into, own, hold, license and lease its Assets; and
  - (ii) UEC has made all necessary filings under all applicable corporate, securities, and taxation laws or any other laws to which it is subject, and is in good standing in each jurisdiction in which the conduct of its business or the ownership or leasing of its Assets makes that qualification necessary;
- (b) **Capitalization of UEC:** the authorized capital of UEC consists of 750,000,000 shares of common stock with a par value of \$0.001. All outstanding UEC Shares have been duly authorized and are validly issued and outstanding as fully paid and non-assessable shares, free of pre-emptive rights;
- (c) **Authority and No Violation:**
- (i) UEC has the requisite corporate power and authority to enter into this Agreement and to perform its obligations hereunder. The execution and delivery of this Agreement by UEC and the consummation by UEC of the transactions contemplated by this Agreement have been duly authorized by its Board of Directors and no other corporate proceedings on its part are necessary to authorize this Agreement or the transactions contemplated hereby other than with respect to the finalizing and approving the Registration Statement and other matters related thereto;
  - (ii) this Agreement has been duly executed and delivered by UEC and constitutes its legal, valid and binding obligation, enforceable against it in accordance with its terms, subject to bankruptcy, insolvency and other applicable Laws affecting creditors' rights generally, and to general principles of equity;
  - (iii) the approval of this Agreement, the execution and delivery by UEC of this Agreement and the performance by it of its obligations hereunder and the

completion of the Merger and the transactions contemplated thereby will not:

- (A) result in a violation or breach of, require any consent to be obtained under, or give rise to any termination, purchase or sale rights, or payment obligation under any provision of:
  - (I) its articles of incorporation, by-laws or other charter documents, including any unanimous shareholder agreement or any other agreement or understanding relating to ownership of shares or other interests or to corporate governance with any party holding an ownership interest in UEC;
  - (II) subject to obtaining any necessary Regulatory Approvals relating to UEC, any Laws, judgment or decree, except to the extent that the violation or breach of, or failure to obtain any consent under, any Laws, judgment or decree would not, individually or in the aggregate, have a Material Adverse Effect on UEC; or
  - (III) subject to obtaining any necessary Regulatory Approvals relating to UEC, and except as would not, individually or in the aggregate, have a Material Adverse Effect on UEC, any Material Contract, agreement, license, franchise, or permit to which it is party or by which it is bound or is subject or is the beneficiary;
- (B) give rise to any right of termination or acceleration of indebtedness of UEC, or cause such indebtedness to come due before its stated maturity or cause any available credit of UEC to cease to be available;
- (C) except as would not, individually or in the aggregate, have a Material Adverse Effect on UEC, result in the imposition of any encumbrance, charge or lien upon any of its assets, or restrict, hinder, impair, or limit its ability to carry on its business as and where it is now being carried on; or
- (D) result in any payment (including severance, unemployment compensation, golden parachute, bonus or otherwise) becoming due to any director or employee of UEC or increase any benefits otherwise payable under any UEC plans or result in the acceleration of time of payment or vesting of any such benefits, including the time of exercise of stock options.

No consent, approval, order or authorization of, or declaration or filing with, any Governmental Entity is required to be obtained by UEC in connection with the execution and delivery of this Agreement or the consummation by UEC of the transactions contemplated hereby or thereby other than any consents, approvals, orders, authorizations, declarations or filings of or with a Governmental Entity which, if not obtained, would not, individually or in the aggregate, have a Material Adverse Effect on UEC;

- (d) **No Defaults:** subject to obtaining any necessary Regulatory Approvals relating to UEC, UEC is not in default under, and there exists no event, condition or occurrence which, after notice or lapse of time or both, would constitute such a default under, any contract (including the Material Contracts), agreement, license or franchise to which it is a party which would, if terminated due to such default, cause a Material Adverse Effect;
- (e) **Absence of Certain Changes or Events:** since the date of the most recent balance sheet forming part of the UEC Financial Statements, UEC has conducted its Business only in the ordinary and regular course of business consistent with practice and, except as otherwise provided in this Agreement, there has not occurred:
- (i) a Material Adverse Change with respect to UEC;
  - (ii) any damage, destruction, or loss, whether covered by insurance or not, that could reasonably be expected to have a Material Adverse Effect on UEC;
  - (iii) any redemption, repurchase or other acquisition of UEC Shares by UEC or any declaration, setting aside or payment of any dividend or other distribution (whether in cash, stock or property) with respect to UEC Shares;
  - (iv) any material increase in or modification of the compensation payable or to become payable by it to any of its directors or officers, or any grant to any such director or officer of any increase in severance or termination pay;
  - (v) any increase in or modification of any bonus, pension, insurance or benefit arrangement (including the granting of stock options, restricted stock awards or stock appreciation rights) made to, for or with any of its directors or officers;
  - (vi) any acquisition or sale of its property or Assets to a Person not dealing at arm's length;
  - (vii) any entering into, amendment of, relinquishment, termination or non-renewal by it of any Material Contract, agreement, license, franchise, lease transaction, commitment or other right or obligation, other than in the ordinary and regular course of business consistent with past practice;
  - (viii) an act whereby UEC has engaged or entered into any transaction or made any disbursement or assumed or incurred any liability or obligation or made any commitment to make any expenditure which might materially and adversely affect any of the Assets or the organization, operations, affairs, Business, properties, prospects or financial condition or position of UEC;
  - (ix) any resolution to approve a combination or reclassification of any of its outstanding shares;
  - (x) an act whereby UEC has purchased or agreed to purchase, or leased or agreed to lease, or acquired or agreed to acquire, any property or asset, other than as required in the usual and ordinary course of the operation of the Business;



- (xi) an act whereby UEC has sold, transferred, disposed of, mortgaged, pledged, charged, or leased any Asset or property, other than as required in the usual and ordinary course of the operation of the Business;
- (xii) any change in its accounting methods, principles or practices; or
- (xiii) any agreement or arrangement to take any action which, if taken prior to the Execution Date, would have made any representation or warranty set forth in this Agreement materially untrue or incorrect as of the date when made;

(f) **Employment:**

- (i) except as set forth in the UEC SEC Filings, UEC is not a party to any written or oral policy, agreement, obligation or understanding providing for severance or termination payments to, or any employment agreement with, any director or officer;
- (ii) UEC is not a party to any collective bargaining agreement nor subject to any application for certification or, to the knowledge of UEC, threatened or apparent union-organizing campaigns for employees not covered under a collective bargaining agreement nor are there any current, pending or, to the knowledge of UEC, threatened strikes or lockouts at UEC that would, individually or in the aggregate, have a Material Adverse Effect on UEC;
- (iii) except as set forth in the UEC SEC Filings, UEC is not subject to any claim for wrongful dismissal, constructive dismissal, or any other tort claim, actual or, to the knowledge of UEC, threatened, or any litigation, actual or, to the knowledge of UEC, threatened, relating to employment or termination of employment of employees or independent contractors; and
- (iv) UEC has operated in all material respects in accordance with all applicable laws with respect to employment and labour and including, without limitation, employment and labour standards, occupational health and safety, employment equity, pay equity, workers' compensation, human rights and labour relations, and there are no current, pending, or, to the knowledge of UEC, threatened proceedings before any board or tribunal with respect to any of the above areas;

(g) **Financial Statements:** the UEC Financial Statements have been prepared in accordance with United States generally accepted accounting principles, the requirements of applicable Governmental Entities and applicable securities Laws; and such financial statements present fairly, in all material respects, the consolidated financial position and results of operations of UEC as of the respective dates thereof and for the respective periods covered thereby;

(h) **Books and Records:** the books, records and accounts of UEC, in all material respects:

- (i) have been maintained in accordance with good business practices on a basis consistent with prior years;
- (ii) are stated in reasonable detail and accurately and fairly reflect the transactions and dispositions of the Assets of UEC; and

- (iii) accurately and fairly reflect the basis for the UEC Financial Statements. UEC has devised and maintains a system of internal accounting controls sufficient to provide reasonable assurances that:
  - (A) transactions are executed in accordance with management's general or specific authorization; and
  - (B) transactions are recorded as necessary:
    - (I) to permit preparation of financial statements in conformity with United States generally accepted accounting principles or any other criteria applicable to such statements; and
    - (II) to maintain accountability for Assets;
- (i) **Reports:** to the best of its knowledge after due inquiry, UEC has filed with or furnished to the Commission true and complete copies of all forms, reports, schedules, statements and other documents required to be filed or furnished by it, and such documents, at the time filed or furnished:
  - (i) did not contain any misrepresentation (as defined in the applicable securities Laws); and
  - (ii) complied in all material respects with the requirements of applicable securities Laws.
- (j) **UEC Shares:** UEC Shares to be issued pursuant to the Merger will be duly and validly issued by UEC on their respective dates of issue as fully paid and non-assessable shares;
- (k) **Compliance with Laws:** except as set forth in the UEC SEC Filings, UEC has complied with and is not in violation of any applicable Laws, orders, judgments and decrees other than non-compliance or violations which would not, individually or in the aggregate, have a Material Adverse Effect on UEC. Without limiting the generality of the foregoing, all securities of UEC (including all options, rights or other convertible or exchangeable securities) have been issued in compliance in all material respects with all applicable securities Laws and all securities to be issued upon the exercise of any such options, rights and other convertible or exchangeable securities will be issued in compliance with all applicable securities Laws;
- (l) **Litigation, Etc.:** except as set forth in the UEC SEC Filings, there is no claim, action, proceeding, or investigation pending or, to the knowledge of UEC, threatened against UEC before any court or Governmental Entity. Neither UEC or its assets or properties is subject to any outstanding judgment, order, writ, injunction, or decree;
- (m) **No Defaults:** subject to obtaining any necessary Regulatory Approvals relating to UEC, UEC is not in default under, and there exists no event, condition or occurrence which, after notice or lapse of time or both, would constitute such a default under, any contract (including the Material Contracts), agreement, license or franchise to which it is a party which would, if terminated due to such default, cause a Material Adverse Effect;

- (n) **Environmental:** except as set forth in the UEC SEC Filings, and except for any matters that, individually or in the aggregate, would not have a Material Adverse Effect on UEC:
- (i) all operations of UEC have been conducted, and are now in compliance with all Environmental Laws;
  - (ii) UEC is in possession of, and in compliance with, all permits, authorizations, certificates, registrations, approvals and consents necessary under Environmental Laws to own, lease and operate its properties and to conduct its business as it is now being conducted or as proposed to be conducted (collectively the "**Environmental Permits**"); and
  - (iii) UEC is not aware of, or is subject to:
    - (A) any Environmental Laws which require or may require any work, repairs, construction, change in business practices or operations, or expenditures, including capital expenditures for facility upgrades, environmental investigation and remediation expenditures, or any other such expenditures;
    - (B) any written demand or written notice with respect to the breach of or liability under any Environmental Laws applicable to UEC, including any regulations respecting the use, storage, treatment, transportation or disposition (including disposal or arranging for disposal) of Hazardous Substances;
    - (C) any written demand or written notice with respect to liability, by contract or operation of applicable Laws, under Environmental Laws applicable to UEC or any current or former subsidiary or any of its predecessor entities, divisions or any formerly owned, leased or operated properties or Assets of the foregoing, including liability with respect to the presence, release or discharge of Hazardous Substances; or
    - (D) any changes in the terms or conditions of any Environmental Permits or any renewal, modification, revocation, re-issuance, alteration, transfer or amendment of such Environmental Permits, or any review by, or approval of, any Governmental Entity of such Environmental Permits that are required in connection with the execution or delivery of this Agreement, the consummation of the transactions contemplated hereby or the continuation of the Business following such consummation;
  - (iv) UEC has not conducted the Business or used any of the Assets or permitted them to be conducted or used, to generate, manufacture, refine, treat, transport, store, handle, dispose of, transfer, produce or process Hazardous Substances, except in compliance with all applicable judgments, decrees, orders, injunctions, rules, statutes and regulations of all courts, arbitrators or Governmental Entities, including all environmental, health and safety statutes and regulations and, to the best of UEC's knowledge, neither has any lessee or prior owner of any of the Assets or any other Person;

- (v) UEC, the Business and the Assets and the uses to which its assets have been put and the state of maintenance and repair thereof comply in all material respects with all applicable Laws, judgments, decrees, orders, injunctions, rules and regulations of all Governmental Entities, courts or arbitrators, including all environmental, health and safety statutes and regulations and fire and building codes and standards;
  - (vi) UEC has not received any notices of any contravention of, or demands or requests for, repairs or other remedial work with respect to any of its assets under any statutes, bylaws, ordinances, rules or regulations of any Governmental Entity or arising from the use of any of its assets, or the occupation or use of any premises owned, leased or utilized by UEC or relating to the location, size, configuration, state of repairs, design or construction of, or defects in any of these premises;
  - (vii) UEC is not subject to any judicial or administrative proceeding alleging the violation of any applicable Environmental Laws, health or safety laws or other statutes and regulations, judgments, decrees, orders, injunctions, or rules;
  - (viii) UEC is not the subject of investigation by any Governmental Entity evaluating whether any remedial action is needed to respond to a release of any Hazardous Substance into the environment nor has any Hazardous Substance been released into the environment, or disposed of, at, on, or near any property used or previously used by UEC as a result of the conduct of the Business or otherwise, except as permitted by the laws or regulations enforced at the relevant time and UEC does not have any contingent liability in connection with the release of any Hazardous Substance or contaminant or other substance into the environment; and
  - (ix) UEC has not filed any notice under any applicable Environmental Laws, health or safety laws, other statutes or regulations, judgments, decrees, orders or injunctions, indicating past or present treatment, storage, or disposal of a Hazardous Substance or constituent, or other substance into the environment, and, to the best of the knowledge of UEC, there are no orders or directions relating to environmental matters requiring any work, repairs or capital expenditures with respect to the Assets or Business;
- (o) **Tax Matters:** in respect of Taxes:
- (i) UEC has prepared and filed on time with all appropriate Governmental Entities all returns and other documents that it is required to file in respect of any Taxes, or in respect of any other provision in any domestic or foreign federal, provincial, municipal, state, territorial or other taxing statute for all fiscal periods ending prior to the Execution Date, and that all such returns and other documents are correct and complete in all material respects;
  - (ii) UEC has paid in full and when due all Taxes required to be paid by it on or prior to the Execution Date, and will have paid all such Taxes as of the Effective Date;
  - (iii) UEC has withheld from each payment made to any of its present or former employees, officers, directors, and any other third party, all amounts

required by law and has remitted such withheld amounts within the prescribed time periods to the appropriate Governmental Entity. UEC has remitted all Taxes and employee contributions payable by it in respect of its employees and has remitted such amounts to the appropriate Governmental Entity within the time required under the applicable legislation. UEC has charged, collected and remitted within prescribed time periods all Taxes as required under applicable legislation on any sale, supply or delivery whatsoever made by them;

- (iv) there are no reassessments of the Taxes of UEC that have been issued and are outstanding. No Governmental Entity has challenged, disputed, or questioned UEC in respect of Taxes or of any returns, filings or other reports filed under any taxing statute. UEC is not negotiating any draft assessment or reassessment with any Governmental Entity. UEC is not aware of any contingent liabilities for Taxes or any grounds for an assessment or reassessment including, without limitation, aggressive treatment of income, expenses, credits or other claims for deduction under any return or notice. UEC has not received any indication from a Governmental Entity that an assessment or reassessment is proposed in respect of any Taxes regardless of its merits. UEC has not executed or filed with any Governmental Entity any waiver or agreement extending the time period for assessment, reassessment or collection of any Taxes;
- (v) no claim has been made by any Governmental Entity in a jurisdiction where UEC does not file Tax returns that UEC is or may be subject to taxation in that jurisdiction;
- (vi) UEC is not a party to or bound by any Tax-sharing agreement, Tax indemnity obligation or similar agreement, arrangement or practice with respect to Taxes (including any advance pricing agreement, closing agreement or other agreement relating to Taxes with any Governmental Entity). UEC has not been a member of an affiliated group of corporations within the meaning of Section 1504 of the Code. UEC does not have any liability for the Taxes of any other person or entity under Treasury Regulations Section 1.1502-6 (or similar provision of the law of any jurisdiction) as a transferee or successor, by contract or otherwise;
- (vii) no liens for Taxes exist with respect to any of the Assets of UEC;
- (viii) UEC is not and never has been a "United States real property holding corporation" within the meaning of Section 897(c)(2) of the Code;
- (ix) the non-capital losses of UEC were incurred by UEC only in carrying on the Business;
- (x) UEC has paid all Taxes imposed on the acquisition of its tangible personal property, and none of its tangible personal property has been transferred at any time on a tax-exempt basis; and
- (xii) except as set forth in the UEC SEC Filings, UEC has not, prior to the Execution Date:
  - (A) discontinued carrying on any business in respect of which non-capital losses were incurred;

- (B) acquired or had the use of any property from a person with whom it was not dealing at arm's length;
- (C) disposed of anything to a person with whom it was not dealing at arm's length for proceeds less than or greater than the fair market value thereof; or
- (D) paid any dividends or made any distributions to its shareholders with respect to any of its shares or other ownership interests herein; nor does it have any plans to do any of the foregoing in the future.

### **Survival**

4.3 For greater certainty, the representations and warranties of UEC and Concentric contained herein shall survive the execution and delivery of this Agreement and, notwithstanding the completion of the Merger, continue in full force and effect for the benefit of Concentric and UEC, respectively, for a period of two years from Closing. Any investigation by a Party hereto and its advisors shall not mitigate, diminish or affect the representations and warranties of the other Party to this Agreement.

## **PART 5** **COVENANTS**

### **Covenants of Concentric**

5.1 During the Pre-Effective Date Period Concentric will, subject to the fact that a transaction involving its Business is contemplated hereby, continue to carry on the Business of Concentric in a manner consistent with prior practice, working to preserve the attendant goodwill and good standing of such entities and their Assets and to contribute to retention of that goodwill to and after the Execution Date. The following provisions of this Part 5 are intended to be in furtherance of this general commitment.

5.2 Commencing immediately, and for the duration of this Agreement, Concentric covenants that it will not, nor will it permit its directors, officers, employees, agents, affiliates, associates or any of its employees, officers or directors to solicit, discuss, encourage, procure, negotiate or accept any offers to finance or purchase Concentric, or any component thereof to form any type of business combination and including, without limiting the generality of the foregoing, a merger, amalgamation, share exchange, takeover, joint venture or pooling of interests. Notwithstanding the foregoing or anything to the contrary in this Agreement, if prior to the approval of this Agreement by the stockholders of Concentric the Board of Directors of Concentric determines, in good faith, after consultation with outside counsel, that it is necessary to do so in order to avoid breaching its fiduciary duties to the stockholders of Concentric under applicable Nevada law, Concentric may, in response to an unsolicited Takeover Proposal of the sort referred to in §5.2(b) that the Board of Directors of Concentric determines, in good faith, does or is reasonably likely to involve consideration to the stockholders of Concentric that is superior to the consideration provided for in the Merger, (i) furnish information with respect to Concentric pursuant to a customary confidentiality agreement to any Person making such proposal and (ii) participate in negotiations regarding such proposal.

- (a) Neither the Board of Directors of Concentric nor any committee thereof shall: (i) withdraw or modify, or propose to withdraw or modify, the approval or

recommendation by such Board of Directors or such committee of this Agreement or the Merger; (ii) approve or recommend, or propose to approve or recommend, any transaction described in the first sentence of §5.2; or (iii) cancel or fail to call or hold the Concentric Meeting or remove this Agreement and the Merger from consideration at such meeting prior to completion of the vote of the stockholders of Concentric on this Agreement and the Merger; except in each such case (A) in connection with an unsolicited Takeover Proposal that the Board of Directors of Concentric determines in good faith constitutes a Superior Proposal and (B) if the Board of Directors of Concentric determines in good faith, after consultation with outside counsel, that it is necessary to do so in order to avoid breaching its fiduciary duties to the stockholders of Concentric under applicable Nevada law.

- (b) As used in this Agreement: "**Superior Proposal**" means a bona fide unsolicited "**Alternative Transaction**" (as defined below) for Concentric that: (i) is not conditional on obtaining financing; and (ii) in respect of which the Board of Directors of Concentric have determined in good faith, after consultation with, and receiving advice (which may include a written opinion) from, as appropriate, its financial, legal and other advisors that such Alternative Transaction would, if consummated in accordance with its terms, reasonably likely result in a transaction more favourable to Concentric's shareholders from a financial point of view than the proposed transaction with UEC. The term "**Alternative Transaction**" means any of the following transactions between Concentric or any of its affiliates and any person other than UEC: (i) the acquisition or purchase of any capital stock or other voting security, any security convertible into or exercisable or exchangeable for any capital stock or other voting security of Concentric or any subsidiary of Concentric or all or a substantial portion of the assets of Concentric or any subsidiary of Concentric; (ii) a merger, recapitalization, reorganization, joint venture or other business combination involving Concentric or any subsidiary of Concentric; or (iii) any other extraordinary business transaction involving or otherwise relating to Concentric or any subsidiary of Concentric.
- (c) Should the Merger fail to complete due to any breach by Concentric of §5.2 or as a result of Concentric's acceptance (in any manner) of a Superior Proposal, Concentric shall pay to UEC a break fee of U.S. \$3,000,000.00 within two business days of any such event (the "**Break-fee**"). In this regard the Parties acknowledge and agree that, in consideration of each of (i) the substantive time, effort and expense being expended by UEC to both complete the within Merger and reorganize and secure the Business interests of Concentric consequent thereon, (ii) the requirement of UEC, as a condition precedent to the completion of the Merger, to negotiate and conclude the acquisition from Global Uranium Corp. of its contractual interests in the Mineral Assets, (iii) the prior loan by UEC to Concentric of U.S. \$300,000 and the risk associated with the same prior to the execution and completion of this Agreement and the Merger and (iv) the numerous creditors of Concentric which UEC has had cause to negotiate with prior to the execution of this Agreement, the Break-fee is fair and reasonable from a financial point of view and that the Board of Directors of Concentric has received appropriate financial and legal advice advising them of the same.

5.3 Concentric covenants and agrees that, until the Effective Date or the earlier termination of this Agreement in accordance with Part 7, except (i) with the consent of UEC to any deviation therefrom, which consent may be withheld by UEC in its sole discretion; or (ii) with respect to any matter contemplated by this Agreement or the Merger, Concentric will:

- (a) carry on its Business in, and only in, the ordinary and regular course in substantially the same manner as heretofore conducted and, to the extent consistent with such Business, use all reasonable efforts to preserve intact its present business organization and keep available the services of its present officers and employees and others having business dealings with it to the end that its goodwill and Business shall be maintained;
- (b) except as set out in this Agreement, not commence to undertake a substantial expansion of its Business or an expansion that is out of the ordinary and regular course of Business consistent with prior practice in light of current market and economic conditions;
- (c) not split, combine or reclassify any of the outstanding shares of Concentric nor declare, set aside or pay any dividends on or make any other distributions on or in respect of the outstanding shares of Concentric;
- (d) not amend the articles of incorporation or by-laws of Concentric;
- (e) not sell, pledge, encumber, allot, reserve, set aside or issue, authorize or propose the sale, pledge, encumbrance, allotment, reservation, setting aside or issuance of, or purchase or redeem or propose the purchase or redemption of, any shares in its capital stock or any class of securities convertible or exchangeable into, or rights, warrants or options to acquire, any such shares or other convertible or exchangeable securities;
- (f) not reorganize, amalgamate or merge Concentric with any other Person, nor acquire or agree to acquire by amalgamating, merging or consolidating with, purchasing substantially all of the assets of or otherwise, any business of any corporation, partnership, association or other business organization or division thereof, which acquisition would be material to its business or financial condition;
- (g) not sell, pledge, encumber, lease or otherwise dispose of any material Assets;
- (h) not guarantee the payment of material indebtedness or incur material indebtedness for money borrowed or issue or sell any debt securities nor shall Concentric increase the level of any current indebtedness owed by it;
- (i) use commercially reasonable efforts to comply promptly with all requirements which applicable Laws may impose on Concentric with respect to the transactions contemplated hereby and by the Merger;
- (j) not:
  - (i) other than in the usual, ordinary and regular course of Business and consistent with past practice or pursuant to existing employment, pension, supplemental pension, termination, compensation arrangements or policies, enter into or materially modify any employment, severance, collective bargaining or similar agreements, policies or arrangements with, or grant any material bonuses, salary increases, stock options, pension or



supplemental pension benefits, profit sharing, retirement allowances, deferred compensation, incentive compensation, severance or termination pay to, or make any loan to, any officers or directors of it; or

- (ii) other than in the usual, ordinary and regular course of Business and consistent with past practice or pursuant to existing employment, pension, supplemental pension, termination, compensation arrangements or policies, in the case of employees who are not officers or directors, take any action with respect to the entering into or modifying of any material employment, severance, collective bargaining or similar agreements, policies or arrangements or with respect to the grant of any material bonuses, salary increases, stock options, pension or supplemental pension benefits, profit sharing, retirement allowances, deferred compensation, incentive compensation, severance or termination pay or any other form of compensation or profit sharing or with respect to any increase of benefits payable;
- (k) not, except in the usual, ordinary and regular course of Business and consistent with past practice:
  - (i) satisfy or settle any claims or liabilities prior to the same being due, except such as have been reserved in Section 5.3(k)(i) of the Concentric Disclosure Schedule, which are, individually or in the aggregate, material;
  - (ii) grant any waiver, exercise any option or relinquish any contractual rights which are, individually or in the aggregate, material; or
  - (iii) enter into any interest rate, currency or commodity swaps, hedges or other similar financial instruments;
- (l) not settle or compromise any claim brought by any present, former or purported Concentric Shareholder in connection with the transactions contemplated by this Agreement or the Merger prior to the Effective Date;
- (m) except in the usual, ordinary and regular course of Business and consistent with past practice or as required by applicable Laws, not enter into or modify in any material respect any contract, agreement, commitment or arrangement, including Material Contracts, which new contract or series of related new contracts or modification to an existing contract or series of related existing contracts which would have a Material Adverse Effect on Concentric;
- (n) incur or commit to capital expenditures prior to the Effective Date only in the ordinary course consistent with past practice and not, in any event, exceeding U.S. \$10,000.00, individually or in the aggregate (other than its agreements with its legal counsel and, if applicable, its fairness opinion consultants);
- (o) not make any changes to existing accounting practices relating to Concentric except as required by Law or required by generally accepted accounting principles or make any material tax election inconsistent with past practice;
- (p) promptly advise UEC orally and, if then requested, in writing:
  - (i) of any event occurring subsequent to the Execution Date of this Agreement that would render any representation or warranty of Concentric

contained in this Agreement (except any such representation or warranty which speaks as of a date prior to the occurrence of such event), if made on or as of the date of such event or the Effective Date, untrue or inaccurate in any material respect;

- (ii) of any Material Adverse Change in respect of Concentric; and
  - (iii) of any material breach by Concentric of any covenant or agreement contained in this Agreement; and
- (q) Concentric shall perform all obligations required or desirable to be performed by Concentric under this Agreement, co-operate with UEC in connection therewith, and do all such other acts and things as may be necessary or desirable in order to consummate and make effective, as soon as reasonably practicable, the transactions contemplated in this Agreement and, without limiting the generality of the foregoing, Concentric shall:
- (i) use commercially reasonable efforts to obtain the approval of Concentric Shareholders to the Merger, subject, however, to the exercise by the Board of Directors of Concentric of its fiduciary duties as provided herein;
  - (ii) cooperate with UEC in order to facilitate the due diligence investigations conducted by UEC with respect to the Merger and the transactions contemplated herein;
  - (iii) apply for and use commercially reasonable efforts to obtain any necessary Regulatory Approvals relating to Concentric and, in doing so, to keep UEC reasonably informed as to the status of the proceedings related to obtaining any necessary Regulatory Approvals and including, without limitation, providing UEC with copies of all related applications and notifications, in draft form, in order for UEC to provide its reasonable comments;
  - (iv) defend all lawsuits or other legal, regulatory or other proceedings challenging or affecting this Agreement or the consummation of the transactions contemplated hereby;
  - (v) use commercially reasonable efforts to have lifted or rescinded any injunction or restraining order or other order relating to Concentric which may adversely affect the ability of the parties to consummate the transactions contemplated hereby;
  - (vi) effect all necessary registrations, filings and submissions of information required by Governmental Entities from Concentric;
  - (vii) use commercially reasonable efforts to ensure that all required Lock-Up Agreements are executed with such Concentric Shareholders who hold not less than 50.1% of all Concentric Shares on a non-fully diluted basis as soon as reasonably practicable after the Execution Date;
  - (viii) use commercially reasonable efforts to ensure that a satisfactory Kettell Arrangement is arrived at as soon as reasonably practicable after the Execution Date; and

- (ix) use commercially reasonable efforts to obtain all necessary waivers, consents and approvals required to be obtained by Concentric from other parties to loan agreements, leases or other contracts including Material Contracts.

### Covenants of UEC

5.4 UEC hereby covenants and agrees:

- (a) to perform all obligations required or desirable to be performed by it under this Agreement, to co-operate with Concentric in connection therewith, and to do all such other acts and things as may be necessary or desirable in order to consummate and make effective, as soon as reasonably practicable, the transactions contemplated by this Agreement and, without limiting the generality of the foregoing, to:
  - (i) use commercially reasonable efforts to have the Registration Statement filed with the Commission and declared effective;
  - (ii) cooperate with Concentric in order to facilitate the due diligence investigations conducted by Concentric with respect to the Merger and the transactions contemplated herein;
  - (iii) defend all lawsuits or other legal, regulatory or other proceedings challenging or affecting this Agreement or the consummation of the transactions contemplated hereby;
  - (iv) apply for and use commercially reasonable efforts to obtain all necessary Regulatory Approvals relating to UEC and, in doing so, to keep Concentric reasonably informed as to the status of the material proceedings related to obtaining any necessary Regulatory Approvals and including, without limitation, providing Concentric with copies of all related applications and notifications, in draft form, in order for Concentric to provide its reasonable comments;
  - (v) effect all necessary registrations, filings and submissions of information required by Governmental Entities from UEC; and
  - (vi) cause UEC to reserve a sufficient number of UEC Shares for issuance in connection with the Merger upon the completion of the Merger;
- (b) use commercially reasonable efforts to comply promptly with all requirements which applicable Laws may impose on UEC with respect to the transactions contemplated hereby and by the Merger;
- (c) until the Effective Date or the earlier termination of this Agreement in accordance with Part 7, except (i) with the consent of Concentric to any deviation therefrom, which shall not be unreasonably withheld, or (ii) with respect to any matter otherwise provided for by this Agreement or the Merger, UEC will:
  - (i) carry on its Business in, and only in, the ordinary and regular course in substantially the same manner as heretofore conducted and, to the extent consistent with such Business, use all reasonable efforts to preserve intact

its present Business organization and keep available the services of its present officers and employees and others having business dealings with it to the end that its goodwill and Business shall be maintained;

- (ii) except as set out in this Agreement, not commence to undertake a substantial expansion of its Business or an expansion that is out of the ordinary and regular course of Business consistent with prior practice in light of current market and economic conditions;
- (iii) not split, combine or reclassify any of its outstanding shares nor declare, set aside or pay any dividends on or make any other distributions on or in respect of its outstanding shares;
- (iv) not amend its articles of incorporation or bylaws, as applicable;
- (v) not reorganize, amalgamate or merge UEC with any other Person, nor acquire by amalgamating, merging or consolidating with, purchasing a majority of the voting securities or substantially all of the assets of or otherwise any business of any corporation, partnership, association or other business organization or division thereof, which acquisition would be material to its business or financial condition on a consolidated basis;
- (vi) not sell, pledge, encumber, lease or otherwise dispose of any material Assets;
- (vii) not:
  - (A) other than in the usual, ordinary and regular course of Business and consistent with past practice or pursuant to existing employment, pension, supplemental pension, termination, compensation arrangements or policies, enter into or materially modify any employment, severance, collective bargaining or similar agreements, policies or arrangements with, or grant any material bonuses, salary increases, stock options, pension or supplemental pension benefits, profit sharing, retirement allowances, deferred compensation, incentive compensation, severance or termination pay to, or make any loan to, any officers or directors of it; or
  - (B) other than in the usual, ordinary and regular course of Business and consistent with past practice or pursuant to existing employment, pension, supplemental pension, termination, compensation arrangements or policies, in the case of employees who are not officers or directors, take any action with respect to the entering into or modifying of any material employment, severance, collective bargaining or similar agreements, policies or arrangements or with respect to the grant of any material bonuses, salary increases, stock options, pension or supplemental pension benefits, profit sharing, retirement allowances, deferred compensation, incentive compensation, severance or termination pay or any other form of compensation or profit sharing or with respect to any increase of benefits payable;
- (viii) not, except in the usual, ordinary and regular course of Business and consistent with past practice:

- (A) satisfy or settle any claims or liabilities prior to the same being due, except such as have been reserved in the UEC Financial Statements, which are, individually or in the aggregate, material; or
- (B) grant any waiver, exercise any option or relinquish any contractual rights which are, individually or in the aggregate, material;
- (ix) not settle or compromise any claim brought by any present, former or purported UEC Shareholder in connection with the transactions contemplated by this Agreement or the Merger prior to the Effective Date;
- (x) except in the usual, ordinary and regular course of Business and consistent with past practice or as required by applicable Laws, not enter into or modify in any material respect any contract, agreement, commitment or arrangement, including Material Contracts, which new contract or series of related new contracts or modification to an existing contract or series of related existing contracts which would have a Material Adverse Effect on UEC;
- (xi) promptly advise Concentric orally and, if then requested, in writing:
  - (A) of any event occurring subsequent to the Execution Date that would render any representation or warranty of UEC contained in this Agreement (except any such representation or warranty which speaks as of a date prior to the occurrence of such event), if made on or as of the date of such event or the Effective Date, untrue or inaccurate in any material respect;
  - (B) of any Material Adverse Change in respect of UEC; and
  - (C) of any material breach by UEC of any covenant or agreement contained in this Agreement; and
- (xii) use commercially reasonable efforts to comply promptly with all requirements which applicable Laws may impose on UEC with respect to the transactions contemplated hereby and by the Merger,
- (d) use commercially reasonable efforts to ensure that a satisfactory Kettell Arrangement is arrived at as soon as reasonably practicable after the Execution Date;
- (e) that, on the Execution Date, UEC will have the requisite corporate power and authority to perform its obligations hereunder; and
- (f) subject to the conditions set out herein and the Plan of Merger, to issue on the Effective Date such UEC Shares and UEC Exchange Warrants as are necessary to effect the Merger.

### Mutual Covenants

- 5.5 (a) Subject to applicable Laws, upon reasonable notice, each of UEC and Concentric shall afford the other Party's officers, employees, counsel, accountants and other authorized representatives and advisors (collectively, the "Representatives")

access, during normal business hours from the Execution Date and until the earlier of the Effective Date or the termination of this Agreement, to its properties, books, contracts and records as well as to its management personnel, and, during such period, UEC and Concentric shall furnish promptly to the other Party all information concerning that Party's business, properties and personnel as the other may reasonably request. Nothing in the foregoing shall require a Party to disclose information subject to a written confidentiality agreement with third parties or customer-specific or competitively sensitive information relating to areas or projects where a Party is in direct competition with the other.

- (b) Each of UEC and Concentric acknowledges that certain information provided to it under §5.5(a) above will be non-public and/or proprietary in nature (the "Information"). Except as permitted below, each of UEC and Concentric will keep Information confidential and will not, without the prior written consent of the other, disclose it, in any manner whatsoever, in whole or in part, to any other Person, and will not use it for any purpose other than to evaluate the transactions contemplated by this Agreement. Each of UEC and Concentric will make all reasonable, necessary and appropriate efforts to safeguard the Information from disclosure to anyone other than as permitted hereby and to control the copies, extracts or reproductions made of the Information. The Information may be provided to the Representatives of each of UEC and Concentric who require access to the same to assist it in proceeding in good faith with the transactions contemplated by this Agreement and whose assistance is required for such purposes, provided that it has first informed such Representatives to whom Information is provided that the Representative has the same obligations, including as to confidentiality, restricted use and otherwise, that it has with respect to such Information. This provision shall not apply to such portions of the Information that:
- (i) are or become generally available to the public otherwise than as a result of disclosure by a party or its Representatives;
  - (ii) become available to a Party on a non-confidential basis from a source other than, directly or indirectly, the other Party or its Representatives, provided that such source is not to the knowledge of the first party, upon reasonable inquiry, prohibited from transmitting the Information by a contractual, legal or fiduciary obligation;
  - (iii) were known to a Party or were in its possession prior to being disclosed to it by the other Party or by someone on its behalf; or
  - (iv) are required by applicable Laws or court order to be disclosed.
- (c) The Parties acknowledge that certain Information may be competitively sensitive and that disclosure thereof shall be limited to that which is reasonably necessary for the purpose of preparing submissions or applications in order to obtain any necessary regulatory approvals.
- (d) The provisions of this §5.5 shall survive the termination of this Agreement.

### Closing Matters

5.6 In addition to the requirements of Part 8, UEC and Concentric shall deliver, at the Closing, such customary certificates, opinions and other closing documents as may be required by the other Party hereto, acting reasonably, to give effect to this Agreement and the transactions contemplated hereunder.

### Indemnification of Concentric Directors and Officers

- 5.7 (a) UEC agrees that all rights to indemnification by Concentric now existing in favor of each person who is now, or has been at any time prior to the Execution Date or who becomes prior to the Effective Time an officer or director of Concentric (each an "**Indemnified Party**") as provided in Concentric's articles of incorporation or bylaws, in each case as in effect on the Execution Date, or pursuant to any other agreements in effect on the Execution Date, copies of which have been provided to UEC, including provisions relating to the advancement of expenses incurred in the defense of any action or suit, shall survive the Merger and shall remain in full force and effect for at least six years from the Effective Time. From and after the Effective Time, UEC shall be liable to pay and perform in a timely manner such indemnification obligations. UEC agrees that any claims for indemnification hereunder as to which it has received written notice prior to the sixth anniversary of the Effective Time shall survive, whether or not such claims shall have been finally adjudicated or settled prior to such anniversary. Concentric hereby represents and warrants to UEC that, to its knowledge after due inquiry, there are no claims made, pending or threatened against an Indemnified Party arising in whole or in part out of actions or omissions in his or her capacity as an officer or director of Concentric.
- (b) UEC (the "**Indemnifying Party**") shall defend and hold harmless each Indemnified Party against all losses, claims, damages, liabilities, fees, expenses, judgments and fines arising in whole or in part out of actions or omissions in their capacity as such occurring at or prior to the Effective Time, and will reimburse each Indemnified Party for any legal or other expenses reasonably incurred by such Indemnified Party in connection with investigating or defending any such losses, claims, damages, liabilities, fees, expenses, judgments and fines as such expenses are incurred, provided that nothing herein shall impair any rights of any Indemnified Party. Promptly after receipt by an Indemnified Party under this §5.7 of notice of the commencement of any action, such Indemnified Party will, if a claim in respect thereof is to be made against an Indemnifying Party under this §5.7, notify the Indemnifying Party of the commencement thereof; but the omission so to notify an Indemnifying Party will not relieve it from any liability which it may have to any Indemnified Party. In case any such action is brought against any Indemnified Party and it notifies an Indemnifying Party of the commencement thereof, the Indemnifying Party will be entitled to participate therein and, to the extent that it may wish, jointly with any other Indemnifying Party similarly notified, to assume the defense thereof, with counsel satisfactory to such Indemnified Party (who shall not, except with the consent of the Indemnified Party, be counsel to the Indemnifying Party), and after notice from the Indemnifying Party to such Indemnified Party of its election so to assume the defense thereof (and so long as the Indemnifying Party satisfies such obligations), the Indemnifying Party will not be liable to such Indemnified Party under this §5.7 for any legal or other expenses subsequently incurred by such Indemnified Party in connection with the defense thereof other than reasonable costs of

investigation. No Indemnifying Party shall, without the prior written consent of the Indemnified Party, effect any settlement of any pending or threatened action in respect of which any Indemnified Party is or could have been a party and indemnity could have been sought hereunder by such Indemnified Party unless such settlement (i) includes an unconditional release of such Indemnified Party from all liability on any claims that are the subject matter of such action and (ii) does not include a statement as to, or an admission of, fault, culpability or a failure to act by or on behalf of an Indemnified Party.

- (c) UEC shall maintain officers' and directors' liability insurance policies covering the Indemnified Parties for a period of not less than five years after the Effective Time, but only to the extent related to actions or omissions prior to the Effective Time.
- (d) The obligations of UEC under this §5.7 shall survive the consummation of the Merger and shall not be terminated or modified in such a manner as to adversely affect any Indemnified Party to whom this §5.7 applies without the consent of such affected Indemnified Party (it being expressly agreed that the Indemnified Parties to whom this §5.7 applies shall be third party beneficiaries of this §5.7, each of whom may enforce the provisions of this §5.7).
- (e) If UEC or any of its successors or assigns (i) consolidates with or merges into any other Person and shall not be the continuing or surviving corporation or entity of such consolidation or merger or (ii) transfers all or substantially all of its properties and Assets to any Person, then, and in each such case, proper provision shall be made so that the successors and assigns of UEC shall assume the obligations set forth in this §5.7.

## **PART 6** **CONDITIONS**

### **Mutual Conditions Precedent**

6.1 The respective obligations of the Parties hereto to complete the transactions contemplated by this Agreement shall be subject to the satisfaction, on or before the Effective Date, or earlier date where specified, of the following conditions precedent, each of which may only be waived in full or in part by the mutual consent of UEC and Concentric (and only to the extent such waiver is permitted by applicable Law):

- (a) the Board of Directors of UEC will have determined that the Merger is fair to the UEC Shareholders and is in the best interests of UEC;
- (b) The Board of Directors of Concentric will have:
  - (i) determined that the Merger is fair to the Concentric Shareholders and is in the best interests of Concentric;
  - (ii) to the extent required by law or if determined by UEC and Concentric to be appropriate in the circumstances, received a fairness opinion prepared for Concentric to the effect that, subject to the assumptions, qualifications and limitations relating to such opinion, as of the Execution Date, the



Merger is fair from a financial point of view to holders of Concentric Shares; and

- (iii) determined to recommend that the Concentric Shareholders vote in favor of the Merger;
- (c) the Merger shall have been approved at the Concentric Meeting by more than 50% of the votes cast by the Concentric Shareholders represented in person or by proxy at the Concentric Meeting which actually vote in favor or against the Concentric Merger Resolutions;
- (d) each of UEC and Concentric shall have completed their due diligence inspection conducted in conjunction with the Merger and the transactions contemplated herein to the satisfaction of UEC and Concentric, respectively;
- (e) there shall not be in force any order or decree restraining or enjoining the consummation of the transactions contemplated by this Agreement and there shall be no proceeding, of a judicial or administrative nature or otherwise, brought by a Governmental Entity in progress or threatened that relates to or results from the transactions contemplated by this Agreement that would, if successful, result in an order or ruling that would preclude completion of the transactions contemplated by this Agreement in accordance with the terms hereof or would otherwise be inconsistent with any Regulatory Approvals which have been obtained;
- (f) all consents, waivers, permits, orders and approvals of any Governmental Entity and the expiry of any waiting periods, in connection with, or required to permit the consummation of the Merger, the failure of which to obtain or the non-expiry of which would constitute a criminal offence, or would have a Material Adverse Effect on UEC or Concentric, as the case may be, shall have been obtained or received on terms that will not have a Material Adverse Effect on UEC and/or Concentric;
- (g) save and except for that certain and existing Involuntary Bankruptcy Petition, there shall not be pending or threatened any suit, action or proceeding by any Governmental Entity, in each case that has a reasonable likelihood of success;
  - (i) seeking to restrain or prohibit the consummation of the Merger or seeking to obtain from UEC or Concentric any damages that are material in relation to Concentric taken as a whole;
  - (ii) seeking to prohibit or materially limit the ownership or operation by UEC of any material portion of the Business or Assets of Concentric or to compel UEC to dispose of or hold separate any material portion of the Business or Assets of Concentric, as a result of the Merger;
  - (iii) seeking to prohibit UEC from effectively controlling in any material respect the Business or operations of Concentric; or
  - (iv) there is in effect any other circumstance which is reasonably likely to have a Material Adverse Effect on UEC or Concentric or the Surviving Corporation;
- (h) all necessary Regulatory Approvals shall have been obtained; and

- (i) neither Party shall have given notice to the other within 30 days of the Execution Date terminating this Agreement based on the results of the due diligence investigation conducted by the Party giving notice. It is the Parties' intention that each Party shall have a due diligence investigation period, expiring 30 days from the Execution Date, in order to conduct such due diligence investigations as the Parties deem necessary to determine the feasibility, economic or otherwise, of the transactions contemplated in this Agreement. Either Party may terminate this Agreement at any time within such 30 day period by delivery to the other of written notice of termination of this Agreement. Upon such termination, this Agreement shall be of no further force and effect. Either Party may waive the due diligence period in writing at its option.

#### **Additional Conditions Precedent to the Obligations of UEC**

6.2 The obligations of UEC to complete the transactions contemplated by this Agreement shall be subject to the fulfilment of each of the following conditions precedent (each of which is for UEC's exclusive benefit and may only be waived on behalf of UEC in full or in part by UEC):

- (a) all covenants of Concentric under this Agreement to be performed on or before the Effective Date shall have been duly performed by Concentric in all material respects;
- (b) the number of holders of Concentric Shares exercising their Concentric Dissent Rights shall not exceed 5% of the total issued and outstanding Concentric Shares;
- (c) the representations and warranties of Concentric under this Agreement shall be true and correct in all material respects as of the Effective Date as if made on and as of such date (except to the extent such representations and warranties speak as of an earlier date, in which event such representations and warranties shall be true and correct in all material respects as of such earlier date, or except as affected by transactions contemplated or permitted by this Agreement) and UEC shall have received an officer's certificate of Concentric addressed to UEC and dated the Effective Date, signed on behalf of Concentric by one senior executive officer of Concentric, confirming the same as at the Effective Date;
- (d) between the Execution Date and the Effective Date there shall not have occurred a Material Adverse Change to Concentric;
- (e) all necessary corporate action shall have been taken by Concentric to permit the consummation of the Merger;
- (f) all necessary corporate action shall have been taken by Concentric to permit the consummation of the Merger;
- (g) UEC shall be satisfied, in its sole and absolute discretion, that it is in a position to fully complete on and close its existing Global Acquisition Agreement with Global to acquire Global's Rights under the Underlying Option Agreement contemporaneously with the completion of the within Merger; and
- (h) all deliveries under Part 8 shall have been made as required of Concentric.

6.3 UEC may not rely on the failure to satisfy any of the above conditions precedent as a basis for non-compliance by UEC with its obligations under this Agreement if the condition precedent would have been satisfied but for a material default by UEC in complying with its obligations hereunder.

**Additional Conditions Precedent to the Obligations of Concentric**

6.4 The obligations of Concentric to complete the transactions contemplated by this Agreement shall be subject to the following conditions precedent (each of which is for the exclusive benefit of Concentric and may be waived in full or in part by Concentric):

- (a) all covenants of UEC under this Agreement to be performed on or before the Effective Date shall have been duly performed by UEC in all material respects;
- (b) all representations and warranties of UEC under this Agreement shall be true and correct in all material respects as of the Effective Date as if made on and as of such date (except to the extent such representations and warranties speak as of an earlier date, in which event such representations and warranties shall be true and correct in all material respects as of such earlier date, or except as affected by transactions contemplated or permitted by this Agreement) and Concentric shall have received a certificate of UEC addressed to Concentric and dated the Effective Date, signed on behalf of UEC by one senior executive officer of UEC, confirming the same as at the Effective Date;
- (c) there shall not have occurred a Material Adverse Change to UEC in the Pre-Effective Date Period;
- (d) all other necessary corporate action shall have been taken by UEC to permit the consummation of the Merger and the issue of UEC Shares and UEC Exchange Warrants pursuant to the Merger;
- (e) the Board of Directors of UEC shall have adopted all necessary resolutions, and all other necessary corporate action shall have been taken by UEC to permit the consummation of the Merger;
- (f) Concentric shall have received a satisfactory legal opinion from UEC's Lawyers as described in §8.2(b); and
- (g) all deliveries under Part 8 have been made as required of UEC.

6.5 Concentric may not rely on the failure to satisfy any of the above conditions precedent as a basis for non-compliance by Concentric with its obligations under this Agreement if the condition precedent would have been satisfied but for a material default by Concentric in complying with its obligations hereunder.

**Notice and Cure Provisions**

6.6 UEC and Concentric will give prompt notice to the other of the occurrence, or failure to occur, at any time from the Execution Date until the Effective Date, of any event or state of facts which occurrence or failure would, or would be likely to:

- (a) cause any of the representations or warranties of the other Party contained herein to be untrue or inaccurate in any material respect on the Execution Date or on the Effective Date; or
- (b) result in the failure in any material respect to comply with or satisfy any covenant, condition, or agreement to be complied with or satisfied by the other hereunder prior to the Effective Date.

6.7 Neither UEC nor Concentric may elect not to complete the transactions contemplated hereby pursuant to the conditions precedent contained in §6.1, §6.2 and §6.4 on their respective parts to be fulfilled, or exercise any termination right arising therefrom, unless forthwith and in any event prior to the filing of the Articles of Merger, UEC or Concentric, as the case may be, have delivered a written notice to the other specifying in reasonable detail all breaches of covenants, representations and warranties or other matters which UEC or Concentric, as the case may be, are asserting as the basis for the non-fulfilment of the applicable condition precedent or the exercise of the termination right, as the case may be. If any such notice is delivered, provided that UEC or Concentric, as the case may be, is proceeding diligently to cure such matter, if such matter is capable of being cured, the other Party may not terminate this Agreement as a result thereof until the expiration of a period of 30 days from such notice. If such notice has been delivered to Concentric prior to the date of the Concentric Meeting, the Concentric Meeting shall be adjourned until the expiry of such period. If such notice has been delivered prior to the filing of the Articles of Merger, such filing shall be postponed until the expiry of such period. For greater certainty, in the event that such matter is cured within the time period referred to herein, this Agreement may not be terminated.

#### **Satisfaction of Conditions**

6.8 The conditions precedent set out in §6.1, §6.2 and §6.4 shall be conclusively deemed to have been satisfied, waived or released when, with the consent of UEC and Concentric, the Articles of Merger are filed with the Secretary of State of the State of Nevada.

### **PART 7** **AMENDMENT AND TERMINATION**

#### **Amendment**

7.1 This Agreement may, at any time and from time to time before or after the holding of the Concentric Meeting, but not later than the Effective Date, be amended by mutual written agreement of the Parties hereto, and any such amendment may, without limitation:

- (a) change the time for performance of any of the obligations or acts of the Parties;
- (b) waive any inaccuracies or modify any representation contained herein or in any document delivered pursuant hereto;
- (c) waive compliance with or modify any of the covenants herein contained and waive or modify performance of any of the obligations of the Parties; and
- (d) waive compliance with or modify any conditions precedent herein contained;

provided, however, that any such change, waiver or modification does not invalidate the approval of the Concentric Shareholders of the Merger.

### Mutual Understanding Regarding Amendments

7.2 The Parties agree that if UEC or Concentric, as the case may be, proposes any amendment or amendments to this Agreement or to the Merger, the other will act reasonably in considering such amendment, and if the other (and in the case of Concentric, its shareholders) is not prejudiced by reason of any such amendment, the other will co-operate in a reasonable fashion with UEC or Concentric, as the case may be, so that such amendment can be effected subject to applicable Laws and the rights of the Concentric Shareholders and the UEC Shareholders, as applicable.

### Termination

- 7.3 (a) If any condition contained in §6.1 or §6.2 is not satisfied at or before the Termination Date to the satisfaction of UEC, then UEC may by notice to Concentric terminate this Agreement and the obligations of the Parties hereunder, except as otherwise herein provided, without detracting from the rights of UEC arising from any breach by Concentric of a covenant or representation made by it herein, which condition would have been satisfied, but for such a breach.
- (b) If any condition contained in §6.1 and §6.4 is not satisfied at or before the Termination Date to the satisfaction of Concentric, then Concentric may by notice to UEC terminate this Agreement and the obligations of the Parties hereunder, except as otherwise herein provided, without detracting from the rights of Concentric arising from any breach by UEC of a covenant or representation made by it herein, which condition would have been satisfied, but for such a breach.
- (c) The Board of Directors of Concentric may by notice to UEC terminate this Agreement if the Board of Directors of Concentric has (i) withdrawn, or modified or changed in a manner adverse to UEC its approval or recommendation of this Agreement or the Merger in order to approve and permit Concentric to execute a definitive agreement relating to a Superior Proposal, and (ii) determined in good faith, after consultation with outside legal counsel to Concentric, that the failure to take such action as set forth in the preceding clause (i) would result in a breach of the Board of Directors' fiduciary duties under applicable Nevada law, notwithstanding all terms and conditions which may be offered by UEC in negotiations entered into pursuant to the following proviso to this clause (ii); provided, however, that the Board of Directors shall not take any such action in connection with a Superior Proposal until Concentric shall have given UEC such reasonable notice of all material terms and conditions of the Superior Proposal as may be possible taking into account the terms of the Superior Proposal, and Concentric shall have, and shall have caused its respective financial and legal advisors to, negotiate in good faith with UEC to make such adjustments in the terms and conditions of this Agreement as would enable Concentric to proceed with the transactions contemplated herein on such adjusted terms.
- (d) This Agreement may:
- (i) be terminated by the mutual agreement of UEC and Concentric (without further action on the part of the Concentric Shareholders) anytime prior to the filing of the Articles of Merger;
  - (ii) be terminated by either UEC or Concentric if there shall be passed any law or regulation that makes consummation of the transactions contemplated

by this Agreement illegal or otherwise prohibited, or if any injunction, order or decree enjoining UEC or Concentric from consummating the transactions contemplated by this Agreement is entered and such injunction, order or decree shall become final and non-appealable;

- (iii) be terminated by UEC if:
  - (A) the Board of Directors of Concentric shall have failed to recommend or withdrawn or modified or changed in a manner adverse to UEC its approval or recommendation of this Agreement or the Merger, or
  - (B) this Merger is not, prior to 21 days prior to the Termination Date, submitted for the approval of the Concentric Shareholders' at the Concentric Meeting; and
- (iv) be terminated by Concentric if the Board of Directors of UEC shall have failed to recommend or withdrawn or modified or changed in a manner adverse to Concentric its approval or recommendation of this Agreement or the Merger.
- (e) If the Effective Date does not occur on or prior to the Termination Date, then this Agreement shall automatically terminate unless extended by mutual agreement.
- (f) If this Agreement is terminated in accordance with any of the foregoing provisions of this §7.3(f), no Party shall have any further liability to perform its obligations hereunder except as otherwise contemplated hereby, and provided that neither the termination of this Agreement nor anything contained in this §7.3(f) shall relieve either Party from any liability for any breach by it of this Agreement, including from any inaccuracy in its representations and warranties and any non-performance by it of its covenants made herein.

### Remedies

7.4 The Parties hereto acknowledge and agree that an award of money damages would be inadequate for any breach of this Agreement by either Party or its representatives and any such breach would cause the non-breaching party irreparable harm. Accordingly, the Parties hereto agree that, in the event of any breach or threatened breach of this Agreement by either Party, the non-breaching Party will also be entitled, without the requirement of posting a bond or other security, to equitable relief, including injunctive relief and specific performance. Such remedies will not be the exclusive remedies for any breach of this Agreement but will be in addition to all other remedies available at law or equity to each Party.

## PART 8 CLOSING

### Closing

8.1 Closing shall take place at the offices of UEC's Lawyers at 10:00 a.m. on a date to be mutually agreed upon by the Parties hereto, which shall not be later than August 31, 2011 unless mutually agreed to by the Parties hereto in writing (the "Effective Date").

## Deliveries

8.2 Prior to the Effective Date the Parties shall deliver the following documents to UEC's Lawyers which shall be held in escrow until the Parties are satisfied that all documents required to be delivered hereunder have been delivered accordingly:

- (a) Concentric shall deliver or cause to be delivered for the release, subject to §8.3, to UEC:
  - (i) executed copies of all Ancillary Agreements, if any;
  - (ii) a duly executed certificate by a senior executive officer of Concentric dated as at the Effective Date to the effect that the representations and warranties of Concentric contained in this Agreement are true and correct in all material respects and that the covenants and agreements of Concentric to be performed on or before the Effective Date pursuant to the terms of this Agreement have been duly performed in all material respects;
  - (iii) a certified copy of a resolution of the directors of Concentric duly passed, with a certification that it has not been rescinded and continues in effect, approving this Agreement, such resolution and the Merger and all matters thereunder;
  - (iv) a certified copy of the Concentric Merger Resolutions;
  - (v) any necessary waivers, consents and approvals from other parties with respect to Material Contracts should UEC determine that any are needed notwithstanding Concentric's representations to the contrary herein;
  - (vi) duly executed Articles of Merger; and
  - (vii) the favorable legal opinion of Concentric's Lawyers, in form reasonably satisfactory to UEC's Lawyers, including:
    - (A) the due authorization, execution and delivery by Concentric of this Agreement and the agreements required to be executed by Concentric pursuant thereto and that each of such agreements is a legal, valid and binding obligation of Concentric in accordance with its terms, except as may be limited by laws of general application affecting the rights of creditors generally, the effect of equitable principles and that the availability of equitable remedies is subject to the discretion of the court before which any proceedings therefor may be brought;
    - (B) as to the due incorporation, organization, and good standing with respect to the filing of annual returns of Concentric; and
    - (C) as to the corporate power and capacity of Concentric to own the Assets owned by it and to conduct the Business conducted by it;
- (b) UEC shall deliver or cause to be delivered for the release, subject to §8.3, to Concentric:

- (i) a certified copy of the UEC Merger Resolutions;
- (ii) a treasury direction addressed to the Transfer Agent directing the issuance to the former Concentric Shareholders the number of UEC Shares determined in accordance with the terms of this Agreement; provided, however, that each certificate representing any Concentric Shares, until surrendered to the Transfer Agent in exchange for a certificate representing the appropriate number of UEC Shares, shall be deemed after the Effective Time to represent the holder's right and entitlement to be recognized as the holder of record of the number of UEC Shares determined by the Exchange Ratio in accordance with this Agreement;
- (iii) a duly executed certificate of one senior executive officer of UEC dated as at the Effective Date to the effect that the representations and warranties of UEC contained in this Agreement are true and correct in all material respects and that the covenants and agreements of UEC to be performed on or before the Effective Date pursuant to the terms of this Agreement have been duly performed in all material respects;
- (iv) a certified copy of a resolution of the directors of UEC duly passed, with a certification that such resolution has not been rescinded and continues in effect, authorizing the execution, delivery and implementation of this Agreement and of all transactions contemplated hereby and of all documents to be delivered by UEC pursuant hereto; and
- (v) a favorable legal opinion of UEC's Lawyers, in form reasonably satisfactory to Concentric's Lawyer, including:
  - (A) UEC has the corporate power and capacity to execute and deliver this Agreement and complete the transactions contemplated hereby, that all corporate proceedings have been taken to complete the Merger under this Agreement, and that this Agreement and each of the other agreements required hereunder has been duly and validly authorized, executed and delivered by UEC and each such agreement is a legal, valid and binding obligation of UEC in accordance with its terms, except as may be limited by laws of general application affecting the rights of creditors generally, the effect of equitable principles, and the availability of equitable remedies is subject to the discretion of the court before which any proceedings therefor may be brought,
  - (B) the incorporation, organization and good standing in respect of the filing of annual returns of UEC,
  - (C) the due and valid issue of the UEC Shares to Concentric security holders receiving such securities; and
- (vi) duly executed Articles of Merger.

8.3 Upon the Parties being satisfied that all the required deliveries have been made according to §8.2, the documents delivered hereunder shall be released to UEC's Lawyers, for the purpose of making the filings with Governmental Entities required for the Closing to complete the Merger, and thereafter the documents will be released to the respective Parties.



**PART 9**  
**GENERAL**

**Notices**

9.1 Each notice, demand or other communication required or permitted to be given under this Agreement shall be in writing and shall be sent by prepaid registered mail deposited in a post office addressed to the Party entitled to receive the same, or delivered to such Party, at the address for such Party specified above. The date of receipt of such notice, demand or other communication shall be the date of delivery thereof if delivered, or, if given by registered mail as aforesaid, shall be deemed conclusively to be the third calendar day after the same shall have been so mailed, or 15 calendar days in the case of an addressee with an address for service in a country other than a country in which the Party giving the notice, demand or other communication resides, except in the case of interruption of postal services for any reason whatsoever, in which case the date of receipt shall be the date on which the notice, demand or other communication is actually received by the addressee.

**Change of address**

9.2 Either Party may at any time and from time to time notify the other Party in writing of a change of address and the new address to which notice shall be given to it thereafter until further change.

**Assignment**

9.3 No Party hereto may assign its rights or obligations under this Agreement or the Merger.

**Binding Effect**

9.4 This Agreement and the Merger shall be binding upon and shall enure to the benefit of the Parties and their respective successors and no third party shall have any rights hereunder.

**Waiver and Modification**

9.5 UEC and Concentric may waive or consent to the modification of, in whole or in part, any inaccuracy of any representation or warranty made to them hereunder or in any document to be delivered pursuant hereto and may waive or consent to the modification of any of the covenants herein contained for their respective benefit or waive or consent to the modification of any of the obligations of the other Party hereto. Any waiver or consent to the modification of any of the provisions of this Agreement, to be effective, must be in writing executed by the Party granting such waiver or consent.

**No Personal Liability**

9.6 (a) No director or officer of UEC shall have any personal liability whatsoever to Concentric under this Agreement, or any other document delivered in connection with this Agreement on behalf of UEC; and

- (b) No director or officer of Concentric shall have any personal liability whatsoever to UEC under this Agreement, or any other document delivered in connection with this Agreement on behalf of Concentric.

### **Further Assurances**

9.7 Each Party shall, from time to time, and at all times hereafter, at the request of the other Party, but without further consideration, do all such further acts and execute and deliver all such further documents and instruments as shall be reasonably required in order to fully perform and carry out the terms and intent hereof.

### **Expenses**

- 9.8 (a) Each Party shall otherwise be responsible for its costs in connection with the Merger; provided, however, that in the event of a successful Merger, then UEC shall be responsible for all costs of the Merger. Provided, however, that UEC may allocate expenses between UEC and Concentric after the Merger, as it determines appropriate in its sole discretion. In the event either Party terminates the Merger before it is concluded, each Party will be responsible for its own costs.
- (b) Concentric represents and warrants to UEC that no broker, finder or investment banker, is or will be entitled to any brokerage, finder's or other fee or commission from Concentric in connection with the transactions contemplated hereby or by the Merger.
- (c) UEC represents and warrants to Concentric that no broker, finder or investment banker is or will be entitled to any brokerage, finder's or other fee or commission from UEC in connection with the transactions contemplated hereby or by the Merger.

### **Consultation**

9.9 UEC and Concentric agree to consult with each other as to the general nature of any news releases or public statements with respect to this Agreement or the Merger, and to use their respective commercially reasonable efforts not to issue any news releases or public statements inconsistent with the results of such consultations. Subject to applicable Laws, each Party shall use commercially reasonable efforts to enable the other Party to review and comment on all such news releases prior to the release thereof. UEC and Concentric also agree to consult with each other in preparing and making any filings and communications in connection with any required regulatory approvals.

### **Governing Laws**

9.10 This Agreement, other than with respect to Part 2, shall be governed by and construed in accordance with the laws of the Province of British Columbia and the laws of Canada applicable therein and shall be treated in all respects as a British Columbia contract. Each Party hereby irrevocably attorns to the jurisdiction of the courts of the Province of British Columbia in respect of all matters, other than with respect to Part 2, arising under or in relation to this Agreement. Part 2 of this Agreement shall be governed by the laws of the State of Nevada and the Parties shall attorn to the jurisdiction of the courts of the State of Nevada in respect thereto, regardless of the laws that might otherwise govern under applicable conflicts of law thereof, and issues involving the corporate governance of either Party hereto shall be governed by the laws of Nevada.

**Time of Essence**

9.11 Time shall be of the essence in this Agreement.

**Counterparts**

9.12 This Agreement may be executed in one or more counterparts, each of which shall be deemed to be an original but all of which together shall constitute one and the same instrument.

**IN WITNESS WHEREOF** each of the Parties has set their respective hands and seals in the presence of their duly authorized signatories as of the Execution Date determined hereinabove.

The COMMON SEAL of  
**URANIUM ENERGY CORP.**  
was hereunto affixed in the presence of:

  
Authorized Signatory

(C/S)

The COMMON SEAL of  
**CONCENTRIC ENERGY CORP.**  
was hereunto affixed in the presence of:

  
Authorized Signatory

(C/S)

## Schedule A

This is Schedule A to that certain Merger Agreement & Plan of Merger respecting Uranium Energy Corp. and Concentric Energy Corp.

### Concentric Merger Resolutions

#### **“WHEREAS:**

- A. Concentric Energy Corp. (the “**Company**”) has entered into a merger agreement and plan of merger dated May 5, 2011 (the “**Agreement and Plan of Merger**”) with Uranium Energy Corp. (“**UEC**”), whereby the Company will merge with a wholly-owned subsidiary of UEC (“**Subco**”); and
- B. Pursuant to the Agreement and Plan of Merger, Subco will acquire all of the issued and outstanding shares, stock options and common stock purchase warrants of the Company in consideration for the issuance of shares of the common stock of UEC, and of stock options and common stock purchase warrants of UEC, on the terms and subject to the conditions of the Agreement and Plan of Merger.

#### **RESOLVED THAT:**

1. The merger of the Company with and into Subco on the terms and subject to the conditions of the Agreement and Plan of Merger is hereby approved and recommended to the stockholders of the Company;
2. The execution of the Agreement and Plan of Merger by the Company is hereby ratified and approved; and
3. Any one officer or director of the Company is hereby authorized and directed for and on behalf of the Company to call a meeting of the stockholders of the Company in order to solicit the approval of the Agreement and Plan of Merger from the stockholders of the Company, and to further execute or cause to be executed, under the seal of the Company or otherwise, and to deliver or cause to be delivered, all such other documents, agreements, amendments to agreements, and instruments and to perform or cause to be performed all such other acts and things as in such person’s opinion may be necessary or desirable to give full effect to the foregoing resolution and the matters authorized hereby, such determination to be conclusively evidenced by the execution and delivery of such document, agreement, amendment to an agreement, or instrument or the doing of any such act or thing, including but not limited to amendments to the Agreement and Plan of Merger.”

## Schedule B

This is Schedule B to that certain Merger Agreement & Plan of Merger respecting Uranium Energy Corp. and Concentric Energy Corp.

### UEC Merger Resolutions

#### **“WHEREAS:**

- A. Uranium Energy Corp. (the “**Company**”) has entered into a merger agreement and plan of merger dated May 5, 2011 (the “**Agreement and Plan of Merger**”) with Concentric Energy Corp. (“**Concentric**”), whereby Concentric will merge with a wholly-owned subsidiary of the Company (“**Subco**”); and
- B. Pursuant to the Agreement and Plan of Merger, Subco will acquire all of the issued and outstanding shares, stock options and common stock purchase warrants of Concentric in consideration for the issuance of shares of the common stock of the Company, and of stock options and common stock purchase warrants of the Company, on the terms and subject to the conditions of the Agreement and Plan of Merger.

#### **RESOLVED THAT:**

1. The merger of Concentric with and into Subco on the terms and subject to the conditions of the Agreement and Plan of Merger is hereby approved and recommended to the stockholders of the Company;
2. The execution of the Agreement and Plan of Merger by the Company is hereby ratified and approved; and
3. Any one officer or director of the Company is hereby authorized and directed for and on behalf of the Company to call a meeting of the stockholders of Subco in order to solicit the approval of the Agreement and Plan of Merger from the stockholders of Subco, and to further execute or cause to be executed, under the seal of the Company or otherwise, and to deliver or cause to be delivered, all such other documents, agreements, amendments to agreements, and instruments and to perform or cause to be performed all such other acts and things as in such person’s opinion may be necessary or desirable to give full effect to the foregoing resolution and the matters authorized hereby, such determination to be conclusively evidenced by the execution and delivery of such document, agreement, amendment to an agreement, or instrument or the doing of any such act or thing, including but not limited to amendments to the Agreement and Plan of Merger.”

**United States Department of the Interior  
Bureau of Land Management  
LANDS/RECREATION & PLANNING  
ONE N CENTRAL AVE  
PHOENIX, AZ 85004 -2203  
Phone: 602-417-9200**

Receipt

No: 2953884

<b>Transaction #:</b> 3041787	
<b>Date of Transaction:</b> 01/22/2014	
<b>CUSTOMER:</b>	
URANIUM ENERGY CORP PO BOX 2955 CORPUS CHRISTI, TX 78403-2955 US	

LINE #	QTY	DESCRIPTION	REMARKS	UNIT PRICE	TOTAL
1	1.00	LOCATABLE MINERALS / MINING CLAIMS- NOT NEW-UNADJUD, ONE AUTH NO. ONLY / MINING CLAIM MONEY RECEIVED <b>CASES: AMC366751/\$3700.00</b>	TRF - 370	- n/a -	3700.00
<b>TOTAL:</b>					<b>\$3,700.00</b>

PAYMENT INFORMATION					
1	<b>AMOUNT:</b>	3700.00	<b>POSTMARKED:</b>	01/16/2014	
	<b>TYPE:</b>	CHECK	<b>RECEIVED:</b>	01/21/2014	
	<b>CHECK NO:</b>	16014			
	<b>NAME:</b>	URANIUM ENERGY CORP 1111 W HASTINGS ST STE 320 VANCOUVER BC CANADA NS V6E 2J3 CA			

<b>REMARKS</b>

This receipt was generated by the automated BLM Collections and Billing System and is a paper representation of a portion of the official electronic record contained therein.

# PRIORITY ★ MAIL ★

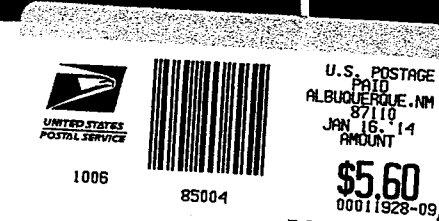

## FLAT RATE ENVELOPE ONE RATE ★ ANY WEIGHT\*

**PRIORITY**  
★ MAIL ★

UNITED STATES POSTAL SERVICE  
VISIT US AT USPS.COM\*  
ORDER FREE SUPPLIES ONLINE

FROM: Uranium Energy Corp  
PO Box 2955  
Corpus Christi, TX 78403

TO:  
United States Dept of Interior  
Bureau of Land Management  
One N. Central Ave  
Phoenix, AZ 85004

Label 228, July 2013  
FOR DOMESTIC AND INTERNATIONAL USE



EP14F July 2013  
OD: 12.5 x 9.5



\* Domestic only. \* For international shipments, the maximum weight is 4 lbs.



~~364029~~  
 364029  
 363059  
 366338  
 366751  
 361520  
 403601  
 407697  
 416412

388128  
 365258  
 366483  
 393473  
 410884  
 394954  
 414006

August 12, 2013

CERTIFIED MAIL  
9415 5118 9956 0897 3590 42

Bureau of Land Management  
One North Central Avenue, Suite 800  
Phoenix, Arizona 85004

To Whom It May Concern:

Please find attached our Assessment Fees for our mining claims as defined on the attached affidavit. Also attached is our filing fee of \$102,900.00 for 735 mining claims, check number 15339, and a self-addressed-stamped envelope for your use in returning a copy of our affidavit once recorded by your office.

Please call myself at 505-830-7707 if you have any questions.

Regards,

Palitha D. Williams  
Office Manager

Attachments

NO. OF CLAIMS	<u>735</u>
AMOUNT	<u>\$102,900.00</u>
RECEIPT NO.	<u>2857948</u>
INIT.	<u>A.H.</u>

\*\* BLM-ASO\*\*

ENTERED  
 AUG 24 2013  
 BY: RE



UNITED STATES DEPARTMENT OF THE INTERIOR  
 BUREAU OF LAND MANAGEMENT  
 DIVISION OF SUPPORT SERVICES  
 ONE NORTH CENTRAL AVENUE, SUITE 800  
 PHOENIX, ARIZONA 85004

August 12, 2013

MAINTENANCE FEES FOR: 2014

BLM Serial #	Claim Name	Twp	Rng	Sec
AMC364029	DM 122	8S	28E	29
AMC364030	DM 123	8S	28E	28, 29
AMC364031	DM 124	8S	28E	29
AMC364032	DM 125	8S	28E	28, 29
AMC364033	DM 126	8S	28E	29
AMC364034	DM 127	8S	28E	28, 29
AMC364035	DM 128	8S	28E	29
AMC364036	DM 129	8S	28E	28, 29
AMC364037	DM 130	8S	28E	29
AMC364038	DM 131	8S	28E	28, 29
AMC364039	DM 132	8S	28E	29
AMC364040	DM 133	8S	28E	28, 29
AMC364041	DM 134	8S	28E	29
AMC364042	DM 135	8S	28E	28, 29
AMC364043	DM 164	8S	28E	28
AMC364044	DM 165	8S	28E	28
AMC364045	DM 166	8S	28E	28
AMC364046	DM 167	8S	28E	28
AMC364047	DM 168	8S	28E	28
AMC364048	DM 169	8S	28E	28
AMC364049	DM 170	8S	28E	28
AMC364050	DM 171	8S	28E	28
AMC364051	DM 172	8S	28E	28
AMC364052	DM 173	8S	28E	28
AMC364053	DM 174	8S	28E	28
AMC364054	DM 175	8S	28E	28
AMC364055	DM 176	8S	28E	28
AMC364056	DM 177	8S	28E	28
AMC363059	CG 1	12N	13W	35
AMC363060	CG 2	12N	13W	35
AMC363061	CG 3	12N	13W	35
AMC363062	CG 4	12N	13W	35
AMC363063	CG 5	12N	13W	35

AMC363064	CG 6	12N	13W	35
AMC363065	CG 7	12N	13W	35
AMC363066	CG 8	12N	13W	35
AMC363067	CG 9	12N	13W	35
AMC363068	CG 10	12N	13W	27
AMC363069	CG 11	12N	13W	27
AMC363070	CG 12	12N	13W	27
AMC363071	CG 13	12N	13W	27
AMC363072	CG 14	12N	13W	27
AMC363073	CG 15	12N	13W	27
AMC363074	CG 16	12N	13W	27
AMC363075	CG 17	12N	13W	27
AMC363076	CG 18	12N	13W	27
AMC363077	CG 19	12N	13W	27
AMC366338	CG 20	12N	13W	36
AMC366339	CG 21	12N	13W	36
AMC366340	CG 22	12N	13W	36
AMC366341	CG 23	12N	13W	36
AMC366342	CG 24	12N	13W	36
AMC366343	CG 25	12N	13W	36
AMC366344	CG 26	12N	13W	36
AMC366345	CG 27	12N	13W	36
AMC366346	CG 28	12N	13W	36
AMC366347	CG 29	12N	13W	36
AMC366348	CG 30	12N	13W	36
AMC366349	CG 31	12N	13W	36
AMC366350	CG 32	12N	13W	36
AMC366351	CG 33	12N	13W	36
AMC366352	CG 34	12N	13W	36
AMC366353	CG 35	12N	13W	35, 36
AMC366354	CG 36	12N	13W	36
AMC366355	CG 37	12N	13W	36
AMC366356	CG 38	12N	13W	36
AMC366357	CG 39	12N	13W	36
AMC366358	CG 40	12N	13W	36
AMC366359	CG 41	12N	13W	36
AMC366360	CG 42	12N	13W	36
AMC366361	CG 43	12N	13W	36
AMC366362	CG 44	12N	12W	31
AMC366363	CG 45	12N	12W	31
AMC366364	CG 46	12N	13W	35
AMC366365	CG 47	12N	13W	35
AMC366366	CG 48	12N	13W	35
AMC366367	CG 49	12N	13W	35
AMC366368	CG 50	12N	13W	35
AMC366751	CE 1	11N	10W	11
AMC366752	CE 2	11N	10W	11

This is a list of items.

RECEIVED  
 10/10/2010

AMC366753	CE 3	11N	10W	11
AMC366754	CE 4	11N	10W	11
AMC366755	CE 5	11N	10W	11
AMC366756	CE 6	11N	10W	11
AMC366757	CE 7	11N	10W	11
AMC366758	CE 8	11N	10W	10
AMC366759	TH 1	11N	10W	10
AMC361520	AM 1	11N	10W	15, 16
AMC361521	AM 2	11N	10W	15
AMC361522	AM 3	11N	10W	15, 16
AMC361523	AM 4	11N	10W	15
AMC361524	AM 5	11N	10W	15, 16
AMC361525	AM 6	11N	10W	15
AMC361526	AM 7	11N	10W	15, 16
AMC361527	AM 8	11N	10W	15, 22
AMC361528	AM 9	11N	10W	15, 16
AMC361529	AM 10	11N	10W	15, 22
AMC361530	AM 11	11N	10W	15, 16, 21, 22
AMC361531	AM 12	11N	10W	22
AMC361532	AM 13	11N	10W	21, 22
AMC361533	AM 14	11N	10W	21, 22
AMC361534	AM 15	11N	10W	21, 22
AMC361535	AM 16	11N	10W	21, 22
AMC361536	AM 17	11N	10W	21
AMC361537	AM 18	11N	10W	21, 22
AMC361538	AM 19	11N	10W	21
AMC361539	AM 20	11N	10W	21, 22
AMC361540	AM 21	11N	10W	21
AMC361541	AM 22	11N	10W	21, 22
AMC361542	AM 23	11N	10W	21
AMC361543	AM 24	11N	10W	21, 22
AMC361544	AM 25	11N	10W	15, 22
AMC361545	AM 26	11N	10W	22
AMC361546	AM 27	11N	10W	22
AMC361547	AM 28	11N	10W	22
AMC361548	AM 29	11N	10W	22
AMC361549	AM 30	11N	10W	22
AMC361550	AM 31	11N	10W	22
AMC361551	AM 32	11N	10W	22
AMC361552	AM 33	11N	10W	22
AMC361553	AM 34	11N	10W	22
AMC361554	AM 35	11N	10W	22
AMC361555	AM 36	11N	10W	22
AMC361556	AM 37	11N	10W	22
AMC361557	AM 38	11N	10W	22
AMC361558	AM 39	11N	10W	22
AMC361559	AM 40	11N	10W	22, 27

AMC361560	AM 41	11N	10W	22
AMC361561	AM 42	11N	10W	22, 27
AMC361562	AM 43	11N	10W	22, 27
AMC361563	AM 44	11N	10W	27
AMC361564	AM 45	11N	10W	27
AMC361565	AM 46	11N	10W	11
AMC361566	AM 47	11N	10W	11
AMC361567	AM 48	11N	10W	11, 14
AMC361568	AM 49	11N	10W	11
AMC361569	AM 50	11N	10W	11, 14
AMC361570	AM 51	11N	10W	11, 14
AMC361571	AM 52	11N	10W	14
AMC361572	AM 53	11N	10W	11, 14
AMC361573	AM 54	11N	10W	14
AMC361574	AM 55	11N	10W	14
AMC361575	AM 56	11N	10W	14
AMC361576	AM 57	11N	10W	14
AMC361577	AM 58	11N	10W	14
AMC361578	AM 59	11N	10W	14
AMC361579	AM 60	11N	10W	14
AMC361580	AM 61	11N	10W	14
AMC361581	AM 62	11N	10W	14
AMC361582	AM 63	11N	10W	14
AMC361583	AM 64	11N	10W	14
AMC361584	AM 65	11N	10W	14
AMC361585	AM 66	11N	10W	14
AMC361586	AM 67	11N	10W	14
AMC361587	AM 68	11N	10W	14, 15
AMC361588	AM 69	11N	10W	14, 23
AMC361589	AM 70	11N	10W	14, 15, 23
AMC361590	AM 71	11N	10W	23
AMC361591	AM 72	11N	10W	14, 15, 22, 23
AMC361592	AM 73	11N	10W	23
AMC361593	AM 74	11N	10W	22, 23
AMC361594	AM 75	11N	10W	23
AMC361595	AM 76	11N	10W	22, 23
AMC361596	AM 77	11N	10W	23
AMC361597	AM 78	11N	10W	22, 23
AMC361598	AM 79	11N	10W	23
AMC361599	AM 80	11N	10W	22, 23
AMC361600	AM 81	11N	10W	23
AMC361601	AM 82	11N	10W	22, 23
AMC361602	AM 83	11N	10W	23
AMC361603	AM 84	11N	10W	23
AMC361604	AM 85	11N	10W	23
AMC361605	AM 86	11N	10W	22, 23
AMC361606	AM 87	11N	10W	22, 23, 26, 27
			10W	22, 27

THE INFORMATION CONTAINED  
 HEREIN IS UNCLASSIFIED  
 DATE 08-14-2013 BY 60322 UCBAW

AMC361607	AM 88	11N	10W	26, 27
AMC361608	AM 89	11N	10W	22, 27
AMC361609	AM 90	11N	10W	26, 27
AMC361610	AM 91	11N	10W	27
AMC361611	AM 92	11N	10W	26, 27
AMC361612	AM 93	11N	10W	27
AMC361613	AM 94	11N	10W	26, 27
AMC361614	AM 95	11N	10W	27
AMC361615	AM 96	11N	10W	26, 27
AMC361616	AM 97	11N	10W	27
AMC361617	AM 98	11N	10W	26, 27
AMC361618	AM 99	11N	10W	27
AMC361619	AM 100	11N	10W	26, 27
AMC361620	AM 101	11N	10W	27
AMC361621	AM 102	11N	10W	26, 27
AMC361622	AM 103	11N	10W	27
AMC361623	AM 104	11N	10W	26, 27, 34
AMC361624	AM 105	11N	10W	11, 12
AMC361625	AM 106	11N	10W	12, 13
AMC361626	AM 107	11N	10W	11, 12, 13, 14
AMC361627	AM 108	11N	10W	12, 13
AMC361628	AM 109	11N	10W	13, 14
AMC361629	AM 110	11N	10W	13
AMC361630	AM 111	11N	10W	13, 14
AMC361631	AM 112	11N	10W	13
AMC361632	AM 113	11N	10W	13, 14
AMC361633	AM 114	11N	10W	13
AMC361634	AM 115	11N	10W	13, 14
AMC361635	AM 116	11N	10W	13, 14
AMC361636	AM 117	11N	10W	14
AMC361637	AM 118	11N	10W	13, 14
AMC361638	AM 119	11N	10W	14
AMC361639	AM 120	11N	10W	13, 14
AMC361640	AM 121	11N	10W	14
AMC361641	AM 122	11N	10W	13, 14
AMC361642	AM 123	11N	10W	14
AMC361643	AM 124	11N	10W	13, 14, 24
AMC361644	AM 125	11N	10W	14, 23
AMC361645	AM 126	11N	10W	13, 14, 24
AMC361646	AM 127	11N	10W	23
AMC361647	AM 128	11N	10W	23, 24
AMC361648	AM 129	11N	10W	23
AMC361649	AM 130	11N	10W	23, 24
AMC361650	AM 131	11N	10W	23
AMC361651	AM 132	11N	10W	23, 24
AMC361652	AM 133	11N	10W	23
AMC361653	AM 134	11N	10W	23

AMC361654	AM 135	11N	10W	23
AMC361655	AM 136	11N	10W	23
AMC361656	AM 137	11N	10W	23
AMC361657	AM 138	11N	10W	23
AMC361658	AM 139	11N	10W	23
AMC361659	AM 140	11N	10W	23
AMC361660	AM 141	11N	10W	23
AMC361661	AM 142	11N	10W	23, 26
AMC361662	AM 143	11N	10W	23, 26
AMC361663	AM 144	11N	10W	23, 26
AMC361664	AM 145	11N	10W	23, 26
AMC361665	AM 146	11N	10W	26
AMC361666	AM 147	11N	10W	26
AMC361667	AM 148	11N	10W	26
AMC361668	AM 149	11N	10W	26
AMC361669	AM 150	11N	10W	26
AMC361670	AM 151	11N	10W	26
AMC361671	AM 152	11N	10W	26
AMC361672	AM 153	11N	10W	26
AMC361673	AM 154	11N	10W	26
AMC361674	AM 155	11N	10W	26
AMC361675	AM 156	11N	10W	26
AMC361676	AM 157	11N	10W	26
AMC361677	AM 158	11N	10W	26
AMC361678	AM 159	11N	10W	26
AMC361679	AM 160	11N	10W	26, 35
AMC361680	AM 161	11N	10W	26, 35
AMC361681	AM 162	11N	10W	26, 35
AMC361682	AM 163	11N	10W	12, 13
AMC361683	AM 164	11N	10W	13
AMC361684	AM 165	11N	10W	13
AMC361685	AM 166	11N	10W	13
AMC361686	AM 167	11N	10W	13
AMC361687	AM 168	11N	10W	13
AMC361688	AM 169	11N	10W	13
AMC361689	AM 170	11N	10W	13
AMC361690	AM 171	11N	10W	13
AMC361691	AM 172	11N	10W	13
AMC361692	AM 173	11N	10W	13
AMC361693	AM 174	11N	10W	13
AMC361694	AM 175	11N	10W	13
AMC361695	AM 176	11N	10W	13
AMC361696	AM 177	11N	10W	13
AMC361697	AM 178	11N	10W	13
AMC361698	AM 179	11N	10W	13
AMC361699	AM 180	11N	10W	13, 24
AMC361700	AM 181	11N	10W	13, 24

RECEIVED  
 DIVISION OF...  
 JUN 11 1968

AMC361701	AM 182	11N	10W	24
AMC361702	AM 183	11N	10W	24
AMC361703	AM 184	11N	10W	24
AMC361704	AM 185	11N	10W	24
AMC361705	AM 186	11N	10W	24
AMC361706	AM 187	11N	10W	24
AMC361707	AM 188	11N	10W	24
AMC361708	AM 189	11N	10W	24
AMC361709	AM 190	11N	10W	24
AMC361710	AM 191	11N	10W	23, 24
AMC361711	AM 192	11N	10W	24
AMC361712	AM 193	11N	10W	23, 24
AMC361713	AM 194	11N	10W	24
AMC361714	AM 195	11N	10W	23, 24
AMC361715	AM 196	11N	10W	24
AMC361716	AM 197	11N	10W	23, 24
AMC361717	AM 198	11N	10W	24, 25
AMC361718	AM 199	11N	10W	23, 24, 25, 26
AMC361719	AM 200	11N	10W	24, 25
AMC361720	AM 201	11N	10W	25, 26
AMC361721	AM 202	11N	10W	25
AMC361722	AM 203	11N	10W	25, 26
AMC361723	AM 204	11N	10W	25
AMC361724	AM 205	11N	10W	25, 26
AMC361725	AM 206	11N	10W	25
AMC361726	AM 207	11N	10W	25, 26
AMC361727	AM 208	11N	10W	25
AMC361728	AM 209	11N	10W	25, 26
AMC361729	AM 210	11N	10W	25, 26
AMC361730	AM 211	11N	10W	25, 26
AMC361731	AM 212	11N	10W	25, 26
AMC361732	AM 213	11N	10W	25, 26
AMC361733	AM 214	11N	10W	25, 26
AMC361734	AM 215	11N	10W	25, 26
AMC361735	AM 216	11N	10W	25, 26, 36
AMC388128	AM 217	11N	10W	9, 10
AMC388129	AM 218	11N	10W	9, 10
AMC388130	AM 219	11N	10W	9, 10
AMC388131	AM 220	11N	10W	10
AMC388132	AM 221	11N	10W	10
AMC388133	AM 222	11N	10W	10
AMC388134	AM 223	11N	10W	3, 10
AMC388135	AM 224	11N	10W	10
AMC388136	AM 225	11N	10W	3
AMC388137	AM 226	11N	10W	3
AMC388138	AM 227	11N	10W	3
AMC388139	AM 228	11N	10W	3

AMC388140	AM 229	11N	10W	3
AMC388141	AM 230	11N	10W	3
AMC388142	AM 231	11N	10W	10, 11
AMC388143	AM 232	11N	10W	11
AMC388144	AM 233	11N	10W	10, 11
AMC388145	AM 234	11N	10W	11
AMC388146	AM 235	11N	10W	2, 3, 10, 11
AMC388147	AM 236	11N	10W	11
AMC388148	AM 237	11N	10W	2, 3, 11
AMC388149	AM 238	11N	10W	2, 11
AMC388150	AM 239	11N	10W	11
AMC388151	AM 240	11N	10W	11
AMC388152	AM 241	11N	10W	11
AMC388153	AM 242	11N	10W	11
AMC388154	AM 243	11N	10W	11
AMC388155	AM 244	11N	10W	11
AMC388156	AM 245	11N	10W	11
AMC361736	AM 246	11N	10W	10
AMC361737	AM 247	11N	10W	10
AMC361738	AM 248	11N	10W	10, 11
AMC361739	AM 249	11N	10W	11
AMC361740	AM 250	11N	10W	11
AMC361741	AM 251	11N	10W	11
AMC361742	AM 252	11N	10W	11
AMC361743	AM 253	11N	10W	11
AMC361744	AM 254	11N	10W	9, 15, 16
AMC361745	AM 255	11N	10W	9, 16
AMC361746	AM 256	11N	10W	9, 10, 15
AMC361747	AM 257	11N	10W	9
AMC361748	AM 258	11N	10W	9, 10
AMC361749	AM 259	11N	10W	9
AMC361750	AM 260	11N	10W	9, 10
AMC361751	AM 261	11N	10W	9
AMC361752	AM 262	11N	10W	9, 10
AMC361753	AM 263	11N	10W	9
AMC361754	AM 264	11N	10W	27, 34
AMC365258	AM 265	11N	10W	10, 11
AMC365259	AM 266	11N	10W	11
AMC365260	AM 267	11N	10W	10, 11
AMC365261	AM 268	11N	10W	10, 11
AMC365262	AM 269	11N	10W	10, 11
AMC365263	AM 270	11N	10W	10, 11
AMC365264	AM 271	11N	10W	10, 11, 15
AMC365265	AM 272	11N	10W	10, 11, 14, 15
AMC365266	AM 273	11N	10W	10, 15
AMC365267	AM 274	11N	10W	14, 15
AMC365268	AM 275	11N	10W	15

PROPOSED  
 DUNBAR ST  
 100' W. 100' N. 100' E.



AMC365269	AM 276	11N	10W	14, 15
AMC365270	AM 277	11N	10W	15
AMC365271	AM 278	11N	10W	14, 15
AMC365272	AM 279	11N	10W	15
AMC365273	AM 280	11N	10W	14, 15
AMC365274	AM 281	11N	10W	15
AMC365275	AM 282	11N	10W	14, 15
AMC365276	AM 283	11N	10W	15
AMC365277	AM 284	11N	10W	14, 15
AMC365278	AM 285	11N	10W	15
AMC365279	AM 286	11N	10W	14, 15
AMC365280	AM 287	11N	10W	10
AMC365281	AM 288	11N	10W	10
AMC365282	AM 289	11N	10W	10
AMC365283	AM 290	11N	10W	10
AMC365284	AM 291	11N	10W	10
AMC365285	AM 292	11N	10W	10, 15
AMC365286	AM 293	11N	10W	10, 15
AMC365287	AM 294	11N	10W	10, 15
AMC365288	AM 295	11N	10W	15
AMC365289	AM 296	11N	10W	15
AMC365290	AM 297	11N	10W	15, 16
AMC365291	AM 298	11N	10W	15
AMC365292	AM 299	11N	10W	15, 16
AMC365293	AM 300	11N	10W	15
AMC365294	AM 301	11N	10W	15
AMC366483	AM 302	11N	10W	9, 10
AMC366484	AM 303	11N	10W	10
AMC366485	AM 304	11N	10W	10
AMC366486	AM 305	11N	10W	10
AMC366487	AM 306	11N	10W	10
AMC366488	AM 307	11N	10W	10
AMC366489	AM 308	11N	10W	10, 11
AMC366490	AM 309	11N	10W	11
AMC388157	AM 310	11N	10W	11, 12
AMC388158	AM 311	11N	10W	2, 11
AMC388159	AM 312	11N	10W	2, 11, 12
AMC388160	AM 313	11N	10W	1, 2, 11, 12
AMC388161	AM 314	11N	10W	12
AMC388162	AM 315	11N	10W	12
AMC388163	AM 316	11N	10W	12
AMC388164	AM 317	11N	10W	11, 12
AMC388165	AM 318	11N	10W	12
AMC388166	AM 319	11N	10W	11, 12
AMC388167	AM 320	11N	10W	12
AMC388168	AM 321	11N	10W	11, 12
AMC388169	AM 322	11N	10W	12

AMC388170	AM 323	11N	10W	11, 12
AMC388171	AM 324	11N	10W	12
AMC388172	AM 325	11N	10W	13
AMC388173	AM 326	11N	10W	13
AMC388174	AM 327	11N	9W/10W	18/13
AMC388175	AM 328	11N	9W/10W	18, 19/13, 24
AMC388176	AM 329	11N	9W	18, 19
AMC388177	AM 330	11N	10W	13, 24
AMC388178	AM 331	11N	9W/10W	19/ 24
AMC388179	AM 332	11N	10W	24
AMC388180	AM 333	11N	9W/10W	19/ 24
AMC388181	AM 334	11N	10W	24
AMC388182	AM 335	11N	9W/10W	19/ 24
AMC388183	AM 336	11N	10W	24
AMC388184	AM 337	11N	9W/10W	19/ 24
AMC388185	AM 338	11N	10W	24
AMC388186	AM 339	11N	9W/10W	19/ 24
AMC388187	AM 340	11N	10W	24
AMC388188	AM 341	11N	9W/10W	19/ 24
AMC388189	AM 342	11N	10W	24
AMC388190	AM 343	11N	9W/10W	19/ 24
AMC388191	AM 344	11N	10W	24
AMC388192	AM 345	11N	9W/10W	19/ 24
AMC388193	AM 346	11N	10W	24, 25
AMC388194	AM 347	11N	9W/10W	19, 30/24, 25
AMC388195	AM 348	11N	10W	24, 25
AMC388196	AM 349	11N	10W	25
AMC388197	AM 350	11N	10W	25
AMC388198	AM 351	11N	10W	25
AMC388199	AM 352	11N	10W	25
AMC388200	AM 353	11N	10W	25
AMC388201	AM 354	11N	10W	25
AMC388202	AM 355	11N	10W	25
AMC388203	AM 356	11N	10W	25
AMC388204	AM 357	11N	10W	25
AMC393473	AM 358	11N	10W	21
AMC393474	AM 359	11N	10W	21
AMC393475	AM 360	11N	10W	21
AMC393476	AM 361	11N	10W	21
AMC410892	AP 9	11N	10W	9
AMC410893	AP 10	11N	10W	9
AMC410894	AP 11	11N	10W	9
AMC410895	AP 12	11N	10W	9
AMC410896	AP 13	11N	10W	9
AMC410897	AP 14	11N	10W	9
AMC410898	AP 15	11N	10W	9
AMC410899	AP 16	11N	10W	9

RECEIVED  
 DIVISION OF...  
 JUN 10 10 40 AM '04

AMC410900	AP 17	11N	10W	9, 16
AMC410901	AP 18	11N	10W	9, 16
AMC410905	AP 22	11N	10W	9, 10
AMC410907	AP 24	11N	10W	9, 10
AMC410909	AP 26	11N	10W	9, 10
AMC410910	AP 27	11N	10W	9
AMC410911	AP 28	11N	10W	9, 10
AMC410913	AP 30	11N	10W	10
AMC410914	AP 31	11N	10W	1, 2, 11, 12
AMC410915	AP 32	11N	10W	1
AMC410916	AP 33	11N	10W	12
AMC410917	AP 34	11N	10W	12
AMC410918	AP 35	11N	10W	12
AMC410919	AP 36	11N	10W	12
AMC410920	AP 37	11N	10W	1, 12
AMC410922	AP 39	11N	10W	12
AMC410923	AP 40	11N	9W	7, 12
AMC410924	AP 41	11N	10W	12
AMC410925	AP 42	11N	9W	7, 12
AMC410926	AP 43	11N	10W	12
AMC410927	AP 44	11N	9W	7, 12
AMC410928	AP 45	11N	10W	12
AMC410929	AP 46	11N	9W	7, 12
AMC410930	AP 47	11N	10W	12
AMC410931	AP 48	11N	9W	7, 12
AMC410932	AP 49	11N	10W	12
AMC410933	AP 50	11N	9W	7, 12
AMC410934	AP 51	11N	10W	12
AMC410935	AP 52	11N	9W	7, 12
AMC410936	AP 53	11N	10W	13, 12
AMC410937	AP 54	11N	9W/10W	7, 18/13, 12
AMC410938	AP 55	11N	9W/10W	18/13
AMC410939	AP 56	11N	9W/10W	18/13
AMC410940	AP 57	11N	9W/10W	18/13
AMC410941	AP 58	11N	10W	25
AMC410942	AP 59	11N	10W	25
AMC410943	AP 60	11N	10W	25
AMC410944	AP 61	11N	10W	25
AMC410945	AP 62	11N	10W	25
AMC410946	AP 63	11N	10W	25
AMC410947	AP 64	11N	10W	25
AMC410948	AP 65	11N	10W	25
AMC410949	AP 66	11N	10W	25
AMC410950	AP 67	11N	10W	25
AMC410951	AP 68	11N	10W	25
AMC410952	AP 69	11N	10W	25
AMC410953	AP 70	11N	10W	25

AMC410954	AP 71	11N	10W	25
AMC410955	AP 72	11N	10W	25
AMC410956	AP 73	11N	10W	25
AMC410957	AP 74	11N	10W	16, 17, 20, 21
AMC410958	AP 75	11N	10W	20, 21
AMC410959	AP 76	11N	10W	20, 21
AMC410960	AP 77	11N	10W	21
AMC410961	AP 78	11N	10W	20, 21
AMC410962	AP 79	11N	10W	21
AMC410963	AP 80	11N	10W	20, 21
AMC410964	AP 81	11N	10W	21
AMC410965	AP 82	11N	10W	20, 21
AMC410966	AP 83	11N	10W	21
AMC410967	AP 84	11N	10W	20, 21
AMC410968	AP 85	11N	10W	21
AMC410969	AP 86	11N	10W	20, 21
AMC410970	AP 87	11N	10W	21
AMC410971	AP 88	11N	10W	20, 21, 28, 29
AMC410972	AP 89	11N	10W	21, 28
AMC410973	AP 90	11N	10W	21
AMC410974	AP 91	11N	10W	21
AMC410975	AP 92	11N	10W	21
AMC410976	AP 93	11N	10W	21, 22
AMC410977	AP 94	11N	10W	21
AMC410978	AP 95	11N	10W	21, 22
AMC410979	AP 96	11N	10W	21
AMC410980	AP 97	11N	10W	21, 22
AMC410981	AP 98	11N	10W	21
AMC410982	AP 99	11N	10W	21, 22
AMC410983	AP 100	11N	10W	21, 28
AMC410984	AP 101	11N	10W	21, 22, 27, 28
AMC410985	AP 102	11N	10W	22
AMC410986	AP 103	11N	10W	13, 18
AMC410987	AP 104	11N	10W	13, 18
AMC403611	Oak 1	5N	14E	28
AMC403612	Oak 2	5N	14E	28
AMC403613	Oak 3	5N	14E	28
AMC403614	Oak 4	5N	14E	27
AMC403615	Oak 5	5N	14E	27
AMC403616	Oak 6	5N	14E	27
AMC403617	Oak 7	5N	14E	27
AMC403618	Oak 8	5N	14E	27
AMC403619	Oak 9	5N	14E	28
AMC403620	Oak 10	5N	14E	28
AMC403601	Bak 1	6N	14E	20
AMC403602	Bak 2	6N	14E	20
AMC403603	Bak 3	6N	14E	20

403601  
to  
403620

PROTECTED DOCUMENT  
 10-17-10 10:30 AM

AMC403604	Bak 4	6N	14E	20
AMC403605	Bak 5	6N	14E	20
AMC403606	Bak 6	6N	14E	29
AMC403607	Bak 7	6N	14E	29
AMC403608	Bak 8	6N	14E	29
AMC403609	Bak 9	6N	14E	29
AMC403610	Bak 10	6N	14E	20
AMC394981	RC 10	6N	14E	17
AMC394982	RC 11	6N	14E	17
AMC394983	RC 12	6N	14E	17
AMC394984	RC 13	6N	14E	17
AMC394985	RC 14	6N	14E	17
AMC394986	RC 15	6N	14E	18
AMC394987	RC 16	6N	14E	18
AMC394988	RC 17	6N	14E	18
AMC394989	RC 18	6N	14E	18
AMC394990	RC 19	6N	14E	18
AMC394991	RC 20	6N	14E	17
AMC394992	RC 21	6N	14E	17
AMC394993	RC 22	6N	14E	17
AMC394994	RC 23	6N	14E	17
AMC394995	RC 24	6N	14E	17
AMC403621	Pen 1	7N	14E	2, 11
AMC403622	Pen 2	7N	14E	2, 1, 11, 12
AMC403623	Pen 3	7N	14E	1, 12
AMC403624	Pen 4	7N	14E	1, 12
AMC403625	Pen 5	7N	14E	1, 12
AMC403626	Pen 6	7N	14E	1, 12
AMC403627	Pen 7	7N	14E	1, 12
AMC403628	Pen 9	7N	14E	1, 12
AMC403629	Pen 10	7N	14E	12
AMC403630	Pen 11	7N	14E	12
AMC403631	Pen 12	7N	14E	12
AMC403632	Pen 13	7N	14E	12
AMC403633	Pen 14	7N	14E	12
AMC403634	Pen 15	7N	14E	12
AMC403635	Pen 16	7N	14E	11, 12
AMC403636	Pen 17	7N	14E	12
AMC403637	Pen 18	7N	14E	12
AMC403638	Pen 19	7N	14E	12
AMC403639	Pen 20	7N	14E	12
AMC403640	Pen 21	7N	14E	12
AMC403641	Pen 22	7N	14E	12
AMC403642	Pen 23	7N	14E	12
AMC403643	Pen 24	7N	14E	12
AMC403644	Pen 25	7N	14E	12
AMC403645	Pen 26	7N	14E	12

2000-01-12 11:11 AM  
 2000-01-12 11:11 AM  
 2000-01-12 11:11 AM

AMC403646	Pen 27	7N	14E	12
AMC403647	Pen 28	7N	14E	12
AMC403648	Pen 29	7N	14E	12
AMC403649	Pen 30	7N	14E	11, 12
AMC403650	Pen 31	7N	14E	11
AMC403651	Pen 32	7N	14E	11, 14
AMC403652	Pen 33	7N	14E	11, 14, 12, 13
AMC403653	Pen 34	7N	14E	12, 13
AMC403654	Pen 35	7N	14E	12, 13
AMC403655	Pen 36	7N	14E	12, 13
AMC403656	Pen 37	7N	14E	12, 13
AMC403657	Pen 38	7N	14E	12, 13
AMC407697	CS 1	6N	14E	19
AMC407698	CS 2	6N	14E	19
AMC407699	CS 3	6N	14E	19
AMC407700	CS 4	6N	14E	19, 20
AMC407701	CS 5	6N	14E	20
AMC407702	CS 6	6N	14E	20
AMC407703	CS 7	6N	14E	20
AMC407704	CS 8	6N	14E	20
AMC407705	CS 9	6N	14E	20
AMC407706	CS 10	6N	14E	20
AMC407707	CS 11	6N	14E	20
AMC407708	CS 12	6N	14E	20
AMC407709	CS 13	6N	14E	20
AMC407710	CS 14	6N	14E	19, 20
AMC407711	CS 15	6N	14E	19
AMC407712	CS 16	6N	14E	19
AMC407713	CS 17	6N	14E	19
AMC407714	CS 18	6N	14E	19
AMC407715	CS 19	6N	14E	19
AMC407716	CS 20	6N	14E	19, 20
AMC407717	CS 21	6N	14E	20
AMC407718	CS 22	6N	14E	20
AMC407719	CS 23	6N	14E	20
AMC407720	CS 24	6N	14E	20
AMC407721	CS 25	6N	14E	20, 29
AMC407722	CS 26	6N	14E	20, 29
AMC407723	CS 27	6N	14E	20, 29
AMC407724	CS 28	6N	14E	18
AMC407725	CS 29	6N	14E	18
AMC407726	CS 30	6N	14E	18
AMC407727	CS 31	6N	14E	18
AMC414006	WC 62	6N	14E	19
AMC414007	WC 63	6N	14E	18, 19
AMC414008	WC 64	6N	14E	19
AMC414009	WC 65	6N	14E	19
				19, 20, 29

AMC416412	WC 66	T6N	R14E	18, 19
AMC416413	WC 67	T6N	R14E	18, 19
AMC416414	WC 68	T6N	R14E	18, 19
AMC416415	WC 69	T6N	R13E	24
AMC416416	WC 70	T6N	R13E	24
AMC416417	WC 71	T6N	R13/14E	24/19
AMC416418	WC 72	T6N	R13/14E	24/19
AMC416419	WC 73	T6N	R14E	19
AMC416420	WC 74	T6N	R14E	19
AMC416421	WC 75	T6N	R14E	19
AMC416422	WC 76	T6N	R14E	19
AMC416423	WC 77	T6N	R14E	19
AMC416424	WC 78	T6N	R14E	19
AMC416425	WC 79	T6N	R14E	19
AMC416426	WC 80	T6N	R14E	19
AMC416427	WC 81	T6N	R14E	19
AMC416428	WC 82	T6N	R14E	19
AMC416429	WC 83	T6N	R14E	19, 30
AMC416430	WC 84	T6N	R14E	19
AMC416431	WC 85	T6N	R14E	19, 30
AMC416432	WC 86	T6N	R14E	19
AMC416433	WC 87	T6N	R14E	19, 30
AMC416434	WC 88	T6N	R14E	19
AMC416435	WC 89	T6N	R14E	19, 30
AMC416436	WC 90	T6N	R14E	19
AMC416437	WC 91	T6N	R14E	19, 30
AMC416438	WC 92	T6N	R14E	19, 30
AMC416439	WC 93	T6N	R14E	19, 30
AMC416440	WC 94	T6N	R14E	19, 30
AMC416441	WC 95	T6N	R14E	19, 20, 29, 30
AMC416442	WC 96	T6N	R13/14E	25/30
AMC416443	WC 97	T6N	R14E	25/30
AMC416444	WC 98	T6N	R14E	30
AMC416445	WC 99	T6N	R14E	30
AMC416446	WC 100	T6N	R14E	30
AMC416447	WC 101	T6N	R14E	30
AMC416448	WC 102	T6N	R14E	30
AMC416449	WC 103	T6N	R14E	30
AMC416450	WC 104	T6N	R14E	30
AMC416451	WC 105	T6N	R14E	30
AMC416452	WC 106	T6N	R14E	30
AMC416453	WC 107	T6N	R14E	30
AMC416454	WC 108	T6N	R14E	30
AMC416455	WC 109	T6N	R14E	30
AMC416456	WC 110	T6N	R14E	30
AMC416457	WC 111	T6N	R14E	30
AMC416458	WC 112	T6N	R14E	30

AMC416459	WC 113	T6N	R14E	30
AMC416460	WC 114	T6N	R14E	29, 30
AMC416461	WC 115	T6N	R14E	29, 30
AMC416462	WC 116	T6N	R14E	29
AMC416463	WC 117	T6N	R14E	29
AMC416464	WC 118	T6N	R14E	29
AMC416465	WC 119	T6N	R14E	29
AMC416466	WC 120	T6N	R14E	29
AMC416467	WC 121	T6N	R14E	29
AMC416468	WC 122	T6N	R14E	29
AMC416469	WC 123	T6N	R14E	29
AMC416470	WC 124	T6N	R14E	29
AMC416471	WC 125	T6N	R14E	30, 31
AMC416472	WC 126	T6N	R14E	31
AMC416473	WC 127	T6N	R14E	30, 31
AMC416474	WC 128	T6N	R14E	31
AMC416475	WC 129	T6N	R14E	30, 31
AMC416476	WC 130	T6N	R14E	31
AMC416477	WC 131	T6N	R14E	30, 31
AMC416478	WC 132	T6N	R14E	31
AMC416479	WC 133	T6N	R14E	30, 31
AMC416480	WC 134	T6N	R14E	31
AMC416481	WC 135	T6N	R14E	30, 31
AMC416482	WC 136	T6N	R14E	31
AMC416483	WC 137	T6N	R14E	30, 31
AMC416484	WC 138	T6N	R14E	31
AMC416485	WC 139	T6N	R14E	30, 31
AMC416486	WC 140	T6N	R14E	31
AMC416487	WC 141	T6N	R14E	29, 30, 31, 32
AMC416488	WC 142	T6N	R14E	31, 32
AMC416489	WC 143	T6N	R14E	29, 32
AMC416490	WC 144	T6N	R14E	32
AMC416491	WC 145	T6N	R14E	29, 32
AMC416492	WC 146	T6N	R14E	32
AMC416493	WC 147	T6N	R14E	29, 32
AMC416494	WC 148	T6N	R14E	32
AMC416495	WC 149	T6N	R14E	29, 32
AMC416496	WC 150	T6N	R14E	32
AMC416497	WC 151	T6N	R14E	29, 32
AMC416498	WC 152	T6N	R14E	31, 32
AMC416499	WC 153	T6N	R14E	32
AMC416500	WC 154	T6N	R14E	32
AMC416501	WC 155	T6N	R14E	32
AMC416502	WC 156	T6N	R14E	19



Number of Claims: 735 x \$140.00/claim = \$102,900.00 as maintenance fees for year 2014.

Name and address of Owner or Claimant

Uranium Energy Corp.  
6100 Indian School Road NE  
Suite 225  
Albuquerque, NM 87110  
(505) 830-7707

PROPERTY RECORDS  
COUNTY OF BERNALILLO  
ALBUQUERQUE, NEW MEXICO

**United States Department of the Interior**  
**Bureau of Land Management**  
 LANDS/RECREATION & PLANNING  
 ONE N CENTRAL AVE  
 PHOENIX, AZ 85004 -2203  
 Phone: 602-417-9200

Receipt

No: 2859948

<b>Transaction #:</b> 2945799	
<b>Date of Transaction:</b> 08/20/2013	
CUSTOMER:	
URANIUM ENERGY CORP 6100 INDIAN SCHOOL RD NE SUITE 225 ALBUQUERQUE, NM 87110-4180 US	

LINE #	QTY	DESCRIPTION	REMARKS	UNIT PRICE	TOTAL
1	1.00	LOCATABLE MINERALS / MINING CLAIMS-NOT NEW-UNADJUD, ONE AUTH NO. ONLY / MINING CLAIM MONEY RECEIVED <b>CASES: AMC364029/\$102900.00</b>	MAINT FEE PYMNT (735) 2014	- n/a -	102900.00
<b>TOTAL:</b>					<b>\$102,900.00</b>

PAYMENT INFORMATION			
1	AMOUNT:	102900.00	POSTMARKED: 08/16/2013
	TYPE:	CHECK	RECEIVED: 08/19/2013
	CHECK NO:	15339	
	NAME:	URANIUM ENERGY CORP 1111 W HASTINGS ST STE 320 VANCOUVER BC CANADA NS V6E 2J3 CA	

REMARKS

This receipt was generated by the automated BLM Collections and Billing System and is a paper representation of a portion of the official electronic record contained therein.



Amc 364029  
 Amc 363059  
 Amc 366338  
 Amc 366751  
 Amc 361520  
 Amc 388128  
 Amc 365258  
 Amc 366483  
 Amc 393473  
 Amc 410884  
 CERTIFIED MAIL  
 7196 9000 9408 2463 0572  
 Amc 403601  
 Amc 394954  
 Amc 407697  
 Amc 414006  
 Amc 416412

August 1, 2012

Bureau of Land Management  
 One North Central Avenue, Suite 800  
 Phoenix, Arizona 85004

To Whom It May Concern:

Please find attached our Assessment Fees for our mining claims as defined on the attached affidavit. Also attached is our filing fee of \$102,900.00 check number 12885, and a self-addressed-stamped envelope for your use in returning a copy of our affidavit once recorded by your office.

Please call myself at 505-830-7707 if you have any questions.

Regards,

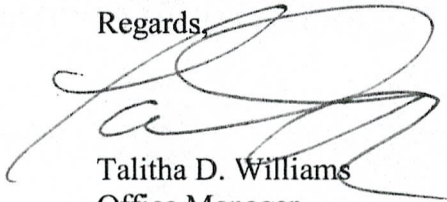

Talitha D. Williams  
 Office Manager

Attachments

NO. OF CLAIMS 735  
 AMOUNT \$102900.00  
 RECEIPT NO. 2624559  
 INIT. AD  
 \*\* BLM-ASO\*\*

RECEIVED  
 BLM AZ STATE OFFICE  
 2012 AUG - 6 P 3:39  
 PHOENIX, ARIZONA

ENTERED IN COMPUTER  
 RE 8.21.12

UNITED STATES DEPARTMENT OF THE INTERIOR  
 BUREAU OF LAND MANAGEMENT  
 DIVISION OF SUPPORT SERVICES  
 ONE NORTH CENTRAL AVENUE, SUITE 800  
 PHOENIX, ARIZONA 85004

July 16, 2012

MAINTENANCE FEES FOR: 2012

RECEIVED  
 BLM AZ STATE OFFICE  
 2012 AUG - 6 P 3: 38  
 PHOENIX, ARIZONA

BLM Serial #	Claim Name	Twp	Rng	Sec
AMC364029	DM 122	8S	28E	29
AMC364030	DM 123	8S	28E	28, 29
AMC364031	DM 124	8S	28E	29
AMC364032	DM 125	8S	28E	28, 29
AMC364033	DM 126	8S	28E	29
AMC364034	DM 127	8S	28E	28, 29
AMC364035	DM 128	8S	28E	29
AMC364036	DM 129	8S	28E	28, 29
AMC364037	DM 130	8S	28E	29
AMC364038	DM 131	8S	28E	28, 29
AMC364039	DM 132	8S	28E	29
AMC364040	DM 133	8S	28E	28, 29
AMC364041	DM 134	8S	28E	29
AMC364042	DM 135	8S	28E	28, 29
AMC364043	DM 164	8S	28E	28
AMC364044	DM 165	8S	28E	28
AMC364045	DM 166	8S	28E	28
AMC364046	DM 167	8S	28E	28
AMC364047	DM 168	8S	28E	28
AMC364048	DM 169	8S	28E	28
AMC364049	DM 170	8S	28E	28
AMC364050	DM 171	8S	28E	28
AMC364051	DM 172	8S	28E	28
AMC364052	DM 173	8S	28E	28
AMC364053	DM 174	8S	28E	28
AMC364054	DM 175	8S	28E	28
AMC364055	DM 176	8S	28E	28
AMC364056	DM 177	8S	28E	28
AMC363059	CG 1	12N	13W	35
AMC363060	CG 2	12N	13W	35
AMC363061	CG 3	12N	13W	35
AMC363062	CG 4	12N	13W	35
AMC363063	CG 5	12N	13W	35

AMC363064	CG 6	12N	13W	35
AMC363065	CG 7	12N	13W	35
AMC363066	CG 8	12N	13W	35
AMC363067	CG 9	12N	13W	35
AMC363068	CG 10	12N	13W	27
AMC363069	CG 11	12N	13W	27
AMC363070	CG 12	12N	13W	27
AMC363071	CG 13	12N	13W	27
AMC363072	CG 14	12N	13W	27
AMC363073	CG 15	12N	13W	27
AMC363074	CG 16	12N	13W	27
AMC363075	CG 17	12N	13W	27
AMC363076	CG 18	12N	13W	27
AMC363077	CG 19	12N	13W	27
<u>AMC366338</u>	CG 20	12N	13W	36
AMC366339	CG 21	12N	13W	36
AMC366340	CG 22	12N	13W	36
AMC366341	CG 23	12N	13W	36
AMC366342	CG 24	12N	13W	36
AMC366343	CG 25	12N	13W	36
AMC366344	CG 26	12N	13W	36
AMC366345	CG 27	12N	13W	36
AMC366346	CG 28	12N	13W	36
AMC366347	CG 29	12N	13W	36
AMC366348	CG 30	12N	13W	36
AMC366349	CG 31	12N	13W	36
AMC366350	CG 32	12N	13W	36
AMC366351	CG 33	12N	13W	36
AMC366352	CG 34	12N	13W	35, 36
AMC366353	CG 35	12N	13W	36
AMC366354	CG 36	12N	13W	36
AMC366355	CG 37	12N	13W	36
AMC366356	CG 38	12N	13W	36
AMC366357	CG 39	12N	13W	36
AMC366358	CG 40	12N	13W	36
AMC366359	CG 41	12N	13W	36
AMC366360	CG 42	12N	13W	36
AMC366361	CG 43	12N	12W	31
AMC366362	CG 44	12N	12W	31
AMC366363	CG 45	12N	13W	35
AMC366364	CG 46	12N	13W	35
AMC366365	CG 47	12N	13W	35
AMC366366	CG 48	12N	13W	35
AMC366367	CG 49	12N	13W	35
<u>AMC366368</u>	CG 50	12N	13W	35
AMC366751	CE 1	11N	10W	11
AMC366752	CE 2	11N	10W	11

RECEIVED  
 RUM AZ STATE OFFICE  
 PHOENIX, ARIZONA  
 2012 AUG - 6 P 3:39

AMC366753	CE 3	11N	10W	11
AMC366754	CE 4	11N	10W	11
AMC366755	CE 5	11N	10W	11
AMC366756	CE 6	11N	10W	11
AMC366757	CE 7	11N	10W	11
AMC366758	CE 8	11N	10W	10
AMC366759	TH 1	11N	10W	10
AMC361520	AM 1	11N	10W	15, 16
AMC361521	AM 2	11N	10W	15
AMC361522	AM 3	11N	10W	15, 16
AMC361523	AM 4	11N	10W	15
AMC361524	AM 5	11N	10W	15, 16
AMC361525	AM 6	11N	10W	15
AMC361526	AM 7	11N	10W	15, 16
AMC361527	AM 8	11N	10W	15, 22
AMC361528	AM 9	11N	10W	15, 16
AMC361529	AM 10	11N	10W	15, 22
AMC361530	AM 11	11N	10W	15, 16, 21, 22
AMC361531	AM 12	11N	10W	22
AMC361532	AM 13	11N	10W	21, 22
AMC361533	AM 14	11N	10W	21, 22
AMC361534	AM 15	11N	10W	21, 22
AMC361535	AM 16	11N	10W	21, 22
AMC361536	AM 17	11N	10W	21
AMC361537	AM 18	11N	10W	21, 22
AMC361538	AM 19	11N	10W	21
AMC361539	AM 20	11N	10W	21, 22
AMC361540	AM 21	11N	10W	21
AMC361541	AM 22	11N	10W	21, 22
AMC361542	AM 23	11N	10W	21
AMC361543	AM 24	11N	10W	21, 22
AMC361544	AM 25	11N	10W	15, 22
AMC361545	AM 26	11N	10W	22
AMC361546	AM 27	11N	10W	22
AMC361547	AM 28	11N	10W	22
AMC361548	AM 29	11N	10W	22
AMC361549	AM 30	11N	10W	22
AMC361550	AM 31	11N	10W	22
AMC361551	AM 32	11N	10W	22
AMC361552	AM 33	11N	10W	22
AMC361553	AM 34	11N	10W	22
AMC361554	AM 35	11N	10W	22
AMC361555	AM 36	11N	10W	22
AMC361556	AM 37	11N	10W	22
AMC361557	AM 38	11N	10W	22
AMC361558	AM 39	11N	10W	22
AMC361559	AM 40	11N	10W	22

RECEIVED  
 PLM AZ STATE OFFICE  
 2012 AUG -6 P 3:38  
 PHOENIX, ARIZONA

AMC361560	AM 41	11N	10W	22
AMC361561	AM 42	11N	10W	22, 27
AMC361562	AM 43	11N	10W	22, 27
AMC361563	AM 44	11N	10W	27
AMC361564	AM 45	11N	10W	27
AMC361565	AM 46	11N	10W	11
AMC361566	AM 47	11N	10W	11
AMC361567	AM 48	11N	10W	11, 14
AMC361568	AM 49	11N	10W	11
AMC361569	AM 50	11N	10W	11, 14
AMC361570	AM 51	11N	10W	11, 14
AMC361571	AM 52	11N	10W	14
AMC361572	AM 53	11N	10W	11, 14
AMC361573	AM 54	11N	10W	14
AMC361574	AM 55	11N	10W	14
AMC361575	AM 56	11N	10W	14
AMC361576	AM 57	11N	10W	14
AMC361577	AM 58	11N	10W	14
AMC361578	AM 59	11N	10W	14
AMC361579	AM 60	11N	10W	14
AMC361580	AM 61	11N	10W	14
AMC361581	AM 62	11N	10W	14
AMC361582	AM 63	11N	10W	14
AMC361583	AM 64	11N	10W	14
AMC361584	AM 65	11N	10W	14
AMC361585	AM 66	11N	10W	14
AMC361586	AM 67	11N	10W	14, 15
AMC361587	AM 68	11N	10W	14, 23
AMC361588	AM 69	11N	10W	14, 15, 23
AMC361589	AM 70	11N	10W	23
AMC361590	AM 71	11N	10W	14, 15, 22, 23
AMC361591	AM 72	11N	10W	23
AMC361592	AM 73	11N	10W	22, 23
AMC361593	AM 74	11N	10W	23
AMC361594	AM 75	11N	10W	22, 23
AMC361595	AM 76	11N	10W	23
AMC361596	AM 77	11N	10W	22, 23
AMC361597	AM 78	11N	10W	23
AMC361598	AM 79	11N	10W	22, 23
AMC361599	AM 80	11N	10W	23
AMC361600	AM 81	11N	10W	22, 23
AMC361601	AM 82	11N	10W	23
AMC361602	AM 83	11N	10W	23
AMC361603	AM 84	11N	10W	23
AMC361604	AM 85	11N	10W	22, 23
AMC361605	AM 86	11N	10W	22, 23, 26, 27
AMC361606	AM 87	11N	10W	22, 27

RECEIVED  
 ELM AZ STATE OFFICE  
 PHOENIX, ARIZONA  
 2012 AUG -6 P 3:39

AMC361607	AM 88	11N	10W	26, 27
AMC361608	AM 89	11N	10W	22, 27
AMC361609	AM 90	11N	10W	26, 27
AMC361610	AM 91	11N	10W	27
AMC361611	AM 92	11N	10W	26, 27
AMC361612	AM 93	11N	10W	27
AMC361613	AM 94	11N	10W	26, 27
AMC361614	AM 95	11N	10W	27
AMC361615	AM 96	11N	10W	26, 27
AMC361616	AM 97	11N	10W	27
AMC361617	AM 98	11N	10W	26, 27
AMC361618	AM 99	11N	10W	27
AMC361619	AM 100	11N	10W	26, 27
AMC361620	AM 101	11N	10W	27
AMC361621	AM 102	11N	10W	26, 27
AMC361622	AM 103	11N	10W	27
AMC361623	AM 104	11N	10W	26, 27, 34
AMC361624	AM 105	11N	10W	11, 12
AMC361625	AM 106	11N	10W	12, 13
AMC361626	AM 107	11N	10W	11, 12, 13, 14
AMC361627	AM 108	11N	10W	12, 13
AMC361628	AM 109	11N	10W	13, 14
AMC361629	AM 110	11N	10W	13
AMC361630	AM 111	11N	10W	13, 14
AMC361631	AM 112	11N	10W	13
AMC361632	AM 113	11N	10W	13, 14
AMC361633	AM 114	11N	10W	13
AMC361634	AM 115	11N	10W	13, 14
AMC361635	AM 116	11N	10W	13, 14
AMC361636	AM 117	11N	10W	14
AMC361637	AM 118	11N	10W	13, 14
AMC361638	AM 119	11N	10W	14
AMC361639	AM 120	11N	10W	14
AMC361640	AM 121	11N	10W	14
AMC361641	AM 122	11N	10W	14
AMC361642	AM 123	11N	10W	14
AMC361643	AM 124	11N	10W	14
AMC361644	AM 125	11N	10W	14
AMC361645	AM 126	11N	10W	14
AMC361646	AM 127	11N	10W	14
AMC361647	AM 128	11N	10W	23, 24
AMC361648	AM 129	11N	10W	23
AMC361649	AM 130	11N	10W	23, 24
AMC361650	AM 131	11N	10W	23
AMC361651	AM 132	11N	10W	23, 24
AMC361652	AM 133	11N	10W	23
AMC361653	AM 134	11N	10W	23

RECEIVED  
 BLH AZ STATE OFFICE  
 PHOENIX, ARIZONA  
 2012 AUG - 6 24  
 14 23  
 14 24  
 23 24



AMC361654	AM 135	11N	10W	23
AMC361655	AM 136	11N	10W	23
AMC361656	AM 137	11N	10W	23
AMC361657	AM 138	11N	10W	23
AMC361658	AM 139	11N	10W	23
AMC361659	AM 140	11N	10W	23
AMC361660	AM 141	11N	10W	23
AMC361661	AM 142	11N	10W	23, 26
AMC361662	AM 143	11N	10W	23, 26
AMC361663	AM 144	11N	10W	23, 26
AMC361664	AM 145	11N	10W	23, 26
AMC361665	AM 146	11N	10W	26
AMC361666	AM 147	11N	10W	26
AMC361667	AM 148	11N	10W	26
AMC361668	AM 149	11N	10W	26
AMC361669	AM 150	11N	10W	26
AMC361670	AM 151	11N	10W	26
AMC361671	AM 152	11N	10W	26
AMC361672	AM 153	11N	10W	26
AMC361673	AM 154	11N	10W	26
AMC361674	AM 155	11N	10W	26
AMC361675	AM 156	11N	10W	26
AMC361676	AM 157	11N	10W	26
AMC361677	AM 158	11N	10W	26
AMC361678	AM 159	11N	10W	26
AMC361679	AM 160	11N	10W	26, 35
AMC361680	AM 161	11N	10W	26, 35
AMC361681	AM 162	11N	10W	26, 35
AMC361682	AM 163	11N	10W	12, 13
AMC361683	AM 164	11N	10W	13
AMC361684	AM 165	11N	10W	13
AMC361685	AM 166	11N	10W	13
AMC361686	AM 167	11N	10W	13
AMC361687	AM 168	11N	10W	13
AMC361688	AM 169	11N	10W	13
AMC361689	AM 170	11N	10W	13
AMC361690	AM 171	11N	10W	13
AMC361691	AM 172	11N	10W	13
AMC361692	AM 173	11N	10W	13
AMC361693	AM 174	11N	10W	13
AMC361694	AM 175	11N	10W	13
AMC361695	AM 176	11N	10W	13
AMC361696	AM 177	11N	10W	13
AMC361697	AM 178	11N	10W	13
AMC361698	AM 179	11N	10W	13
AMC361699	AM 180	11N	10W	13, 24
AMC361700	AM 181	11N	10W	13, 24

RECEIVED  
 BLM AZ STATE OFFICE  
 PHOENIX, ARIZONA  
 2012 AUG -6 P 3:40

AMC361701	AM 182	11N	10W	24
AMC361702	AM 183	11N	10W	24
AMC361703	AM 184	11N	10W	24
AMC361704	AM 185	11N	10W	24
AMC361705	AM 186	11N	10W	24
AMC361706	AM 187	11N	10W	24
AMC361707	AM 188	11N	10W	24
AMC361708	AM 189	11N	10W	24
AMC361709	AM 190	11N	10W	24
AMC361710	AM 191	11N	10W	23, 24
AMC361711	AM 192	11N	10W	24
AMC361712	AM 193	11N	10W	23, 24
AMC361713	AM 194	11N	10W	24
AMC361714	AM 195	11N	10W	23, 24
AMC361715	AM 196	11N	10W	24
AMC361716	AM 197	11N	10W	23, 24
AMC361717	AM 198	11N	10W	24, 25
AMC361718	AM 199	11N	10W	23, 24, 25, 26
AMC361719	AM 200	11N	10W	24, 25
AMC361720	AM 201	11N	10W	25, 26
AMC361721	AM 202	11N	10W	25
AMC361722	AM 203	11N	10W	25, 26
AMC361723	AM 204	11N	10W	25
AMC361724	AM 205	11N	10W	25, 26
AMC361725	AM 206	11N	10W	25
AMC361726	AM 207	11N	10W	25, 26
AMC361727	AM 208	11N	10W	25
AMC361728	AM 209	11N	10W	25, 26
AMC361729	AM 210	11N	10W	25, 26
AMC361730	AM 211	11N	10W	25, 26
AMC361731	AM 212	11N	10W	25, 26
AMC361732	AM 213	11N	10W	25, 26
AMC361733	AM 214	11N	10W	25, 26
AMC361734	AM 215	11N	10W	25, 26
<u>AMC361735</u>	AM 216	11N	10W	25, 26
AMC388128	AM 217	11N	10W	26
AMC388129	AM 218	11N	10W	26
AMC388130	AM 219	11N	10W	26
AMC388131	AM 220	11N	10W	26
AMC388132	AM 221	11N	10W	26
AMC388133	AM 222	11N	10W	26
AMC388134	AM 223	11N	10W	26
AMC388135	AM 224	11N	10W	26
AMC388136	AM 225	11N	10W	26
AMC388137	AM 226	11N	10W	26
AMC388138	AM 227	11N	10W	26
AMC388139	AM 228	11N	10W	26

RECEIVED  
 BLM AZ STATE OFFICE  
 PHOENIX, ARIZONA  
 2012 AUG 26 9:10 AM  
 3

AMC388140	AM 229	11N	10W	3
AMC388141	AM 230	11N	10W	3
AMC388142	AM 231	11N	10W	10, 11
AMC388143	AM 232	11N	10W	11
AMC388144	AM 233	11N	10W	10, 11
AMC388145	AM 234	11N	10W	11
AMC388146	AM 235	11N	10W	2, 3, 10, 11
AMC388147	AM 236	11N	10W	11
AMC388148	AM 237	11N	10W	2, 3, 11
AMC388149	AM 238	11N	10W	2, 11
AMC388150	AM 239	11N	10W	11
AMC388151	AM 240	11N	10W	11
AMC388152	AM 241	11N	10W	11
AMC388153	AM 242	11N	10W	11
AMC388154	AM 243	11N	10W	11
AMC388155	AM 244	11N	10W	11
<del>AMC388156</del>	AM 245	11N	10W	11
AMC361736	AM 246	11N	10W	10
AMC361737	AM 247	11N	10W	10
AMC361738	AM 248	11N	10W	10, 11
AMC361739	AM 249	11N	10W	11
AMC361740	AM 250	11N	10W	11
AMC361741	AM 251	11N	10W	11
AMC361742	AM 252	11N	10W	11
AMC361743	AM 253	11N	10W	11
AMC361744	AM 254	11N	10W	9, 15, 16
AMC361745	AM 255	11N	10W	9, 16
AMC361746	AM 256	11N	10W	9, 10, 15
AMC361747	AM 257	11N	10W	9
AMC361748	AM 258	11N	10W	9, 10
AMC361749	AM 259	11N	10W	9
AMC361750	AM 260	11N	10W	9, 10
AMC361751	AM 261	11N	10W	9
AMC361752	AM 262	11N	10W	9, 10
AMC361753	AM 263	11N	10W	9
<del>AMC361754</del>	AM 264	11N	10W	27, 34
AMC365258	AM 265	11N	10W	10, 11
AMC365259	AM 266	11N	10W	11
AMC365260	AM 267	11N	10W	10, 11
AMC365261	AM 268	11N	10W	10, 11
AMC365262	AM 269	11N	10W	10, 11
AMC365263	AM 270	11N	10W	10, 11
AMC365264	AM 271	11N	10W	10, 11, 15
AMC365265	AM 272	11N	10W	10, 11, 14, 15
AMC365266	AM 273	11N	10W	10, 15
AMC365267	AM 274	11N	10W	14, 15
AMC365268	AM 275	11N	10W	15

RECEIVED  
 BLM AZ STATE OFFICE  
 2012 AUG 16 P 3:40  
 PHOENIX, ARIZONA

AMC365269	AM 276	11N	10W	14, 15
AMC365270	AM 277	11N	10W	15
AMC365271	AM 278	11N	10W	14, 15
AMC365272	AM 279	11N	10W	15
AMC365273	AM 280	11N	10W	14, 15
AMC365274	AM 281	11N	10W	15
AMC365275	AM 282	11N	10W	14, 15
AMC365276	AM 283	11N	10W	15
AMC365277	AM 284	11N	10W	14, 15
AMC365278	AM 285	11N	10W	15
AMC365279	AM 286	11N	10W	14, 15
AMC365280	AM 287	11N	10W	10
AMC365281	AM 288	11N	10W	10
AMC365282	AM 289	11N	10W	10
AMC365283	AM 290	11N	10W	10
AMC365284	AM 291	11N	10W	10
AMC365285	AM 292	11N	10W	10
AMC365286	AM 293	11N	10W	10
AMC365287	AM 294	11N	10W	10
AMC365288	AM 295	11N	10W	10
AMC365289	AM 296	11N	10W	15
AMC365290	AM 297	11N	10W	15, 16
AMC365291	AM 298	11N	10W	15
AMC365292	AM 299	11N	10W	15, 16
AMC365293	AM 300	11N	10W	15
AMC365294	AM 301	11N	10W	15
AMC366483	AM 302	11N	10W	9, 10
AMC366484	AM 303	11N	10W	10
AMC366485	AM 304	11N	10W	10
AMC366486	AM 305	11N	10W	10
AMC366487	AM 306	11N	10W	10
AMC366488	AM 307	11N	10W	10
AMC366489	AM 308	11N	10W	10, 11
AMC366490	AM 309	11N	10W	11
AMC388157	AM 310	11N	10W	11, 12
AMC388158	AM 311	11N	10W	2, 11
AMC388159	AM 312	11N	10W	2, 11, 12
AMC388160	AM 313	11N	10W	1, 2, 11, 12
AMC388161	AM 314	11N	10W	12
AMC388162	AM 315	11N	10W	12
AMC388163	AM 316	11N	10W	12
AMC388164	AM 317	11N	10W	11, 12
AMC388165	AM 318	11N	10W	12
AMC388166	AM 319	11N	10W	11, 12
AMC388167	AM 320	11N	10W	12
AMC388168	AM 321	11N	10W	11, 12
AMC388169	AM 322	11N	10W	12

PHOENIX, ARIZONA

2017 AUG 10 10:53:40

RECEIVED  
BLM AZ STATE OFFICE

AMC388170	AM 323	11N	10W	11, 12
AMC388171	AM 324	11N	10W	12
AMC388172	AM 325	11N	10W	13
AMC388173	AM 326	11N	10W	13
AMC388174	AM 327	11N	9W/10W	18/13
AMC388175	AM 328	11N	9W/10W	18, 19/13, 24
AMC388176	AM 329	11N	9W	18, 19
AMC388177	AM 330	11N	10W	13, 24
AMC388178	AM 331	11N	9W/10W	19/ 24
AMC388179	AM 332	11N	10W	24
AMC388180	AM 333	11N	9W/10W	19/ 24
AMC388181	AM 334	11N	10W	24
AMC388182	AM 335	11N	9W/10W	19/ 24
AMC388183	AM 336	11N	10W	24
AMC388184	AM 337	11N	9W/10W	19/ 24
AMC388185	AM 338	11N	10W	24
AMC388186	AM 339	11N	9W/10W	19/ 24
AMC388187	AM 340	11N	10W	24
AMC388188	AM 341	11N	9W/10W	19/ 24
AMC388189	AM 342	11N	10W	24
AMC388190	AM 343	11N	9W/10W	19/ 24
AMC388191	AM 344	11N	10W	24
AMC388192	AM 345	11N	9W/10W	19/ 24
AMC388193	AM 346	11N	10W	24, 25
AMC388194	AM 347	11N	9W/10W	19, 30/24, 25
AMC388195	AM 348	11N	10W	24, 25
AMC388196	AM 349	11N	10W	25
AMC388197	AM 350	11N	10W	25
AMC388198	AM 351	11N	10W	25
AMC388199	AM 352	11N	10W	25
AMC388200	AM 353	11N	10W	25
AMC388201	AM 354	11N	10W	25
AMC388202	AM 355	11N	10W	25
AMC388203	AM 356	11N	10W	25
<u>AMC388204</u>	AM 357	11N	10W	25
AMC393473	AM 358	11N	10W	21
AMC393474	AM 359	11N	10W	21
AMC393475	AM 360	11N	10W	21
<u>AMC393476</u>	AM 361	11N	10W	21
AMC410892	AP 9	11N	10W	9
AMC410893	AP 10	11N	10W	9
AMC410894	AP 11	11N	10W	9
AMC410895	AP 12	11N	10W	9
AMC410896	AP 13	11N	10W	9
AMC410897	AP 14	11N	10W	9
AMC410898	AP 15	11N	10W	9
AMC410899	AP 16	11N	10W	9

RECEIVED  
 BLM AZ STATE OFFICE  
 2012 AUG -6 P 3:40  
 PHOENIX, ARIZONA

AMC410900	AP 17	11N	10W	9, 16
AMC410901	AP 18	11N	10W	9, 16
<del>AMC410905</del>	AP 22	11N	10W	9, 10
<del>AMC410907</del>	AP 24	11N	10W	9, 10
AMC410909	AP 26	11N	10W	9, 10
AMC410910	AP 27	11N	10W	9
AMC410911	AP 28	11N	10W	9, 10
AMC410913	AP 30	11N	10W	10
AMC410914	AP 31	11N	10W	1, 2, 11, 12
AMC410915	AP 32	11N	10W	1
AMC410916	AP 33	11N	10W	12
AMC410917	AP 34	11N	10W	12
AMC410918	AP 35	11N	10W	12
AMC410919	AP 36	11N	10W	12
AMC410920	AP 37	11N	10W	1, 12
AMC410922	AP 39	11N	10W	12
AMC410923	AP 40	11N	9W	7, 12
AMC410924	AP 41	11N	10W	12
AMC410925	AP 42	11N	9W	7, 12
AMC410926	AP 43	11N	10W	12
AMC410927	AP 44	11N	9W	7, 12
AMC410928	AP 45	11N	10W	12
AMC410929	AP 46	11N	9W	7, 12
AMC410930	AP 47	11N	10W	12
AMC410931	AP 48	11N	9W	7, 12
AMC410932	AP 49	11N	10W	12
AMC410933	AP 50	11N	9W	7, 12
AMC410934	AP 51	11N	10W	12
AMC410935	AP 52	11N	9W	7, 12
AMC410936	AP 53	11N	10W	13, 12
AMC410937	AP 54	11N	9W/10W	7, 18/13, 12
AMC410938	AP 55	11N	9W/10W	18/13
AMC410939	AP 56	11N	9W/10W	18/13
AMC410940	AP 57	11N	9W/10W	18/13
AMC410941	AP 58	11N	10W	25
AMC410942	AP 59	11N	10W	25
AMC410943	AP 60	11N	10W	25
AMC410944	AP 61	11N	10W	25
AMC410945	AP 62	11N	10W	25
AMC410946	AP 63	11N	10W	25
AMC410947	AP 64	11N	10W	25
AMC410948	AP 65	11N	10W	25
AMC410949	AP 66	11N	10W	25
AMC410950	AP 67	11N	10W	25
AMC410951	AP 68	11N	10W	25
AMC410952	AP 69	11N	10W	25
AMC410953	AP 70	11N	10W	25

RECEIVED  
 PLM AZ STATE OFFICE  
 2012 AUG -6 P 3:49  
 PHOENIX, ARIZONA

AMC410954	AP 71	11N	10W	25
AMC410955	AP 72	11N	10W	25
AMC410956	AP 73	11N	10W	25
AMC410957	AP 74	11N	10W	16, 17, 20, 21
AMC410958	AP 75	11N	10W	20, 21
AMC410959	AP 76	11N	10W	20, 21
AMC410960	AP 77	11N	10W	21
AMC410961	AP 78	11N	10W	20, 21
AMC410962	AP 79	11N	10W	21
AMC410963	AP 80	11N	10W	20, 21
AMC410964	AP 81	11N	10W	21
AMC410965	AP 82	11N	10W	20, 21
AMC410966	AP 83	11N	10W	21
AMC410967	AP 84	11N	10W	20, 21
AMC410968	AP 85	11N	10W	21
AMC410969	AP 86	11N	10W	20, 21
AMC410970	AP 87	11N	10W	21
AMC410971	AP 88	11N	10W	20, 21, 28, 29
AMC410972	AP 89	11N	10W	21, 28
AMC410973	AP 90	11N	10W	21
AMC410974	AP 91	11N	10W	21
AMC410975	AP 92	11N	10W	21
AMC410976	AP 93	11N	10W	21, 22
AMC410977	AP 94	11N	10W	21
AMC410978	AP 95	11N	10W	21, 22
AMC410979	AP 96	11N	10W	21
AMC410980	AP 97	11N	10W	21, 22
AMC410981	AP 98	11N	10W	21
AMC410982	AP 99	11N	10W	21, 22
AMC410983	AP 100	11N	10W	21, 28
AMC410984	AP 101	11N	10W	21, 22, 27, 28
AMC410985	AP 102	11N	10W	22
AMC410986	AP 103	11N	10W	13, 18
AMC410987	AP 104	11N	10W	13, 18
<u>AMC403611</u>	Oak 1	5N	14E	28
AMC403612	Oak 2	5N	14E	28
AMC403613	Oak 3	5N	14E	28
AMC403614	Oak 4	5N	14E	27
AMC403615	Oak 5	5N	14E	27
AMC403616	Oak 6	5N	14E	27
AMC403617	Oak 7	5N	14E	27
AMC403618	Oak 8	5N	14E	27
AMC403619	Oak 9	5N	14E	27
<u>AMC403620</u>	Oak 10	5N	14E	27
AMC403601	Bak 1	6N	14E	20
AMC403602	Bak 2	6N	14E	20
AMC403603	Bak 3	6N	14E	20

RECEIVED  
 P.L.M. AZ STATE OFFICE  
 PHOENIX, ARIZONA

AMC403604	Bak 4	6N	14E	20
AMC403605	Bak 5	6N	14E	20
AMC403606	Bak 6	6N	14E	29
AMC403607	Bak 7	6N	14E	29
AMC403608	Bak 8	6N	14E	29
AMC403609	Bak 9	6N	14E	29
AMC403610	Bak 10	6N	14E	20
AMC394981	RC 10	6N	14E	17
AMC394982	RC 11	6N	14E	17
AMC394983	RC 12	6N	14E	17
AMC394984	RC 13	6N	14E	17
AMC394985	RC 14	6N	14E	17
AMC394986	RC 15	6N	14E	17
AMC394987	RC 16	6N	14E	17
AMC394988	RC 17	6N	14E	17
AMC394989	RC 18	6N	14E	17
AMC394990	RC 19	6N	14E	17
AMC394991	RC 20	6N	14E	17
AMC394992	RC 21	6N	14E	17
AMC394993	RC 22	6N	14E	17
AMC394994	RC 23	6N	14E	17
AMC394995	RC 24	6N	14E	17
AMC403621	Pen 1	7N	14E	2, 11
AMC403622	Pen 2	7N	14E	2, 1, 11, 12
AMC403623	Pen 3	7N	14E	1, 12
AMC403624	Pen 4	7N	14E	1, 12
AMC403625	Pen 5	7N	14E	1, 12
AMC403626	Pen 6	7N	14E	1, 12
AMC403627	Pen 7	7N	14E	1, 12
AMC403628	Pen 9	7N	14E	1, 12
AMC403629	Pen 10	7N	14E	12
AMC403630	Pen 11	7N	14E	12
AMC403631	Pen 12	7N	14E	12
AMC403632	Pen 13	7N	14E	12
AMC403633	Pen 14	7N	14E	12
AMC403634	Pen 15	7N	14E	12
AMC403635	Pen 16	7N	14E	11, 12
AMC403636	Pen 17	7N	14E	12
AMC403637	Pen 18	7N	14E	12
AMC403638	Pen 19	7N	14E	12
AMC403639	Pen 20	7N	14E	12
AMC403640	Pen 21	7N	14E	12
AMC403641	Pen 22	7N	14E	12
AMC403642	Pen 23	7N	14E	12
AMC403643	Pen 24	7N	14E	12
AMC403644	Pen 25	7N	14E	12
AMC403645	Pen 26	7N	14E	12

RECEIVED  
 GIM AZ STATE OFFICE  
 PHOENIX, ARIZONA  
 2012 AUG -6 P 3:40



AMC403646	Pen 27	7N	14E	12
AMC403647	Pen 28	7N	14E	12
AMC403648	Pen 29	7N	14E	12
AMC403649	Pen 30	7N	14E	11, 12
AMC403650	Pen 31	7N	14E	11
AMC403651	Pen 32	7N	14E	11, 14
AMC403652	Pen 33	7N	14E	11, 14, 12, 13
AMC403653	Pen 34	7N	14E	12, 13
AMC403654	Pen 35	7N	14E	12, 13
AMC403655	Pen 36	7N	14E	12, 13
AMC403656	Pen 37	7N	14E	12, 13
<u>AMC403657</u>	Pen 38	7N	14E	12, 13
AMC407697	CS 1	6N	14E	19
AMC407698	CS 2	6N	14E	19
AMC407699	CS 3	6N	14E	19
AMC407700	CS 4	6N	14E	19, 20
AMC407701	CS 5	6N	14E	19
AMC407702	CS 6	6N	14E	19
AMC407703	CS 7	6N	14E	19
AMC407704	CS 8	6N	14E	19
AMC407705	CS 9	6N	14E	19
AMC407706	CS 10	6N	14E	19
AMC407707	CS 11	6N	14E	19
AMC407708	CS 12	6N	14E	19
AMC407709	CS 13	6N	14E	19, 20
AMC407710	CS 14	6N	14E	19
AMC407711	CS 15	6N	14E	19
AMC407712	CS 16	6N	14E	19
AMC407713	CS 17	6N	14E	19
AMC407714	CS 18	6N	14E	19
AMC407715	CS 19	6N	14E	19, 20
AMC407716	CS 20	6N	14E	20
AMC407717	CS 21	6N	14E	20
AMC407718	CS 22	6N	14E	20
AMC407719	CS 23	6N	14E	20
AMC407720	CS 24	6N	14E	20, 29
AMC407721	CS 25	6N	14E	20, 29
AMC407722	CS 26	6N	14E	20, 29
AMC407723	CS 27	6N	14E	18
AMC407724	CS 28	6N	14E	18
AMC407725	CS 29	6N	14E	18
AMC407726	CS 30	6N	14E	18
<u>AMC407727</u>	CS 31	6N	14E	19
AMC414006	WC 62	6N	14E	18, 19
AMC414007	WC 63	6N	14E	19
AMC414008	WC 64	6N	14E	19
<u>AMC414009</u>	WC 65	6N	14E	19, 20, 29

PHOENIX, ARIZONA

RECEIVED  
FLM AZ STATE OFFICE  
JUN 20 10 20 AM '99

AMC416412	WC 66	T6N	R14E	18, 19
AMC416413	WC 67	T6N	R14E	18, 19
AMC416414	WC 68	T6N	R14E	18, 19
AMC416415	WC 69	T6N	R13E	24
AMC416416	WC 70	T6N	R13E	24
AMC416417	WC 71	T6N	R13/14E	24/19
AMC416418	WC 72	T6N	R13/14E	24/19
AMC416419	WC 73	T6N	R14E	19
AMC416420	WC 74	T6N	R14E	19
AMC416421	WC 75	T6N	R14E	19
AMC416422	WC 76	T6N	R14E	19
AMC416423	WC 77	T6N	R14E	19
AMC416424	WC 78	T6N	R14E	19
AMC416425	WC 79	T6N	R14E	19
AMC416426	WC 80	T6N	R14E	19
AMC416427	WC 81	T6N	R14E	19
AMC416428	WC 82	T6N	R14E	19
AMC416429	WC 83	T6N	R14E	19, 30
AMC416430	WC 84	T6N	R14E	19
AMC416431	WC 85	T6N	R14E	19, 30
AMC416432	WC 86	T6N	R14E	19
AMC416433	WC 87	T6N	R14E	19, 30
AMC416434	WC 88	T6N	R14E	19
AMC416435	WC 89	T6N	R14E	19, 30
AMC416436	WC 90	T6N	R14E	19
AMC416437	WC 91	T6N	R14E	19, 30
AMC416438	WC 92	T6N	R14E	19, 30
AMC416439	WC 93	T6N	R14E	19, 30
AMC416440	WC 94	T6N	R14E	19, 30
AMC416441	WC 95	T6N	R14E	19, 30
AMC416442	WC 96	T6N	R13/14E	19, 20, 29, 30
AMC416443	WC 97	T6N	R14E	25/30
AMC416444	WC 98	T6N	R14E	25/30
AMC416445	WC 99	T6N	R14E	30
AMC416446	WC 100	T6N	R14E	30
AMC416447	WC 101	T6N	R14E	30
AMC416448	WC 102	T6N	R14E	30
AMC416449	WC 103	T6N	R14E	30
AMC416450	WC 104	T6N	R14E	30
AMC416451	WC 105	T6N	R14E	30
AMC416452	WC 106	T6N	R14E	30
AMC416453	WC 107	T6N	R14E	30
AMC416454	WC 108	T6N	R14E	30
AMC416455	WC 109	T6N	R14E	30
AMC416456	WC 110	T6N	R14E	30
AMC416457	WC 111	T6N	R14E	30
AMC416458	WC 112	T6N	R14E	30

RECEIVED  
 BLM AZ STATE OFFICE  
 PHOENIX, ARIZONA  
 2017 AUG -5 P 3:49



Number of Claims: 735 x \$140.00/claim = \$102,900.00 as maintenance fees for year 2013.

Name and address of Owner or Claimant

Uranium Energy Corp.  
6100 Indian School Road NE  
Suite 225  
Albuquerque, NM 87110  
(505) 830-7707

RECEIVED  
BLM AZ STATE OFFICE  
2012 AUG - 6 P 3:40  
PHOENIX, ARIZONA

RECEIVED  
BLM AZ STATE OFFICE  
2012 AUG -6 P 3 39  
PHOENIX, ARIZONA

Sender:

7196 9000 9408 2463 0572  
CERTIFIED MAIL

stamps  
.com

\* Barcode 5,273,277 \*  
\* 5,007,648 \* 2,868,889 \*  
\* 1,177 Laser Form \*  
\* USPS CM-138 12/11 \*

\$6.80  
US POSTAGE  
FIRST-CLASS  
FROM 87110  
AUG 01 2012  
stamps  
.com



Bureau Land Management  
1 North Central Ave Suite 800  
Phoenix AZ 85004-4427

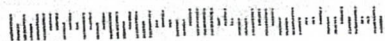

RECEIVED  
BLM AZ STATE OFFICE

2012 AUG -6 P 3 39

PHOENIX, ARIZONA

Sender:

7195 8000 9408 2463 0572  
CERTIFIED MAIL

stamps  
.com

\* Postage 5.078 271\*  
\* 5007 1000 500000\*  
\* USPS CMS-134 12011\*

\$6.80  
US POSTAGE  
FIRST-CLASS  
FROM 87110  
AUG 01 2012  
stamps  
.com



06250006358255

Bureau Land Management  
1 North Central Ave Suite 800  
Phoenix AZ 85004-4427

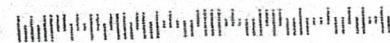

Receipt

**United States Department of the Interior**  
**Bureau of Land Management**  
 LANDS/RECREATION & PLANNING  
 ONE N CENTRAL AVE  
 PHOENIX, AZ 85004 -2203  
 Phone: 602-417-9200

Receipt

No: 2624559

<b>Transaction #:</b> 2704957	
<b>Date of Transaction:</b> 08/07/2012	
<b>CUSTOMER:</b>	
URANIUM ENERGY CORP 6100 INDIAN SCHOOL RD NE SUITE 225 ALBUQUERQUE, NM 87110-4180 US	

LINE #	QTY	DESCRIPTION	REMARKS	UNIT PRICE	TOTAL
1	1.00	LOCATABLE MINERALS / MINING CLAIMS-NOT NEW-UNADJUD, ONE AUTH NO. ONLY / MINING CLAIM MONEY RECEIVED <b>CASES: AMC364029/\$102900.00</b>	MAINT FEE PYMNT (735) 2013	- n/a -	102900.00
<b>TOTAL:</b>					<b>\$102,900.00</b>

PAYMENT INFORMATION			
1	AMOUNT:	102900.00	POSTMARKED: N/A
	TYPE:	CHECK	RECEIVED: 08/06/2012
	CHECK NO:	12885	
	NAME:	URANIUM ENERGY CORP 1111 W HASTINGS ST STE 320 VANCOUVER BC CANADA NS V6E 2J3	

REMARKS

This receipt was generated by the automated BLM Collections and Billing System and is a paper representation of a portion of the official electronic record contained therein.



Amc 364029  
Amc 363059  
Amc 366338  
Amc 366751  
Amc 361520  
Amc 388128  
Amc 365258  
Amc 366483  
Amc 393473

August 22, 2011

CERTIFIED MAIL  
7196 9008 7300 9933 0572

Bureau of Land Management  
Arizona State Office  
Business & Support Services Division  
222 N. Central Ave  
Phoenix, AZ 84004-2203

To Whom It May Concern:

Please find attached our Assessment Fees for our mining claims as defined on the attached affidavit. Also attached is our filing fee of \$62,720.00 check number 10544, and a self-addressed-stamped envelope for your use in returning a copy of our affidavit once recorded by your office.

Please call myself at 505-830-7707 if you have any questions.

Regards,

Kathleen M. Webb  
Office Manager

Attachments

RECEIVED  
BLM AZ STATE OFFICE  
2011 AUG 25 P 3:06  
PHOENIX, ARIZONA



UNITED STATES DEPARTMENT OF THE INTERIOR  
 BUREAU OF LAND MANAGEMENT  
 ARIZONA STATE OFFICE  
 BUSINESS & SUPPORT SERVICES DIVISION  
 222 N. CENTRAL AVENUE  
 PHOENIX, AZ 85004-2203

August 22, 2011

MAINTENANCE FEES FOR: 2012

<u>Name of claim(s)</u>	<u>BLM Serial No(s)</u>
<u>DM #122 through #135</u>	<u>AMC364029-364042</u> 14
<u>DM #164 through #177</u>	<u>AMC364043-364056</u> 14
<u>CG #1 through #19</u>	<u>AMC363059-363077</u> 19
<u>CG #20 through #50</u>	<u>AMC366338-366368</u> 31
<u>CE #1 through #9</u>	<u>AMC366751-366759</u> 9
<u>AM #1 through #216</u>	<u>AMC361520-361735</u> 216
<u>AM #217 through #245</u>	<u>AMC388138-388156</u> 19
<u>AM #246 through #264</u>	<u>AMC361736-361754</u> 19
<u>AM #265 through #301</u>	<u>AMC365258-365294</u> 37
<u>AM #302 through #309</u>	<u>AMC366483-366490</u> 8
<u>AM #310 through #357</u>	<u>AMC388157-388204</u> 48
<u>AM #358 through #361</u>	<u>AMC393473-393476</u> 4
	<u>438</u>

Number of Claims: 448 x \$140.00/claim = \$62,720.00 as maintenance fee for year 2012.

Name and address of  
 Owner or Claimant

Uranium Energy Corp.  
6100 Indian School Road NE  
Suite 225  
Albuquerque, NM 87110  
(505) 830-7707

RECEIVED  
 BLM ARIZONA STATE OFFICE  
 2011 AUG 25 P 3:06  
 PHOENIX, ARIZONA

NO. OF CLAIMS 448  
 AMOUNT 62720.00  
 RECEIPT NO. 2415702  
 INIT. ERG

\*\* BLM-ASO\*\*

CHK# 122547



**URANIUM ENERGY CORP**  
 1111 W HASTINGS ST., STE. 320  
 VANCOUVER, BC V6E 2J8  
 CANADA

WELLS FARGO BANK, N.A.  
 www.wellsfargo.com  
 19-854/1250

10544

PAY TO THE  
 ORDER OF

\*\*\*\*\*Sixty-Two Thousand Seven Hundred Twenty and 00/100

DATE 08152011  
 M M D D Y Y Y Y

\$ \*\* 62,720.00

Bureau of Land Management

DOLLARS

MEMO

Check#10417 Reissue

*[Handwritten Signature]*  
 AUTHORIZED SIGNATURE

⑈0000010544⑈ ⑆125008547⑆ 7757033142⑈

URANIUM ENERGY CORP  
 Bureau of Land Management

8/15/2011

10544

Date	Type	Reference
08/15/2011	Bill	Check#10417 Reissue

Original Amt.  
 62,720.00

Balance Due	Discount
62,720.00	
Cheque Amount	

Payment
USD 62,720.00
USD 62,720.00

CA Wells Fargo-WA Check#10417 Reissue

USD 62,720.00

RECEIVED  
 CLIMATE STATE OFFICE  
 2011 AUG 25 P 3:06  
 PHOENIX, ARIZONA

Details on Back  
 Security Features Included

**United States Department of the Interior**  
**Bureau of Land Management**  
 LANDS/RECREATION & PLANNING  
 ONE N CENTRAL AVE  
 PHOENIX, AZ 85004 -2203  
 Phone: 602-417-9200

Receipt

No: 2415702

<b>Transaction #:</b> 2491073	
<b>Date of Transaction:</b> 08/25/2011	
CUSTOMER:	
URANIUM ENERGY CORP 6100 INDIAN SCHOOL RD NE STE 2 ALBUQUERQUE, NM 87110-4181 US	

LINE #	QTY	DESCRIPTION	REMARKS	UNIT PRICE	TOTAL
1	1.00	LOCATABLE MINERALS / MINING CLAIMS- NOT NEW-UNADJUD, ONE AUTH NO. ONLY / MINING CLAIM MONEY RECEIVED CASES: AMC364029/\$62720.00	2012 MAINT (448)	- n/a -	62720.00
<b>TOTAL:</b>					<b>\$62,720.00</b>

PAYMENT INFORMATION			
1	AMOUNT:	62720.00	POSTMARKED: N/A
	TYPE:	CHECK	RECEIVED: 08/25/2011
	CHECK NO:	122547	
	NAME:	LEWIS AND ROCA LLP 40 N CENTRAL AVE PHOENIX AZ 85004-4429 US	

REMARKS

This receipt was generated by the automated BLM Collections and Billing System and is a paper representation of a portion of the official electronic record contained therein.



**GLOBAL URANIUM CORP.**

POWER FOR THE NEW MILLENNIUM

TEX V 60

AMC 361520  
AMC 365258  
AMC 366483  
AMC 366751

10 August 2010

HAND-DELIVERED

US Dept. of the Interior  
Bureau of Land Management  
Arizona State Office

Dear Sirs:

Global Uranium Corporation, on behalf of the owners of the claims, Concentric Energy Corp., is enclosing a (HSBC) bank draft in the amount of USD 39,200.00 to cover the annual maintenance fees for the 2010 – 2011 assessment year for the claims in the attached list. It is the intention of the owner to hold said claims for the 2010 – 2011 assessment year ending noon September 01, 2011.

Thank you.

Yours truly,  
GLOBAL URANIUM CORPORATION

George W. Heard  
President  
/encl.

RECEIVED  
BLM ARIZONA STATE OFFICE  
2010 AUG 10 P 12:34  
PHOENIX, ARIZONA

NO. OF CLAIMS 289  
AMOUNT 40,460.00  
RECEIPT NO. 2187630  
INIT. SC

\*\* BLM-ASO\*\*

## Anderson Mine Claims, Yavapai County, Arizona

Claim Name	BLM Serial Number	Yavapai County Book	Page
AM 1	AMC 361520	4152	183
AM 2	AMC 361521	4152	184
AM 3	AMC 361522	4152	185
AM 4	AMC 361523	4152	186
AM 5	AMC 361524	4152	187
AM 6	AMC 361525	4152	188
AM 7	AMC 361526	4152	189
AM 8	AMC 361527	4152	190
AM 9	AMC 361528	4152	191
AM 10	AMC 361529	4152	192
AM 11	AMC 361530	4152	193
AM 12	AMC 361531	4152	194
AM 13	AMC 361532	4152	195
AM 14	AMC 361533	4152	196
AM 15	AMC 361534	4152	197
AM 16	AMC 361535	4152	198
AM 17	AMC 361536	4152	199
AM 18	AMC 361537	4152	200
AM 19	AMC 361538	4152	201
AM 20	AMC 361539	4152	202
AM 21	AMC 361540	4152	203
AM 22	AMC 361541	4152	204
AM 23	AMC 361542	4152	205
AM 24	AMC 361543	4152	206
AM 25	AMC 361544	4152	207
AM 26	AMC 361545	4152	208
AM 27	AMC 361546	4152	209
AM 28	AMC 361547	4152	210
AM 29	AMC 361548	4152	211
AM 30	AMC 361549	4152	212
AM 31	AMC 361550	4152	213
AM 32	AMC 361551	4152	214
AM 33	AMC 361552	4152	215
AM 34	AMC 361553	4152	216
AM 35	AMC 361554	4152	217
AM 36	AMC 361555	4152	218
AM 37	AMC 361556	4152	219
AM 38	AMC 361557	4152	220
AM 39	AMC 361558	4152	221
AM 40	AMC 361559	4152	222
AM 41	AMC 361560	4152	223
AM 42	AMC 361561	4152	224
AM 43	AMC 361562	4152	225
AM 44	AMC 361563	4152	226
AM 45	AMC 361564	4152	227
AM 46	AMC 361565	4152	228
AM 47	AMC 361566	4152	229

PHOENIX, ARIZONA

2010 AUG 10 P 12: 34

RECEIVED  
BLM AZ STATE OFFICE

47/50

### Anderson Mine Claims, Yavapai County, Arizona

Claim Name	BLM Serial Number	Yavapai County Book	Page
AM 48	AMC 361567	4152	230
AM 49	AMC 361568	4152	231
AM 50	AMC 361569	4152	232
AM 51	AMC 361570	4152	233
AM 52	AMC 361571	4152	234
AM 53	AMC 361572	4152	235
AM 54	AMC 361573	4152	236
AM 55	AMC 361574	4152	237
AM 56	AMC 361575	4152	238
AM 57	AMC 361576	4152	239
AM 58	AMC 361577	4152	240
AM 59	AMC 361578	4152	241
AM 60	AMC 361579	4152	242
AM 61	AMC 361580	4152	243
AM 62	AMC 361581	4152	244
AM 63	AMC 361582	4152	245
AM 64	AMC 361583	4152	246
AM 65	AMC 361584	4152	247
AM 66	AMC 361585	4152	248
AM 67	AMC 361586	4152	249
AM 68	AMC 361587	4152	250
AM 69	AMC 361588	4152	251
AM 70	AMC 361589	4152	252
AM 71	AMC 361590	4152	253
AM 72	AMC 361591	4152	254
AM 73	AMC 361592	4152	255
AM 74	AMC 361593	4152	256
AM 75	AMC 361594	4152	257
AM 76	AMC 361595	4152	258
AM 77	AMC 361596	4152	259
AM 78	AMC 361597	4152	260
AM 79	AMC 361598	4152	261
AM 80	AMC 361599	4152	262
AM 81	AMC 361600	4152	263
AM 82	AMC 361601	4152	264
AM 83	AMC 361602	4152	265
AM 84	AMC 361603	4152	266
AM 85	AMC 361604	4152	267
AM 86	AMC 361605	4152	268
AM 87	AMC 361606	4152	269
AM 88	AMC 361607	4152	270
AM 89	AMC 361608	4152	271
AM 90	AMC 361609	4152	272
AM 91	AMC 361610	4152	273
AM 92	AMC 361611	4152	274
AM 93	AMC 361612	4152	275
AM 94	AMC 361613	4152	276

PHOENIX ARIZONA

2010 AUG 10 P 12: 34

RECEIVED  
BLM AZ STATE OFFICE

47/50

**Anderson Mine Claims, Yavapai County, Arizona**

Claim Name	BLM Serial Number	Yavapai County Book	Page
AM 95	AMC 361614	4152	277
AM 96	AMC 361615	4152	278
AM 97	AMC 361616	4152	279
AM 98	AMC 361617	4152	280
AM 99	AMC 361618	4152	281
AM 100	AMC 361619	4152	282
AM 101	AMC 361620	4152	283
AM 102	AMC 361621	4152	284
AM 103	AMC 361622	4152	285
AM 104	AMC 361623	4152	286
AM 105	AMC 361624	4152	287
AM 106	AMC 361625	4152	288
AM 107	AMC 361626	4152	289
AM 108	AMC 361627	4152	290
AM 109	AMC 361628	4152	291
AM 110	AMC 361629	4152	292
AM 111	AMC 361630	4152	293
AM 112	AMC 361631	4152	294
AM 113	AMC 361632	4152	295
AM 114	AMC 361633	4152	296
AM 115	AMC 361634	4152	297
AM 116	AMC 361635	4152	298
AM 117	AMC 361636	4152	299
AM 118	AMC 361637	4152	300
AM 119	AMC 361638	4152	301
AM 120	AMC 361639	4152	302
AM 121	AMC 361640	4152	303
AM 122	AMC 361641	4152	304
AM 123	AMC 361642	4152	305
AM 124	AMC 361643	4152	306
AM 125	AMC 361644	4152	307
AM 126	AMC 361645	4152	308
AM 127	AMC 361646	4152	309
AM 128	AMC 361647	4152	310
AM 129	AMC 361648	4152	311
AM 130	AMC 361649	4152	312
AM 131	AMC 361650	4152	313
AM 132	AMC 361651	4152	314
AM 133	AMC 361652	4152	315
AM 134	AMC 361653	4152	316
AM 135	AMC 361654	4152	317
AM 136	AMC 361655	4152	318
AM 137	AMC 361656	4152	319
AM 138	AMC 361657	4152	320
AM 139	AMC 361658	4152	321
AM 140	AMC 361659	4152	322
AM 141	AMC 361660	4152	323

RECEIVED  
 BLM AZ STATE OFFICE  
 2010 AUG 10 P 12: 34

47/5

**Anderson Mine Claims, Yavapai County, Arizona**

<b>Claim Name</b>	<b>BLM Serial Number</b>	<b>Yavapai County Book</b>	<b>Page</b>
<del>AM</del> 142	AMC 361661	4152	324
<del>AM</del> 143	AMC 361662	4152	325
<del>AM</del> 144	AMC 361663	4152	326
<del>AM</del> 145	AMC 361664	4152	327
<del>AM</del> 146	AMC 361665	4152	328
<del>AM</del> 147	AMC 361666	4152	329
<del>AM</del> 148	AMC 361667	4152	330
<del>AM</del> 149	AMC 361668	4152	331
<del>AM</del> 150	AMC 361669	4152	332
<del>AM</del> 151	AMC 361670	4152	333
<del>AM</del> 152	AMC 361671	4152	334
<del>AM</del> 153	AMC 361672	4152	335
<del>AM</del> 154	AMC 361673	4152	336
<del>AM</del> 155	AMC 361674	4152	337
<del>AM</del> 156	AMC 361675	4152	338
<del>AM</del> 157	AMC 361676	4152	339
<del>AM</del> 158	AMC 361677	4152	340
<del>AM</del> 159	AMC 361678	4152	341
<del>AM</del> 160	AMC 361679	4152	342
<del>AM</del> 161	AMC 361680	4152	343
<del>AM</del> 162	AMC 361681	4152	344
<del>AM</del> 163	AMC 361682	4152	345
<del>AM</del> 164	AMC 361683	4152	346
<del>AM</del> 165	AMC 361684	4152	347
<del>AM</del> 166	AMC 361685	4152	348
<del>AM</del> 167	AMC 361686	4152	349
<del>AM</del> 168	AMC 361687	4152	350
<del>AM</del> 169	AMC 361688	4152	351
<del>AM</del> 170	AMC 361689	4152	352
<del>AM</del> 171	AMC 361690	4152	353
<del>AM</del> 172	AMC 361691	4152	354
<del>AM</del> 173	AMC 361692	4152	355
<del>AM</del> 174	AMC 361693	4152	356
<del>AM</del> 175	AMC 361694	4152	357
<del>AM</del> 176	AMC 361695	4152	358
<del>AM</del> 177	AMC 361696	4152	359
<del>AM</del> 178	AMC 361697	4152	360
<del>AM</del> 179	AMC 361698	4152	361
<del>AM</del> 180	AMC 361699	4152	362
<del>AM</del> 181	AMC 361700	4152	363
<del>AM</del> 182	AMC 361701	4152	364
<del>AM</del> 183	AMC 361702	4152	365
<del>AM</del> 184	AMC 361703	4152	366
<del>AM</del> 185	AMC 361704	4152	367
<del>AM</del> 186	AMC 361705	4152	368
<del>AM</del> 187	AMC 361706	4152	369
<del>AM</del> 188	AMC 361707	4152	370

PHOENIX, ARIZONA

2010 AUG 10 P 12: 34

RECEIVED  
BLM AZ STATE OFFICE

47/50



### Anderson Mine Claims, Yavapai County, Arizona

Claim Name	BLM Serial Number	Yavapai County Book	Page
AM 189	AMC 361708	4152	371
AM 190	AMC 361709	4152	372
AM 191	AMC 361710	4152	373
AM 192	AMC 361711	4152	374
AM 193	AMC 361712	4152	375
AM 194	AMC 361713	4152	376
AM 195	AMC 361714	4152	377
AM 196	AMC 361715	4152	378
AM 197	AMC 361716	4152	379
AM 198	AMC 361717	4152	380
AM 199	AMC 361718	4152	381
AM 200	AMC 361719	4152	382
AM 201	AMC 361720	4152	383
AM 202	AMC 361721	4152	384
AM 203	AMC 361722	4152	385
AM 204	AMC 361723	4152	386
AM 205	AMC 361724	4152	387
AM 206	AMC 361725	4152	388
AM 207	AMC 361726	4152	389
AM 208	AMC 361727	4152	390
AM 209	AMC 361728	4152	391
AM 210	AMC 361729	4152	392
AM 211	AMC 361730	4152	393
AM 212	AMC 361731	4152	394
AM 213	AMC 361732	4152	395
AM 214	AMC 361733	4152	396
AM 215	AMC 361734	4152	397
AM 216	AMC 361735	4152	398
AM 246	AMC 361736	4152	399
AM 247	AMC 361737	4152	400
AM 248	AMC 361738	4152	401
AM 249	AMC 361739	4152	402
AM 250	AMC 361740	4152	403
AM 251	AMC 361741	4152	404
AM 252	AMC 361742	4152	405
AM 253	AMC 361743	4152	406
AM 254	AMC 361744	4152	407
AM 255	AMC 361745	4152	408
AM 256	AMC 361746	4152	409
AM 257	AMC 361747	4152	410
AM 258	AMC 361748	4152	411
AM 259	AMC 361749	4152	412
AM 260	AMC 361750	4152	413
AM 261	AMC 361751	4152	414
AM 262	AMC 361752	4152	415
AM 263	AMC 361753	4152	416
AM 264	AMC 361754	4152	417

PUBLIC MIX & ARIZONA

2010 AUG 10 P 12: 35

RECEIVED  
 BLM AZ STATE OFFICE

47/52

**Anderson Mine Claims, Yavapai County, Arizona**

Claim Name	BLM Serial Number	Yavapai County Book	Page
AM 265	AMC 365258	4257	894
AM 266	AMC 365259	4257	895
AM 267	AMC 365260	4257	896
AM 268	AMC 365261	4257	897
AM 269	AMC 365262	4257	898
AM 270	AMC 365263	4257	899
AM 271	AMC 365264	4257	900
AM 272	AMC 365265	4257	901
AM 273	AMC 365266	4257	902
AM 274	AMC 365267	4257	903
AM 275	AMC 365268	4257	904
AM 276	AMC 365269	4257	905
AM 277	AMC 365270	4257	906
AM 278	AMC 365271	4257	907
AM 279	AMC 365272	4257	908
AM 280	AMC 365273	4257	909
AM 281	AMC 365274	4257	910
AM 282	AMC 365275	4257	911
AM 283	AMC 365276	4257	912
AM 284	AMC 365277	4257	913
AM 285	AMC 365278	4257	914
AM 286	AMC 365279	4257	915
AM 287	AMC 365280	4257	916
AM 288	AMC 365281	4257	917
AM 289	AMC 365282	4257	918
AM 290	AMC 365283	4257	919
AM 291	AMC 365284	4257	920
AM 292	AMC 365285	4257	921
AM 293	AMC 365286	4257	922
AM 294	AMC 365287	4257	923
AM 295	AMC 365288	4257	924
AM 296	AMC 365289	4257	925
AM 297	AMC 365290	4257	926
AM 298	AMC 365291	4257	927
AM 299	AMC 365292	4257	928
AM 300	AMC 365293	4257	929
AM 301	AMC 365294	4257	930
AM 302	AMC 366483	4285	507
AM 303	AMC 366484	4285	508
AM 304	AMC 366485	4285	509
AM 305	AMC 366486	4285	510
AM 306	AMC 366487	4285	511
AM 307	AMC 366488	4285	512
AM 308	AMC 366489	4285	513
AM 309	AMC 366490	4285	514
CE1	AMC 366751	4293	962
CE2	AMC 366752	4293	963

PHOENIX ARIZONA

2010 AUG 10 P 12:35

RECEIVED  
BLM AZ STATE OFFICE

41/50

**Anderson Mine Claims, Yavapai County, Arizona**

<b>Claim Name</b>	<b>BLM Serial Number</b>	<b>Yavapai County Book</b>	<b>Page</b>
CE3	AMC 366753	4293	964
CE4	AMC 366754	4293	956
CE5	AMC 366755	4293	957
CE6	AMC 366756	4293	958
CE7	AMC 366757	4293	959
CE8	AMC 366758	4293	960
PH1	AMC 366759	4293	961

**ENTERED INTO COMPUTER**

**AUG 1 8 2010**

RECEIVED  
BLM AZ STATE OFFICE  
2010 AUG 10 P 12: 35  
PHOENIX, ARIZONA

7/50

**United States Department of the Interior**  
**Bureau of Land Management**  
 LANDS/RECREATION & PLANNING  
 ONE N CENTRAL AVE  
 PHOENIX, AZ 85004 -2203  
 Phone:

Receipt

No: 2187630

<b>Transaction #:</b> 2257320		<b>ENTERED INTO COMPUTER</b> <i>h</i>
<b>Date of Transaction:</b> 08/10/2010		
<b>CUSTOMER:</b>	GLOBAL URANIUM CORPORATION 837 W HASTINGS ST S VANCOUVER, BC V6C 3N6 CA ✓	AUG 18 2010

LINE #	QTY	DESCRIPTION	REMARKS	UNIT PRICE	TOTAL
1	1.00	LOCATABLE MINERALS / MINING CLAIMS-NOT NEW-UNADJUD, ONE AUTH NO. ONLY / MINING CLAIM MONEY RECEIVED CASES: AMC361520/\$40460.00	MAINT (289) 2011	- n/a -	40460.00 ✓
<b>TOTAL:</b>					<b>\$40,460.00</b>

PAYMENT INFORMATION			
NOTE: Items will appear on credit card statement as "Bureau of Land Mgmt CO".			
1	AMOUNT:	1260.00	POSTMARKED: N/A
	TYPE:	CREDIT CARD	RECEIVED: 08/10/2010
	NAME:	GLOBAL URANIUM CORPORATION 837 W HASTINGS ST S VANCOUVER BC V6C 3N6 CA	
	CARD NO:	XXXXXXXXXXXX3013	AUTH CODE: 033369
	NAME ON CARD:	GEORGE W HEARD GOLBAL MINERALS LTD	
	EXPIRES:	02/2014	
	SIGNATURE:		
2	AMOUNT:	39200.00	POSTMARKED: N/A
	TYPE:	CHECK	RECEIVED: 08/10/2010
	CHECK NO:	388629	
	NAME:	GLOBAL URANIUM CORPORATION 837 W HASTINGS ST S VANCOUVER BC V6C 3N6 CA	

REMARKS

This receipt was generated by the automated BLM Collections and Billing System and is a paper representation of a portion of the official electronic record contained therein.



Amc 361520  
365258  
366483  
366751  
388128  
393473

Department of the Interior,  
Bureau of Land Management  
One North Central Avenue, Suite 800  
Phoenix, AZ 85004-4427  
602 417-9200

RECEIVED  
BLM. AZ STATE OFFICE  
2008 AUG 18 P 2:16  
PHOENIX, ARIZONA

August 18, 2008

Gentlemen:

Enclosed is our check # 31036, in the amount of \$46,250.00, to cover the maintenance fees for the claims that the company controls in Yavapai County. There are 370 claims, delineated in Table 1, attached.

Please be aware that Anderson Mining Company is a wholly-owned subsidiary of CONCENTRIC ENERGY, INCORPORATED.

Thank you for your attention to this matter.

Sincerely,

Ed Huskinson, Jr  
Project Manager

ENTERED INTO COMPUTER  
SEP 09 2008  
EB

#1764155

**Table 1**  
**Anderson Mining Claims**  
**Yavapai County, Arizona**

Claim Name	Serial #	Book	Page
AM 1	361520	4152	183
AM 2	361521	4152	184
AM 3	361522	4152	185
AM 4	361523	4152	186
AM 5	361524	4152	187
AM 6	361525	4152	188
AM 7	361526	4152	189
AM 8	361527	4152	190
AM 9	361528	4152	191
AM 10	361529	4152	192
AM 11	361530	4152	193
AM 12	361531	4152	194
AM 13	361532	4152	195
AM 14	361533	4152	196
AM 15	361534	4152	197
AM 16	361535	4152	198
AM 17	361536	4152	199
AM 18	361537	4152	200
AM 19	361538	4152	201
AM 20	361539	4152	202
AM 21	361540	4152	203
AM 22	361541	4152	204
AM 23	361542	4152	205
AM 24	361543	4152	206
AM 25	361544	4152	207
AM 26	361545	4152	208
AM 27	361546	4152	209
AM 28	361547	4152	210
AM 29	361548	4152	211
AM 30	361549	4152	212
AM 31	361550	4152	213
AM 32	361551	4152	214
AM 33	361552	4152	215
AM 34	361553	4152	216
AM 35	361554	4152	217
AM 36	361555	4152	218
AM 37	361556	4152	219
AM 38	361557	4152	220

PHOENIX, ARIZONA

2008 AUG 18 P 2:16

RECEIVED  
 B.L.M. AZ STATE OFFICE

Claim Name	Serial #	Book	Page
AM 39	361558	4152	221
AM 40	361559	4152	222
AM 41	361560	4152	223
AM 42	361561	4152	224
AM 43	361562	4152	225
AM 44	361563	4152	226
AM 45	361564	4152	227
AM 46	361565	4152	228
AM 47	361566	4152	229
AM 48	361567	4152	230
AM 49	361568	4152	231
AM 50	361569	4152	232
AM 51	361570	4152	233
AM 52	361571	4152	234
AM 53	361572	4152	235
AM 54	361573	4152	236
AM 55	361574	4152	237
AM 56	361575	4152	238
AM 57	361576	4152	239
AM 58	361577	4152	240
AM 59	361578	4152	241
AM 60	361579	4152	242
AM 61	361580	4152	243
AM 62	361581	4152	244
AM 63	361582	4152	245
AM 64	361583	4152	246
AM 65	361584	4152	247
AM 66	361585	4152	248
AM 67	361586	4152	249
AM 68	361587	4152	250
AM 69	361588	4152	251
AM 70	361589	4152	252
AM 71	361590	4152	253
AM 72	361591	4152	254
AM 73	361592	4152	255
AM 74	361593	4152	256
AM 75	361594	4152	257
AM 76	361595	4152	258
AM 77	361596	4152	259
AM 78	361597	4152	260
AM 79	361598	4152	261

PHOENIX, ARIZONA

2008 AUG 18 P 2:16

RECEIVED  
B.L.M. AZ STATE OFFICE

Claim Name	Serial #	Book	Page
AM 80	361599	4152	262
AM 81	361600	4152	263
AM 82	361601	4152	264
AM 83	361602	4152	265
AM 84	361603	4152	266
AM 85	361604	4152	267
AM 86	361605	4152	268
AM 87	361606	4152	269
AM 88	361607	4152	270
AM 89	361608	4152	271
AM 90	361609	4152	272
AM 91	361610	4152	273
AM 92	361611	4152	274
AM 93	361612	4152	275
AM 94	361613	4152	276
AM 95	361614	4152	277
AM 96	361615	4152	278
AM 97	361616	4152	279
AM 98	361617	4152	280
AM 99	361618	4152	281
AM 100	361619	4152	282
AM 101	361620	4152	283
AM 102	361621	4152	284
AM 103	361622	4152	285
AM 104	361623	4152	286
AM 105	361624	4152	287
AM 106	361625	4152	288
AM 107	361626	4152	289
AM 108	361627	4152	290
AM 109	361628	4152	291
AM 110	361629	4152	292
AM 111	361630	4152	293
AM 112	361631	4152	294
AM 113	361632	4152	295
AM 114	361633	4152	296
AM 115	361634	4152	297
AM 116	361635	4152	298
AM 117	361636	4152	299
AM 118	361637	4152	300
AM 119	361638	4152	301
AM 120	361639	4152	302
AM 121	361640	4152	303

RECEIVED  
B.L.M. AZ STATE OFFICE  
2008 AUG 18 P 2:16  
PHOENIX, ARIZONA



Claim Name	Serial #	Book	Page
AM 122	361641	4152	304
AM 123	361642	4152	305
AM 124	361643	4152	306
AM 125	361644	4152	307
AM 126	361645	4152	308
AM 127	361646	4152	309
AM 128	361647	4152	310
AM 129	361648	4152	311
AM 130	361649	4152	312
AM 131	361650	4152	313
AM 132	361651	4152	314
AM 133	361652	4152	315
AM 134	361653	4152	316
AM 135	361654	4152	317
AM 136	361655	4152	318
AM 137	361656	4152	319
AM 138	361657	4152	320
AM 139	361658	4152	321
AM 140	361659	4152	322
AM 141	361660	4152	323
AM 142	361661	4152	324
AM 143	361662	4152	325
AM 144	361663	4152	326
AM 145	361664	4152	327
AM 146	361665	4152	328
AM 147	361666	4152	329
AM 148	361667	4152	330
AM 149	361668	4152	331
AM 150	361669	4152	332
AM 151	361670	4152	333
AM 152	361671	4152	334
AM 153	361672	4152	335
AM 154	361673	4152	336
AM 155	361674	4152	337
AM 156	361675	4152	338
AM 157	361676	4152	339
AM 158	361677	4152	340
AM 159	361678	4152	341
AM 160	361679	4152	342
AM 161	361680	4152	343
AM 162	361681	4152	344
AM 163	361682	4152	345

RECEIVED  
B.L.M. AZ STATE OFFICE  
2008 AUG 18 P 2:16  
PHOENIX, ARIZONA

Claim Name	Serial #	Book	Page
AM 164	361683	4152	346
AM 165	361684	4152	347
AM 166	361685	4152	348
AM 167	361686	4152	349
AM 168	361687	4152	350
AM 169	361688	4152	351
AM 170	361689	4152	352
AM 171	361690	4152	353
AM 172	361691	4152	354
AM 173	361692	4152	355
AM 174	361693	4152	356
AM 175	361694	4152	357
AM 176	361695	4152	358
AM 177	361696	4152	359
AM 178	361697	4152	360
AM 179	361698	4152	361
AM 180	361699	4152	362
AM 181	361700	4152	363
AM 182	361701	4152	364
AM 183	361702	4152	365
AM 184	361703	4152	366
AM 185	361704	4152	367
AM 186	361705	4152	368
AM 187	361706	4152	369
AM 188	361707	4152	370
AM 189	361708	4152	371
AM 190	361709	4152	372
AM 191	361710	4152	373
AM 192	361711	4152	374
AM 193	361712	4152	375
AM 194	361713	4152	376
AM 195	361714	4152	377
AM 196	361715	4152	378
AM 197	361716	4152	379
AM 198	361717	4152	380
AM 199	361718	4152	381
AM 200	361719	4152	382
AM 201	361720	4152	383
AM 202	361721	4152	384
AM 203	361722	4152	385
AM 204	361723	4152	386
AM 205	361724	4152	387

PHOENIX, ARIZONA

2009 AUG 18 P 2: 16

RECEIVED  
B.L.M. AZ STATE OFFICE

Claim Name	Serial #	Book	Page
AM 206	361725	4152	388
AM 207	361726	4152	389
AM 208	361727	4152	390
AM 209	361728	4152	391
AM 210	361729	4152	392
AM 211	361730	4152	393
AM 212	361731	4152	394
AM 213	361732	4152	395
AM 214	361733	4152	396
AM 215	361734	4152	397
AM 216	361735	4152	398
AM 246	361736	4152	399
AM 247	361737	4152	400
AM 248	361738	4152	401
AM 249	361739	4152	402
AM 250	361740	4152	403
AM 251	361741	4152	404
AM 252	361742	4152	405
AM 253	361743	4152	406
AM 254	361744	4152	407
AM 255	361745	4152	408
AM 256	361746	4152	409
AM 257	361747	4152	410
AM 258	361748	4152	411
AM 259	361749	4152	412
AM 260	361750	4152	413
AM 261	361751	4152	414
AM 262	361752	4152	415
AM 263	361753	4152	416
AM 264	361754	4152	417
AM 265	365258	4257	894
AM 266	365259	4257	895
AM 267	365260	4257	896
AM 268	365261	4257	897
AM 269	365262	4257	898
AM 270	365263	4257	899
AM 271	365264	4257	900
AM 272	365265	4257	901
AM 273	365266	4257	902
AM 274	365267	4257	903
AM 275	365268	4257	904

RECEIVED  
 B.L.M. AZ STATE OFFICE  
 2008 AUG 18 P 2:16  
 PHOENIX, ARIZONA

Name	Serial #	Book	Page
AM 276	365269	4257	905
AM 277	365270	4257	906
AM 278	365271	4257	907
AM 279	365272	4257	908
AM 280	365273	4257	909
AM 281	365274	4257	910
AM 282	365275	4257	911
AM 283	365276	4257	912
AM 284	365277	4257	913
AM 285	365278	4257	914
AM 286	365279	4257	915
AM 287	365280	4257	916
AM 288	365281	4257	917
AM 289	365282	4257	918
AM 290	365283	4257	919
AM 291	365284	4257	920
AM 292	365285	4257	921
AM 293	365286	4257	922
AM 294	365287	4257	923
AM 295	365288	4257	924
AM 296	365289	4257	925
AM 297	365290	4257	926
AM 298	365291	4257	927
AM 299	365292	4257	928
AM 300	365293	4257	929
AM 301	365294	4257	930
AM 302	366483	4285	507
AM 303	366484	4285	508
AM 304	366485	4285	509
AM 305	366486	4285	510
AM 306	366487	4285	511
AM 307	366488	4285	512
AM 308	366489	4285	513
AM 309	366490	4285	514
CE1	366751	4293	962
CE2	366752	4293	963
CE3	366753	4293	964
CE4	366754	4293	956
CE5	366755	4293	957
CE6	366756	4293	958
CE7	366757	4293	959
CE8	366758	4293	960
TH1	366759	4293	961

Note: these 9 claims are  
placer claims

PHOENIX, ARIZONA

2008 AUG 18 P 2:16

RECEIVED  
B.L.M. AZ STATE OFFICE

**CLAIMS LOCATED IN FALL, 2007  
YAVAPAI COUNTY, ARIZONA  
ANDERSON MINING COMPANY**

Claim Name	Serial #	Book	Page	Sec	Township	Range
AM-217	388128	4553	789	9 & 10	11N	10W
AM-218	388129	4553	790	9 & 10	11N	10W
AM-219	388130	4553	791	9 & 10	11N	10W
AM-220	388131	4553	792	10	11N	10W
AM-221	388132	4553	793	10	11N	10W
AM-222	388133	4553	794	10	11N	10W
AM-223	388134	4553	795	3 & 10	11N	10W
AM-224	388135	4553	796	3 & 10	11N	10W
AM-225	388136	4553	797	3	11N	10W
AM-226	388137	4553	798	3 & 10	11N	10W
AM-227	388138	4553	799	3	11N	10W
AM-228	388139	4553	800	3	11N	10W
AM-229	388140	4553	801	3	11N	10W
AM-230	388141	4553	802	3	11N	10W
AM-231	388142	4553	803	10 & 11	11N	10W
AM-232	388143	4553	804	11	11N	10W
AM-233	388144	4553	805	10 & 11	11N	10W
AM-234	388145	4553	806	11	11N	10W
AM-235	388146	4553	807	2,3,10,11	11N	10W
AM-236	388147	4553	808	11	11N	10W
AM-237	388148	4553	809	2,3, & 11	11N	10W
AM-238	388149	4553	810	2 & 11	11N	10W
AM-239	388150	4553	811	11	11N	10W
AM-240	388151	4553	812	11	11N	10W
AM-241	388152	4553	813	11	11N	10W
AM-242	388153	4553	814	11	11N	10W
AM-243	388154	4553	815	11	11N	10W
AM-244	388155	4553	816	11 & 12	11N	10W
AM-245	388156	4553	817	2 & 11	11N	10W
AM-310	388157	4553	818	11 & 12	11N	10W
AM-311	388158	4553	819	2 & 11	11N	10W
AM-312	388159	4553	820	2,11,12	11N	10W
AM-313	388160	4553	821	1,2,11,12	11N	10W
AM-314	388161	4553	822	12		
AM-315	388162	4553	823	12	11N	10W
AM-316	388163	4553	824	11 & 12	11N	10W

RECEIVED  
B.L.M. AZ STATE OFFICE  
2008 AUG 18 P 2:16  
PHOENIX, ARIZONA

Claim Name	Serial #	Book	Page	Sec	Township	Range
AM-317	388164	4553	825	11 & 12	11N	10W
AM-318	388165	4553	826	12	11N	10W
AM-319	388166	4553	827	11 & 12	11N	10W
AM-320	388167	4553	828	12	11N	10W
AM-321	388168	4553	829	11 & 12	11N	10W
AM-322	388169	4553	830	12	11N	10W
AM-323	388170	4553	831	11 & 12	11N	10W
AM-324	388171	4553	832	12	11N	10W
AM-325	388172	4553	833	13 & 18	11N	9 & 10 W
AM-326	388173	4553	834	13	11N	10W
AM-327	388174	4553	835	13 & 18	11N	9 & 10 W
AM-328	388175	4553	836	3,18,19,2	11N	9 & 10 W
AM-329	388176	4553	837	18 & 19	11N	9W
AM-330	388177	4553	838	13 & 24	11N	10W
AM-331	388178	4553	839	19 & 24	11N	9 & 10 W
AM-332	388179	4553	840	24	11N	10W
AM-333	388180	4553	841	19 & 24	11N	9 & 10 W
AM-334	388181	4553	842	24	11N	10W
AM-335	388182	4553	843	19 & 24	11N	9 & 10 W
AM-336	388183	4553	844	24	11N	10W
AM-337	388184	4553	845	19 & 24	11N	9 & 10 W
AM-338	388185	4553	946	24	11N	10W
AM-339	388186	4553	847	19 & 24	11N	9 & 10 W
AM-340	388187	4553	848	24	11N	10W
AM-341	388188	4553	849	19 & 24	11N	9 & 10 W
AM-342	388189	4553	850	24	11N	10W
AM-343	388190	4553	851	19 & 24	11N	9 & 10 W
AM-344	388191	4553	852	24	11N	10W
AM-345	388192	4553	853	19 & 24	11N	9 & 10 W
AM-346	388193	4553	854	24 & 25	11N	10W
AM-347	388194	4553	855	9,24,25,3	11N	9 & 10 W
AM-348	388195	4553	856	24 & 25	11N	10W
AM-349	388196	4553	857	25 & 30	11N	9 & 10 W
AM-350	388197	4553	858	25	11N	10W
AM-351	388198	4553	859	25	11N	10W
AM-352	388199	4553	860	25	11N	10W
AM-353	388200	4553	861	25	11N	10W
AM-354	388201	4553	862	25	11N	10W
AM-355	388202	4553	863	25	11N	10W
AM-356	388203	4553	864	25	11N	10W
AM-357	388204	4553	865	25	11N	10W

PHOENIX, ARIZONA

2008 AUG 18 P 2: 16

RECEIVED  
B.L.M. AZ STATE OFFICE

**CLAIMS LOCATED IN SPRING, 2008**

Claim Name	Serial #	Book	Page	Sec	Township	Range
AM-358	393473	4602	328	21	11N	10W
AM-359	393474	4602	329	21	11N	10W
AM-360	393475	4602	330	21	11N	10W
AM-361	393476	4602	331	21	11N	10W

**There are 370 claims, total, as of August, 2008**

RECEIVED  
B.L.M. AZ STATE OFFICE  
2008 AUG 18 P 2: 16  
PHOENIX, ARIZONA

Message:

370 ROWS RETRIEVED

### CBS Export Results Report

Include Resolved Records

*Record Status*

- Error Records (E/M/I)
- Accepted Records (A/W)
- "On Hold" Records (H)
- All Records (for s/n or receipt nr)
- Exported, No Results From CBS
- New (not yet exported)

*Search Criteria Responsible Area (Err*

Enter export Date (mm/dd/yyyy) ALL

User (U,X)

Serial Number match (optional)

Programmer (P,X)

Receipt Nr (optional) 1764155

All (U,P,X)

Export Nr (exclusive)

LR2000 User (defaults to login) ALL

[User Guide](#)

	Resend?	Export Nr	A/D	Serial Nr	Mult	Code	\$ Amount	Remarks	Receipt Nr	LR2000 User	#Msg	Resolve
1	<input type="checkbox"/>	2002093	A	AMC361520		582	125.00	2009	1764155	P5BROWN		<input type="checkbox"/>



United States Department of the Interior  
 Bureau of Land Management  
 BUSINESS & SUPPORT SVCS DIV  
 ONE N CENTRAL AVE SUITE 800  
 PHOENIX, AZ 85004 -4427  
 Phone: (602) 417-9200

Receipt

No:

1764155

Transaction #: 1821740		<b>ENTERED INTO COMPUTER</b>
Date of Transaction: 08/18/2008		
CUSTOMER:	ANDERSON MINING COMPANY 3550 SABIN BROWN RD STE 3 WICKENBURG, AZ 85390	SEP 09 2008 PB + VERIFIED

LINE #	QTY	DESCRIPTION	REMARKS	UNIT PRICE	TOTAL
1	1.00	LOCATABLE MINERALS / MINING CLAIMS-NOT NEW-UNADJUD, ONE AUTH NO. ONLY / MINING CLAIM MONEY RECEIVED (455) CASES: AMC361520/\$46250.00	MAINT 2009 (370)	- n/a -	46250.00
<b>TOTAL:</b>					<b>\$46,250.00</b>

PAYMENT INFORMATION			
1	AMOUNT:	\$46,250.00	POSTMARKED: N/A
	TYPE:	CHECK	RECEIVED: 08/18/2008
	CHECK NO:	31036	
	NAME:	ANDERSON MINING COMPANY 3550 SABIN BROWN RD STE 3 WICKENBURG AZ 85390	

REMARKS

This receipt was generated by the automated BLM Collections and Billing System and is a paper representation of a portion of the official electronic record contained therein.



CONCENTRIC ENERGY CORP

Amc 361520

365258

366483

366751

August 20, 2007

Department of the Interior,  
Bureau of Land Management  
One North Central Avenue, Suite 800  
Phoenix, AZ 85004-4427  
602 417-9200

Gentlemen:

Enclosed is check # 6401, in the amount of \$ 36,125.00, to cover the maintenance fees for the claims controlled by Concentric Energy Corporation in Yavapai County, Arizona. There are 289 claims, delineated in Table 1, below.

Please note that the Claimant for many of the claims listed in Table 1 was change by Quitclaim Transfer on April 25, 2007 from Ralph Kettell to Concentric Energy Corp.

Thank you for your attention to this matter.

Sincerely,

Thomas F. Fudge Jr.  
President and CEO  
Concentric Energy Corp.

RECEIVED  
B.L.M. AZ STATE OFFICE  
2007 AUG 23 A 9: 00  
PHOENIX, ARIZONA

**Table 1  
Anderson Mine Mining Claims  
Yavapai County, Arizona**

Claim Name	Serial #	Book	Page
AM 1	361520	4152	183
AM 2	361521	4152	184
AM 3	361522	4152	185
AM 4	361523	4152	186
AM 5	361524	4152	187
AM 6	361525	4152	188
AM 7	361526	4152	189
AM 8	361527	4152	190
AM 9	361528	4152	191
AM 10	361529	4152	192
AM 11	361530	4152	193
AM 12	361531	4152	194
AM 13	361532	4152	195
AM 14	361533	4152	196
AM 15	361534	4152	197
AM 16	361535	4152	198
AM 17	361536	4152	199
AM 18	361537	4152	200
AM 19	361538	4152	201
AM 20	361539	4152	202
AM 21	361540	4152	203
AM 22	361541	4152	204
AM 23	361542	4152	205
AM 24	361543	4152	206
AM 25	361544	4152	207
AM 26	361545	4152	208
AM 27	361546	4152	209
AM 28	361547	4152	210
AM 29	361548	4152	211
AM 30	361549	4152	212
AM 31	361550	4152	213
AM 32	361551	4152	214
AM 33	361552	4152	215
AM 34	361553	4152	216
AM 35	361554	4152	217
AM 36	361555	4152	218
AM 37	361556	4152	219
AM 38	361557	4152	220
AM 39	361558	4152	221

RECEIVED  
 B.L.M. AZ STATE OFFICE  
 2007 AUG 23 A 9:00  
 PHOENIX

**ENTERED INTO COMPUTER**

Claim Name	Serial #	Book	Page
AM 40	361559	4152	222
AM 41	361560	4152	223
AM 42	361561	4152	224
AM 43	361562	4152	225
AM 44	361563	4152	226
AM 45	361564	4152	227
AM 46	361565	4152	228
AM 47	361566	4152	229
AM 48	361567	4152	230
AM 49	361568	4152	231
AM 50	361569	4152	232
AM 51	361570	4152	233
AM 52	361571	4152	234
AM 53	361572	4152	235
AM 54	361573	4152	236
AM 55	361574	4152	237
AM 56	361575	4152	238
AM 57	361576	4152	239
AM 58	361577	4152	240
AM 59	361578	4152	241
AM 60	361579	4152	242
AM 61	361580	4152	243
AM 62	361581	4152	244
AM 63	361582	4152	245
AM 64	361583	4152	246
AM 65	361584	4152	247
AM 66	361585	4152	248
AM 67	361586	4152	249
AM 68	361587	4152	250
AM 69	361588	4152	251
AM 70	361589	4152	252
AM 71	361590	4152	253
AM 72	361591	4152	254
AM 73	361592	4152	255
AM 74	361593	4152	256
AM 75	361594	4152	257
AM 76	361595	4152	258
AM 77	361596	4152	259
AM 78	361597	4152	260
AM 79	361598	4152	261
AM 80	361599	4152	262
AM 81	361600	4152	263
AM 82	361601	4152	264
AM 83	361602	4152	265

RECEIVED  
 B.L.M. AZ STATE OFFICE  
 2001 AUG 23 A 8: 59  
 PHOENIX, ARIZONA

Claim Name	Serial #	Book	Page
AM 84	361603	4152	266
AM 85	361604	4152	267
AM 86	361605	4152	268
AM 87	361606	4152	269
AM 88	361607	4152	270
AM 89	361608	4152	271
AM 90	361609	4152	272
AM 91	361610	4152	273
AM 92	361611	4152	274
AM 93	361612	4152	275
AM 94	361613	4152	276
AM 95	361614	4152	277
AM 96	361615	4152	278
AM 97	361616	4152	279
AM 98	361617	4152	280
AM 99	361618	4152	281
AM 100	361619	4152	282
AM 101	361620	4152	283
AM 102	361621	4152	284
AM 103	361622	4152	285
AM 104	361623	4152	286
AM 105	361624	4152	287
AM 106	361625	4152	288
AM 107	361626	4152	289
AM 108	361627	4152	290
AM 109	361628	4152	291
AM 110	361629	4152	292
AM 111	361630	4152	293
AM 112	361631	4152	294
AM 113	361632	4152	295
AM 114	361633	4152	296
AM 115	361634	4152	297
AM 116	361635	4152	298
AM 117	361636	4152	299
AM 118	361637	4152	300
AM 119	361638	4152	301
AM 120	361639	4152	302
AM 121	361640	4152	303
AM 122	361641	4152	304
AM 123	361642	4152	305
AM 124	361643	4152	306
AM 125	361644	4152	307
AM 126	361645	4152	308
AM 127	361646	4152	309

RECEIVED  
 B.L.M. AZ STATE OFFICE  
 2001 AUG 23 A 8:59  
 PHOENIX, ARIZONA

**ENTERED INTO COMPUTER**

Claim Name	Serial #	Book	Page
AM 128	361647	4152	310
AM 129	361648	4152	311
AM 130	361649	4152	312
AM 131	361650	4152	313
AM 132	361651	4152	314
AM 133	361652	4152	315
AM 134	361653	4152	316
AM 135	361654	4152	317
AM 136	361655	4152	318
AM 137	361656	4152	319
AM 138	361657	4152	320
AM 139	361658	4152	321
AM 140	361659	4152	322
AM 141	361660	4152	323
AM 142	361661	4152	324
AM 143	361662	4152	325
AM 144	361663	4152	326
AM 145	361664	4152	327
AM 146	361665	4152	328
AM 147	361666	4152	329
AM 148	361667	4152	330
AM 149	361668	4152	331
AM 150	361669	4152	332
AM 151	361670	4152	333
AM 152	361671	4152	334
AM 153	361672	4152	335
AM 154	361673	4152	336
AM 155	361674	4152	337
AM 156	361675	4152	338
AM 157	361676	4152	339
AM 158	361677	4152	340
AM 159	361678	4152	341
AM 160	361679	4152	342
AM 161	361680	4152	343
AM 162	361681	4152	344
AM 163	361682	4152	345
AM 164	361683	4152	346
AM 165	361684	4152	347
AM 166	361685	4152	348
AM 167	361686	4152	349
AM 168	361687	4152	350
AM 169	361688	4152	351
AM 170	361689	4152	352
AM 171	361690	4152	353

RECEIVED  
 B.L.M. AZ STATE OFFICE  
 2001 AUG 23 A 8:59  
 PHOENIX, ARIZONA

**ENTERED INTO COMPUTER**

Claim Name	Serial #	Book	Page
AM 172	361691	4152	354
AM 173	361692	4152	355
AM 174	361693	4152	356
AM 175	361694	4152	357
AM 176	361695	4152	358
AM 177	361696	4152	359
AM 178	361697	4152	360
AM 179	361698	4152	361
AM 180	361699	4152	362
AM 181	361700	4152	363
AM 182	361701	4152	364
AM 183	361702	4152	365
AM 184	361703	4152	366
AM 185	361704	4152	367
AM 186	361705	4152	368
AM 187	361706	4152	369
AM 188	361707	4152	370
AM 189	361708	4152	371
AM 190	361709	4152	372
AM 191	361710	4152	373
AM 192	361711	4152	374
AM 193	361712	4152	375
AM 194	361713	4152	376
AM 195	361714	4152	377
AM 196	361715	4152	378
AM 197	361716	4152	379
AM 198	361717	4152	380
AM 199	361718	4152	381
AM 200	361719	4152	382
AM 201	361720	4152	383
AM 202	361721	4152	384
AM 203	361722	4152	385
AM 204	361723	4152	386
AM 205	361724	4152	387
AM 206	361725	4152	388
AM 207	361726	4152	389
AM 208	361727	4152	390
AM 209	361728	4152	391
AM 210	361729	4152	392
AM 211	361730	4152	393
AM 212	361731	4152	394
AM 213	361732	4152	395
AM 214	361733	4152	396
AM 215	361734	4152	397

RECEIVED  
 B.L.M. AZ STATE OFFICE  
 2007 AUG 23 A 8:59  
 PHOENIX, ARIZONA

**ENTERED INTO COMPUTER**

Claim Name	Serial #	Book	Page
AM 216	361735	4152	398
AM 246	361736	4152	399
AM 247	361737	4152	400
AM 248	361738	4152	401
AM 249	361739	4152	402
AM 250	361740	4152	403
AM 251	361741	4152	404
AM 252	361742	4152	405
AM 253	361743	4152	406
AM 254	361744	4152	407
AM 255	361745	4152	408
AM 256	361746	4152	409
AM 257	361747	4152	410
AM 258	361748	4152	411
AM 259	361749	4152	412
AM 260	361750	4152	413
AM 261	361751	4152	414
AM 262	361752	4152	415
AM 263	361753	4152	416
AM 264	361754	4152	417
AM 265	365258	4257	894
AM 266	365259	4257	895
AM 267	365260	4257	896
AM 268	365261	4257	897
AM 269	365262	4257	898
AM 270	365263	4257	899
AM 271	365264	4257	900
AM 272	365265	4257	901
AM 273	365266	4257	902
AM 274	365267	4257	903
AM 275	365268	4257	904
AM 276	365269	4257	905
AM 277	365270	4257	906
AM 278	365271	4257	907
AM 279	365272	4257	908
AM 280	365273	4257	909
AM 281	365274	4257	910
AM 282	365275	4257	911
AM 283	365276	4257	912
AM 284	365277	4257	913
AM 285	365278	4257	914
AM 286	365279	4257	915
AM 287	365280	4257	916
AM 288	365281	4257	917

PHOENIX, ARIZONA

2001 AUG 23 A 8:59

RECEIVED  
B.L.M. AZ STATE OFFICE



Claim Name	Serial #	Book	Page
AM 289	365282	4257	918
AM 290	365283	4257	919
AM 291	365284	4257	920
AM 292	365285	4257	921
AM 293	365286	4257	922
AM 294	365287	4257	923
AM 295	365288	4257	924
AM 296	365289	4257	925
AM 297	365290	4257	926
AM 298	365291	4257	927
AM 299	365292	4257	928
AM 300	365293	4257	929
AM 301	365294 ✓	4257	930
AM 302	366483	4285	507
AM 303	366484	4285	508
AM 304	366485	4285	509
AM 305	366486	4285	510
AM 306	366487	4285	511
AM 307	366488	4285	512
AM 308	366489	4285	513
AM 309	366490 ✓	4285	514
CE1	366751	4293	962
CE2	366752	4293	963
CE3	366753	4293	964
CE4	366754	4293	956
CE5	366755	4293	957
CE6	366756	4293	958
CE7	366757	4293	959
CE8	366758	4293	960
TH1	366759	4293	961

**ENTERED INTO COMPUTER**

RECEIVED  
 B.L.M. AZ STATE OFFICE  
 2001 AUG 23 A 8: 59  
 PHOENIX, ARIZONA

**Message:**

289 ROWS RETRIEVED

**CBS Export Results Report**

Include Resolved Records

*Record Status*

*Search Criteria*

*Responsible Area (Errors Only)*

Error Records (E/M/I)

Enter export Date (mm/dd/yyyy) ALL

User (U,X)

Accepted Records (A/W)

Serial Number match (optional)

Programmer (P,X)

"On Hold" Records (H)

Receipt Nr (optional) 1551324

All (U,P,X)

All Records (for s/n or receipt nr)

Export Nr (exclusive)

Exported, No Results From CBS

LR2000 User (defaults to login) ALL

New (not yet exported)

Query

Reset

User Guide

	Resend?	Export Nr	A/D	Serial Nr	Mult	Code	\$ Amount	Remarks	Receipt Nr	LR2000 User	#Msg	Resolved?	OK	Stat1
1	<input type="checkbox"/>	1404418	A	AMC361520		582	125.00	2008	1551324	P5BROWN		<input type="checkbox"/>		

United States Department of the Interior  
 Bureau of Land Management  
 BUSINESS & SUPPORT SVCS DIV  
 ONE N CENTRAL AVE SUITE 800  
 PHOENIX, AZ 85004 -4427  
 Phone: (602) 417-9200

Receipt

No:

1551324

Transaction #: 1602844		<b>ENTERED INTO COMPUTER</b> AUG 30 2007 PB # VERIFIED
Date of Transaction: 08/23/2007		
CUSTOMER:	CONCENTRIC ENERGY CORP 3537 SPENCERVILLE ROAD SUITE 4 BURTONSVILLE, MD 20866	

LINE #	QTY	DESCRIPTION	REMARKS	UNIT PRICE	TOTAL
1	1.00	LOCATABLE MINERALS / MINING CLAIMS-NOT NEW-UNADJUD, ONE AUTH NO. ONLY / MINING CLAIM MONEY RECEIVED (455) CASES: AMC361520/\$36125.00	MAINT 2008 (289)	- n/a -	36125.00
<b>TOTAL:</b>					<b>\$36,125.00</b>

PAYMENT INFORMATION					
1	AMOUNT:	\$36,125.00	POSTMARKED:	8/22/07 0:00	
	TYPE:	CHECK	RECEIVED:	08/23/2007	
	CHECK NO:	6401			
	NAME:	CONCENTRIC ENERGY CORP 3537 SPENCERVILLE ROAD SUITE 4 BURTONSVILLE MD 20866			

REMARKS

This receipt was generated by the automated BLM Collections and Billing System and is a paper representation of a portion of the official electronic record contained therein.

<u>Range Numbers</u>	<u>Lead Num</u>
361520 - 361754	361520
365258 - 365294	365258
366483 - 366490	366483
366751 - 366759	366751

**ENTERED INTO COMPUTER**

AUG 30 2007 PB # VERIFIED

AMC 361520  
365258  
366483  
366751

August 10, 2006

Bureau of Land Management  
Arizona State Office  
1 North Central Avenue Suite 800  
Phoenix, AZ  
85004  
602-417-9200  
602-417-9528

Re: Payment of Maintenance Fees – AM Claim - 289 Claims

Enclosed with this letter are an Affidavit of Payment of Maintenance Fees and of Intention to Hold Mining Claims and a check for \$36,125.00 representing payment for each of the unpatented mining claims shown on Exhibit A. The full names of the claims, the county document number, and the BLM mining claim serial numbers assigned to the claims for which the fees are paid are described on the Exhibit A attached to the Affidavit and by this reference incorporated in this letter.

Please return the file-stamped original document to our office so that we may record it with the County.

If you have any questions please call me at the number below.  
Thank You for your assistance.

Sincerely;

Ralph Kettell  
Concentric Energy Corp.  
3537 Spencerville Road, Suite 4.  
Burtonsville Md. 20866  
1-301-422-0877

RECEIVED  
B.L.M. AZ STATE OFFICE

2006 AUG 22 A 9:47

PHOENIX, ARIZONA

ENTERED IN COMPUTER

Recorded at the request of  
and when recorded please return to:  
Ralph Kettell  
Concentric Energy Corp.  
3537 Spencerville Road, Suite 4.  
Burtonsville Md. 20866  
1-301-421-0877

RECEIVED  
B.L.M. AZ STATE OFFICE  
2006 AUG 22 A 9:48  
PHOENIX, ARIZONA

**Notice of Intent to Hold and Affidavit of Payment**

The undersigned gives notice as follows:

1. Concentric Energy Corp. is the owner of the Anderson Mine (AM, CE, & TH) mining claims which are located in Yavapai Counties, Arizona. The address of the owner is 3537 Spencerville Road, Suite 4, Burtonsville, Md. 20866.
2. The full names of the mining claims and the Bureau of Land Management mining claim serial numbers assigned to the mining claims are described in the exhibit attached to and by this reference incorporated in this Notice.
3. The owner held the claims for the assessment year ending on September 1, 2007 and intends to hold the claims for the assessment year ending on September 1, 2008.
4. The owner paid the federal annual mining claim maintenance fees for the assessment year ending on September 1, 2006 and paid the federal annual mining claim maintenance fees for the assessment year ending on September 1, 2007.

Dated August 14, 2006.

By 

RECEIVED  
B.L.M. AZ STATE OFFICE

2006 AUG 22 A 9:48

PHOENIX, ARIZONA

STATE OF *Maryland* )  
  )ss.  
COUNTY OF *Montgomery*

This Notice of Intent to Hold was acknowledged before me on August 12, 2006, by Ralph Keenall.

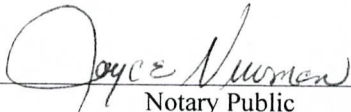
  
\_\_\_\_\_  
Notary Public

*My Commission Expires July 1, 2009*

Exhibit A  
Anderson Mine Mining Claims  
Yavapai Counties, Arizona

Claim Name	Serial #	Book	Page
AM 1	361520	4152	183
AM 2	361521	4152	184
AM 3	361522	4152	185
AM 4	361523	4152	186
AM 5	361524	4152	187
AM 6	361525	4152	188
AM 7	361526	4152	189
AM 8	361527	4152	190
AM 9	361528	4152	191
AM 10	361529	4152	192
AM 11	361530	4152	193
AM 12	361531	4152	194
AM 13	361532	4152	195
AM 14	361533	4152	196
AM 15	361534	4152	197
AM 16	361535	4152	198
AM 17	361536	4152	199
AM 18	361537	4152	200
AM 19	361538	4152	201
AM 20	361539	4152	202
AM 21	361540	4152	203
AM 22	361541	4152	204
AM 23	361542	4152	205
AM 24	361543	4152	206
AM 25	361544	4152	207
AM 26	361545	4152	208
AM 27	361546	4152	209
AM 28	361547	4152	210
AM 29	361548	4152	211
AM 30	361549	4152	212
AM 31	361550	4152	213
AM 32	361551	4152	214
AM 33	361552	4152	215
AM 34	361553	4152	216
AM 35	361554	4152	217
AM 36	361555	4152	218
AM 37	361556	4152	219
AM 38	361557	4152	220
AM 39	361558	4152	221
AM 40	361559	4152	222
AM 41	361560	4152	223
AM 42	361561	4152	224
AM 43	361562	4152	225
AM 44	361563	4152	226
AM 45	361564	4152	227

PHOENIX, ARIZONA

2006 AUG 22 A 9:48

RECEIVED  
B.L.M. AZ STATE OFFICE

AM 46	361565	4152	228
AM 47	361566	4152	229
AM 48	361567	4152	230
AM 49	361568	4152	231
AM 50	361569	4152	232
AM 51	361570	4152	233
AM 52	361571	4152	234
AM 53	361572	4152	235
AM 54	361573	4152	236
AM 55	361574	4152	237
AM 56	361575	4152	238
AM 57	361576	4152	239
AM 58	361577	4152	240
AM 59	361578	4152	241
AM 60	361579	4152	242
AM 61	361580	4152	243
AM 62	361581	4152	244
AM 63	361582	4152	245
AM 64	361583	4152	246
AM 65	361584	4152	247
AM 66	361585	4152	248
AM 67	361586	4152	249
AM 68	361587	4152	250
AM 69	361588	4152	251
AM 70	361589	4152	252
AM 71	361590	4152	253
AM 72	361591	4152	254
AM 73	361592	4152	255
AM 74	361593	4152	256
AM 75	361594	4152	257
AM 76	361595	4152	258
AM 77	361596	4152	259
AM 78	361597	4152	260
AM 79	361598	4152	261
AM 80	361599	4152	262
AM 81	361600	4152	263
AM 82	361601	4152	264
AM 83	361602	4152	265
AM 84	361603	4152	266
AM 85	361604	4152	267
AM 86	361605	4152	268
AM 87	361606	4152	269
AM 88	361607	4152	270
AM 89	361608	4152	271
AM 90	361609	4152	272
AM 91	361610	4152	273
AM 92	361611	4152	274
AM 93	361612	4152	275
AM 94	361613	4152	276

PHOENIX, ARIZONA

2006 AUG 22 A 9:48

RECEIVED  
B.L.M. AZ STATE OFFICE



AM 95	361614	4152	277
AM 96	361615	4152	278
AM 97	361616	4152	279
AM 98	361617	4152	280
AM 99	361618	4152	281
AM 100	361619	4152	282
AM 101	361620	4152	283
AM 102	361621	4152	284
AM 103	361622	4152	285
AM 104	361623	4152	286
AM 105	361624	4152	287
AM 106	361625	4152	288
AM 107	361626	4152	289
AM 108	361627	4152	290
AM 109	361628	4152	291
AM 110	361629	4152	292
AM 111	361630	4152	293
AM 112	361631	4152	294
AM 113	361632	4152	295
AM 114	361633	4152	296
AM 115	361634	4152	297
AM 116	361635	4152	298
AM 117	361636	4152	299
AM 118	361637	4152	300
AM 119	361638	4152	301
AM 120	361639	4152	302
AM 121	361640	4152	303
AM 122	361641	4152	304
AM 123	361642	4152	305
AM 124	361643	4152	306
AM 125	361644	4152	307
AM 126	361645	4152	308
AM 127	361646	4152	309
AM 128	361647	4152	310
AM 129	361648	4152	311
AM 130	361649	4152	312
AM 131	361650	4152	313
AM 132	361651	4152	314
AM 133	361652	4152	315
AM 134	361653	4152	316
AM 135	361654	4152	317
AM 136	361655	4152	318
AM 137	361656	4152	319
AM 138	361657	4152	320
AM 139	361658	4152	321
AM 140	361659	4152	322
AM 141	361660	4152	323
AM 142	361661	4152	324
AM 143	361662	4152	325

PHOENIX, ARIZONA

2006 AUG 22 A 9: 48

RECEIVED  
B.L.M. AZ STATE OFFICE

AM 144	361663	4152	326
AM 145	361664	4152	327
AM 146	361665	4152	328
AM 147	361666	4152	329
AM 148	361667	4152	330
AM 149	361668	4152	331
AM 150	361669	4152	332
AM 151	361670	4152	333
AM 152	361671	4152	334
AM 153	361672	4152	335
AM 154	361673	4152	336
AM 155	361674	4152	337
AM 156	361675	4152	338
AM 157	361676	4152	339
AM 158	361677	4152	340
AM 159	361678	4152	341
AM 160	361679	4152	342
AM 161	361680	4152	343
AM 162	361681	4152	344
AM 163	361682	4152	345
AM 164	361683	4152	346
AM 165	361684	4152	347
AM 166	361685	4152	348
AM 167	361686	4152	349
AM 168	361687	4152	350
AM 169	361688	4152	351
AM 170	361689	4152	352
AM 171	361690	4152	353
AM 172	361691	4152	354
AM 173	361692	4152	355
AM 174	361693	4152	356
AM 175	361694	4152	357
AM 176	361695	4152	358
AM 177	361696	4152	359
AM 178	361697	4152	360
AM 179	361698	4152	361
AM 180	361699	4152	362
AM 181	361700	4152	363
AM 182	361701	4152	364
AM 183	361702	4152	365
AM 184	361703	4152	366
AM 185	361704	4152	367
AM 186	361705	4152	368
AM 187	361706	4152	369
AM 188	361707	4152	370
AM 189	361708	4152	371
AM 190	361709	4152	372
AM 191	361710	4152	373
AM 192	361711	4152	374

PHOENIX, ARIZONA

200b AUG 22 A 9:48

RECEIVED  
B.L.M. AZ STATE OFFICE

AM 193	361712	4152	375
AM 194	361713	4152	376
AM 195	361714	4152	377
AM 196	361715	4152	378
AM 197	361716	4152	379
AM 198	361717	4152	380
AM 199	361718	4152	381
AM 200	361719	4152	382
AM 201	361720	4152	383
AM 202	361721	4152	384
AM 203	361722	4152	385
AM 204	361723	4152	386
AM 205	361724	4152	387
AM 206	361725	4152	388
AM 207	361726	4152	389
AM 208	361727	4152	390
AM 209	361728	4152	391
AM 210	361729	4152	392
AM 211	361730	4152	393
AM 212	361731	4152	394
AM 213	361732	4152	395
AM 214	361733	4152	396
AM 215	361734	4152	397
AM 216	361735	4152	398
AM 246	361736	4152	399
AM 247	361737	4152	400
AM 248	361738	4152	401
AM 249	361739	4152	402
AM 250	361740	4152	403
AM 251	361741	4152	404
AM 252	361742	4152	405
AM 253	361743	4152	406
AM 254	361744	4152	407
AM 255	361745	4152	408
AM 256	361746	4152	409
AM 257	361747	4152	410
AM 258	361748	4152	411
AM 259	361749	4152	412
AM 260	361750	4152	413
AM 261	361751	4152	414
AM 262	361752	4152	415
AM 263	361753	4152	416
AM 264	361754	4152	417
AM 265	365258	4257	894
AM 266	365259	4257	895
AM 267	365260	4257	896
AM 268	365261	4257	897
AM 269	365262	4257	898
AM 270	365263	4257	899

PHOENIX, ARIZONA

2006 AUG 22 A 9:48

RECEIVED  
B.L.M. AZ STATE OFFICE

AM 271	365264	4257	900
AM 272	365265	4257	901
AM 273	365266	4257	902
AM 274	365267	4257	903
AM 275	365268	4257	904
AM 276	365269	4257	905
AM 277	365270	4257	906
AM 278	365271	4257	907
AM 279	365272	4257	908
AM 280	365273	4257	909
AM 281	365274	4257	910
AM 282	365275	4257	911
AM 283	365276	4257	912
AM 284	365277	4257	913
AM 285	365278	4257	914
AM 286	365279	4257	915
AM 287	365280	4257	916
AM 288	365281	4257	917
AM 289	365282	4257	918
AM 290	365283	4257	919
AM 291	365284	4257	920
AM 292	365285	4257	921
AM 293	365286	4257	922
AM 294	365287	4257	923
AM 295	365288	4257	924
AM 296	365289	4257	925
AM 297	365290	4257	926
AM 298	365291	4257	927
AM 299	365292	4257	928
AM 300	365293	4257	929
AM 301	365294	4257	930
AM 302	366483	4285	507
AM 303	366484	4285	508
AM 304	366485	4285	509
AM 305	366486	4285	510
AM 306	366487	4285	511
AM 307	366488	4285	512
AM 308	366489	4285	513
AM 309	366490	4285	514
CE1	366751	4293	962
CE2	366752	4293	963
CE3	366753	4293	964
CE4	366754	4293	956
CE5	366755	4293	957
CE6	366756	4293	958
CE7	366757	4293	959
CE8	366758	4293	960
TH1	366759	4293	961

PHOENIX, ARIZONA

2006 AUG 22 A 9:48

RECEIVED  
B.L.M. AZ STATE OFFICE

**United States Department of the Interior**  
**Bureau of Land Management**  
 BUSINESS & SUPPORT SVCS DIV  
 ONE N CENTRAL AVE  
 PHOENIX, AZ 85004 -2203  
 Phone: (602) 417-9200

Receipt

No: 1341278

<b>Transaction #:</b> 1386500	<b>ENTERED INTO COMPUTER</b>
<b>Date of Transaction:</b> 08/23/2006	SEP 13 2006 PB
<b>CUSTOMER:</b>	CONCENTRIC ENERGY CORP 3537 SPENCERVILLE ROAD SUITE 4 BURTONSVILLE,MD 20866

LINE #	QTY	DESCRIPTION	REMARKS	UNIT PRICE	TOTAL
1	1.00	LOCATABLE MINERALS / MINING CLAIMS-NOT NEW-UNADJUD,ONE AUTH NO. ONLY / MINING CLAIM MONEY RECEIVED (455) <b>CASES: AMC361520/\$36125.00</b>	MAINT 2007 (289)	- n/a -	36125.00
<b>TOTAL:</b>					<b>\$36,125.00</b>

PAYMENT INFORMATION					
1	AMOUNT:	\$36,125.00	POSTMARKED:	08/21/2006	
	TYPE:	CHECK	RECEIVED:	08/22/2006	
	CHECK NO:	1564			
	NAME:	CONCENTRICK ENERGY CORP 6121 LAKESIDE DR STE 260 RENO NV 89511			

REMARKS

This receipt was generated by the automated BLM Collections and Billing System and is a paper representation of a portion of the official electronic record contained therein.

**NOTICE!!**

**These documents have been scanned!**

**Do not place un-scanned documents beneath this notice!**

**Do not remove this notice from this file!**

GPO Jacket No. 560-102  
Print Order 61540  
Rise Business Services, LLC  
Job=AZ15 6/3/2019



Box Number= AZ15113



Claim Begin-End: AMC366751-AMC366759

**5 Miscellaneous**



AZ15113-8

AMC366290-AMC366988

**NO  
DOCUMENTS  
FOUND**

NO DOCUMENTS FOUND  
NO DOCUMENTS FOUND

**NOTICE!!**

**These documents have been scanned!**

**Do not place un-scanned documents beneath this notice!**

**Do not remove this notice from this file!**

GPO Jacket No. 560-102  
Print Order 61540  
Rise Business Services, LLC  
Job=AZ15 6/3/2019



Box Number= AZ15113



Claim Begin-End: AMC366751-AMC366759

**6 Location Notices-Amendments and Supporting Documents**



AZ15113-8

AMC366290-AMC366988



MINING CLAIM STATUS REPORT

STATUS:

MTP CHECKED BY TR

GEO CHECKED BY TR

PRE-ADJ BY TR

FINAL ADJ BY TR

LEAD SERIAL NO. AMC 366751 THROUGH AMC 366759

#	LODE	LOCATION FEE @ \$30 =	\$	_____
#	<u>9</u> PLACER	SERVICE FEE @ \$10 =	\$	_____
#	ASSOCIATION PL	MAINTENANCE FEE @ \$125 =	\$	_____
#	MILL SITE	OVERAGE	\$	_____
#	TUNNEL SITE	SHORTAGE	\$	_____
		OTHER FEES	\$	_____
		TOTAL	\$	<u>1,485<sup>00</sup></u> <i>ok</i>

OVER-THE-COUNTER [ ] MAIL [ ] TIMELY FILED: YES  NO [ ]

LEGAL DESCRIPTION: T 11N R 10W SEC 10,11

T \_\_\_\_\_ R \_\_\_\_\_ SEC \_\_\_\_\_

T \_\_\_\_\_ R \_\_\_\_\_ SEC \_\_\_\_\_

T \_\_\_\_\_ R \_\_\_\_\_ SEC \_\_\_\_\_

JURISDICTION: BLM  FOREST SERVICE [ ] \_\_\_\_\_

WILDERNESS AREA: NO  YES [ ] \_\_\_\_\_

SPLIT ESTATE: SX [ ] PX [ ] SRHA [ ] OTHER [ ] \_\_\_\_\_ N/A [ ]  
PROPER NOTICE FILED IF LOCATED ON SRHA LANDS: YES [ ] NO [ ] N/A [ ]

RECONVEYED MINERALS ON BLM LANDS REQUIRE OPENING ORDERS FROM 1944 TO 1993. OPEN TO ENTRY ON: \_\_\_\_\_ N/A [ ]

SUBJECT TO PL 359: YES [ ] NO [ ]

STATUS; VOID [ ] PARTIALLY VOID [ ] PRIVATE MINERALS [ ]  
WITHDRAWN LANDS [ ] OTHER [ ] \_\_\_\_\_

CLAIMANT ACKNOWLEDGES THAT PORTIONS OF THE FOLLOWING CLAIM(S)/SITE(S): \_\_\_\_\_  
MAY BE VOID OR VOIDABLE. Signature of Claimant: \_\_\_\_\_

COMMENTS: \_\_\_\_\_

*Final Adj TR*  
*5-3-06*

July 28, 2005

Bureau of Land Management  
Arizona State Office  
222 North Central Avenue Suite 101  
Phoenix, AZ  
85004-2203  
602-417-9200  
602-417-9518

Dear Sir:

Enclosed are filing notices and payment for 9 placer claims and an attached map for the 2005 claim year. Also attached is the notice of intent to hold and payment for the 2006 claim year. When you file the claims, please record the AMC serial numbers on the two notices.

If you have any questions please call me at the number below.  
Thank You for your assistance.

Sincerely;

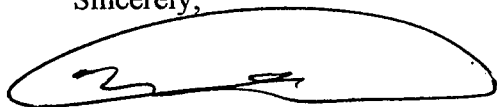

Ralph Kettell  
Concentric Energy Corp.  
2905 Greencastle Road  
Burtonsville Md. 20866  
1-301-236-0807

ARIZONA  
STATE OFFICE  
PHOENIX, ARIZONA

2005 AUG - 1 P 2: 34

RECEIVED  
BUREAU OF  
LAND MANAGEMENT

July 28, 2005

Bureau of Land Management  
Arizona State Office  
222 North Central Avenue Suite 101  
Phoenix, AZ  
85004-2203  
602-417-9200  
602-417-9518

Re: Payment of Maintenance Fees – CE Claims (placer) - 9 Claims

Enclosed with this letter are an Affidavit of Payment of Maintenance Fees and of Intention to Hold Mining Claims and a check for \$1,125.00 representing payment for each of the unpatented placer mining claims shown on Exhibit A. The full names of the claims are shown, but the BLM mining claim serial numbers are left blank so they can be filled in after they have been assigned as part of the attached on the Exhibit A attached to the Affidavit and by this reference incorporated in this letter.

Please return the file-stamped original document to our office so that we may record it with the County.

If you have any questions please call me at the number below.  
Thank You for your assistance.

Sincerely,

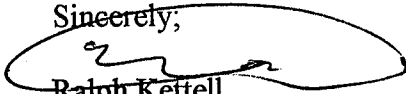

Ralph Kettell  
Concentric Energy Corp.  
2905 Greencastle Road  
Burtonsville Md. 20866  
1-301-236-0807

ARIZONA  
STATE OFFICE  
PHOENIX, ARIZONA

2005 AUG - 1 P 2: 34

RECEIVED  
BUREAU OF  
LAND MANAGEMENT

AMC 366751-366759

Recorded at the request of  
and when recorded please return to:  
Ralph Kettell  
Concentric Energy Corp.  
2905 Greencastle Road  
Burtonsville Md. 20866  
1-301-236-0807

### Notice of Intent to Hold and Affidavit of Payment

The undersigned gives notice as follows:

1. Concentric Energy Corp. is the owner of the Anderson Mine (CE) placer mining claims which are located in Yavapai County, Arizona. The address of the owner is 2905 Greencastle Road, Burtonsville, Md. 20866.
2. The full names of the mining claims and the Bureau of Land Management mining claim serial numbers assigned to the mining claims are described in the exhibit attached to and by this reference incorporated in this Notice.
3. The owner held the claims for the assessment year ending on September 1, 2005 and intends to hold the claims for the assessment year ending on September 1, 2006.
4. The owner paid the federal annual mining claim maintenance fees for the assessment year ending on September 1, 2005 and paid the federal annual mining claim maintenance fees for the assessment year ending on September 1, 2006.

Dated July 26<sup>th</sup>, 2005.

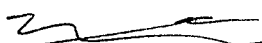
By 

RECEIVED  
BUREAU OF  
LAND MANAGEMENT  
2005 AUG - 1 P 2: 34  
ARIZONA  
STATE OFFICE  
PHOENIX, ARIZONA



**Exhibit A  
Anderson Mine Mining Claims  
Yavapai Counties, Arizona**

Claim Name	Serial #	Book	Page
CE 1			
CE 2			
CE 3			
CE 4			
CE 5			
CE 6			
CE 7			
CE 8			
TH 1			

ARIZONA  
STATE OFFICE  
PHOENIX, ARIZONA

2005 AUG - 1 P 2: 34

RECEIVED  
BUREAU OF  
LAND MANAGEMENT

Recorded at the request of  
and when recorded please return to:  
Ralph Kettell  
Concentric Energy Corp.  
2905 Greencastle Road  
Burtonsville Md. 20866  
1-301-236-0807

### Notice of Intent to File and Affidavit of Payment

The undersigned gives notice as follows:

1. Concentric Energy Corp. is the owner of the Anderson Mine (CE) placer mining claims which are located in Yavapai County, Arizona. The address of the owner is 2905 Greencastle Road, Burtonsville, Md. 20866.
2. The full names of the mining claims and the Bureau of Land Management mining claim serial numbers assigned to the mining claims are described in the exhibit attached to and by this reference incorporated in this Notice.
3. The owner is filing these claims for the assessment year ending on September 1, 2005.
4. The owner has paid the federal filing fees and annual mining claim maintenance fees for the assessment year ending on September 1, 2005 with this notice.

Dated July 26<sup>th</sup>, 2005.

By 

ARIZONA  
STATE OFFICE  
PHOENIX, ARIZONA

2005 AUG - 1 P 2:35

RECEIVED  
BUREAU OF  
LAND MANAGEMENT

STATE OF *Maryland*)  
                                  )ss.  
COUNTY OF *Montgomery*

This Notice of Intent to Hold was acknowledged before me on *June 26<sup>th</sup>*, 2005, by Ralph Kettell.

*Margaret M. Lengua*  
\_\_\_\_\_  
Notary Public  
*Exp. 10.01.08*

RECEIVED  
BUREAU OF  
LAND MANAGEMENT  
2005 AUG - 1 P 2:35  
ARIZONA  
STATE OFFICE  
PHOENIX, ARIZONA



Exhibit A  
Anderson Mine Mining Claims  
Yavapai Counties, Arizona

Claim Name	Serial #	Book	Page
CE 1			
CE 2			
CE 3			
CE 4			
CE 5			
CE 6			
CE 7			
CE 8			
TH 1			

RECEIVED  
BUREAU OF  
LAND MANAGEMENT  
2005 AUG - 1 P 2: 35  
ARIZONA  
STATE OFFICE  
PHOENIX, ARIZONA

NOTICE OF MINING CLAIM LOCATION

ARIZONA  
STATE OFFICE  
PHOENIX, ARIZONA

2005 AUG - 1 P 2: 37

RECEIVED  
BUREAU OF  
LAND MANAGEMENT

- 1. TYPE OF NOTICE:  Location  Amendment  Relocation
- 2. TYPE OF CLAIM OR SITE:  Placer  Lode  Millsite  Tunnel
- 3. The name, address and telephone number of the name(s) to be considered owner(s) is:  
PLEASE PRINT (show additional owners on attached sheet)

Name: CONCENTRIC ENERGY CORP.  
 Address: 2905 GREENCASTLE RD.  
 City/State/Zip Code: BURTONSVILLE MD 20866  
 Telephone Number (include area code): (301) 580-9257

- 4. The name of the claim: CE1
- 5. The date of location is: 5/4/05
- 6. The claim is 1320 feet long and 660 feet wide. The distance from the location monument to each end of the claim is 5 feet in a EAST WEST direction and 0 feet in a NORTH direction, ALONG THE SOUTH END, FROM THE SW. CORN.
- 7. The SW corner of the claim is 5280' NORTH (APPROX) E' 2640' WEST (APPROX) from a survey monument or permanent natural object described as NE. COR. SEC 23 T.11N. R.10W.
- 8. The general course of the claim is from the NORTH to the SOUTH.
- 9. The location of the claim is in Section(s) 11, Quarter Section(s) W 1/2, SW 1/4, SE 1/4, Township(s) 11N., Range(s) 10W, Gila and Salt River Meridian, YAVAPAI County, State of Arizona.
- 10. Is the claim filed under Public Law 359?  yes  no
- 11. Monument types are 2 x 2 x 4 WOOD

AMC 366751

Date 5/4/05 Signature [Signature]  Locator  Agent Only

**MAP OF MINING CLAIM LOCATED**

1. The name of the claim is CE1
2. The SW corner of the claim is 5280' N. E 2640' W. <sup>FROM</sup> 1 feet in a \_\_\_\_\_ direction <sup>to a survey</sup> monument or permanent object as described as N.E. COR. SEC 23 T11N.R10W.
3. The type of location monument is ~~2X~~ PLACER
4. The bearing and distance between the corners of the claim are beginning at the SW. corner of the claim, 1320 feet in a N. direction to the NW. corner, then 660 feet in a E. direction to the NE. corner, then 1320 feet in a S. direction to the SE. corner, then 660 feet in a W. direction to the point of beginning.
5. Please indicate the distance and bearings between claim corners and a recognized survey monument or landmark. Indicate the distance from the location monument to each end of the claim.

**MAP**

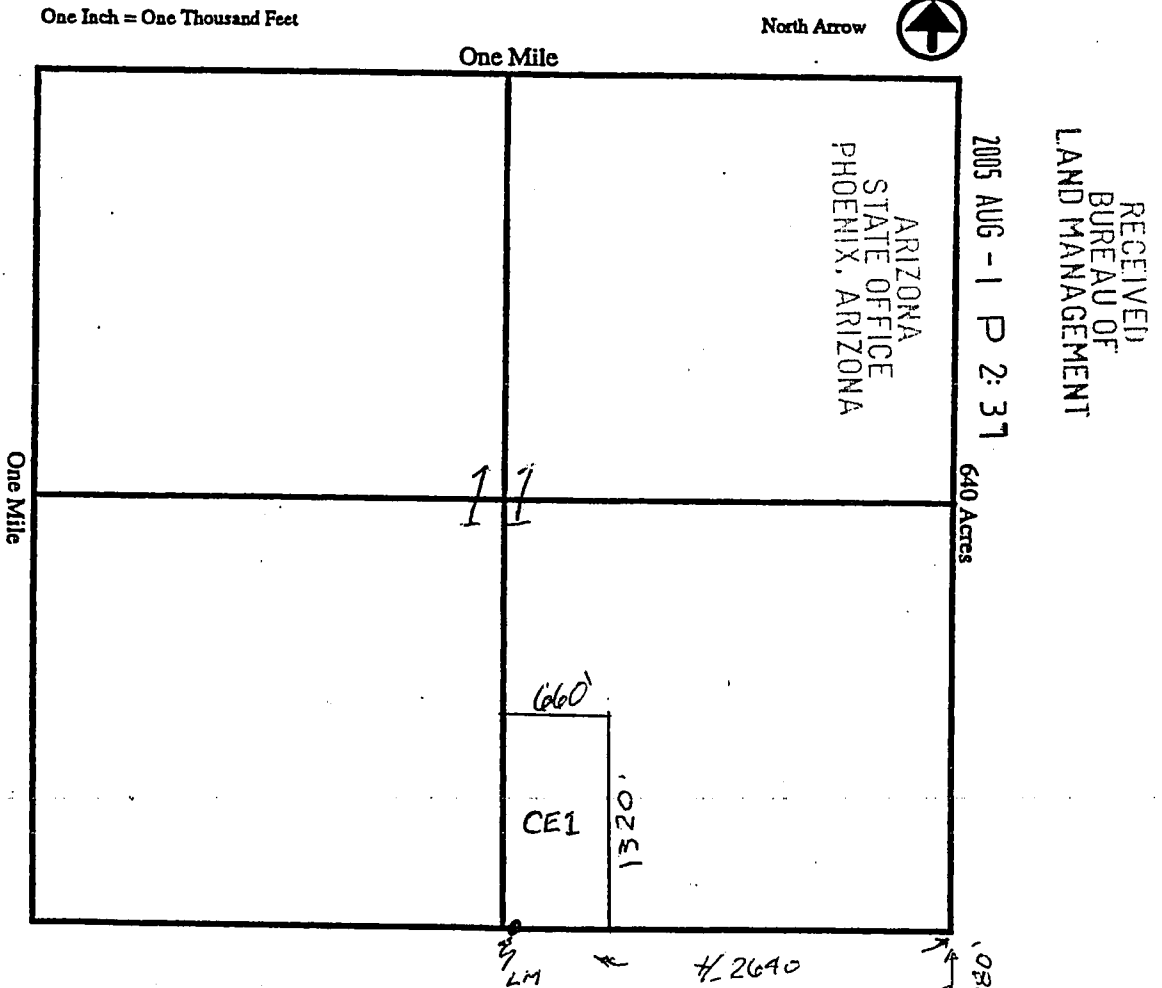

Section 11, Quarter Section SE, Range 10W  
 Township 11N, G&SR Meridian, YAVAPAI County, Arizona.

Date 5/4/05

Signature *[Handwritten Signature]*

Claim Name : CEI

Page 3/3

Addendum to Notice of Mining Claim Location

**Note: This placer claim has been located for the purpose of appropriating all placer minerals that may lie within the boundaries of the claim. This location is NOT intended as an abandonment of the pre-existing lode claim location.**

ARIZONA  
STATE OFFICE  
PHOENIX, ARIZONA

2005 AUG - 1 P 2: 37

RECEIVED  
BUREAU OF  
LAND MANAGEMENT

ANC 366751

NOTICE OF MINING CLAIM LOCATION

RECEIVED  
BUREAU OF  
LAND MANAGEMENT  
2005 AUG - 1 P 2: 37  
ARIZONA  
STATE OFFICE  
PHOENIX, ARIZONA

ANC 366752

- 1. TYPE OF NOTICE:  Location  Amendment  Relocation
- 2. TYPE OF CLAIM OR SITE:  Placer  Lode  Millsite  Tunnel
- 3. The name, address and telephone number of the name(s) to be considered owner(s) is:  
**PLEASE PRINT** (show additional owners on attached sheet)

Name: CONCENTRIC ENERGY CORP.  
 Address: 2905 GREENCASTLE Rd.  
 City/State/Zip Code: BURTONSVILLE, MD 20866  
 Telephone Number (include area code): (301) - (580) - 9257

4. The name of the claim: CE 2

5. The date of location is: 5/4/05

6. The claim is 660 feet long and 1320 feet wide. The distance from the location monument to each end of the claim is 5 feet in a EAST. direction and 0 feet in a N. direction, ALONG THE SOUTH LINE, FROM THE SE. COR. OF THE CLAIM

7. The SE. corner of the claim is APPROX 5280' N. & APPROX 2640' W. from a survey monument or permanent natural object described as NE. COR. SEC 23 T11N. R10W.

8. The general course of the claim is from the SOUTH to the NORTH.

9. The location of the claim is in Section(s) 11, Quarter Section(s) S 1/2, SE 1/4, SW 1/4, Township(s) 11N, Range(s) 10W., Gila and Salt River Meridian, YAVAPAI County, State of Arizona.

10. Is the claim filed under Public Law 359?  yes  no

11. Monument types are 2X2 X 4 WOOD

Date 5/4/05 Signature [Signature]  Locator  Agent Only

**OF MINING CLAIM LOCATI**

- The name of the claim is CE2
- The SE corner of the claim is 5280 1/2 feet in a N. E 2640 1/2 W. direction <sup>FROM</sup> to a survey monument or permanent object as described as NE SEC 23 T1N R10W.
- The type of location monument is PLACER
- The bearing and distance between the corners of the claim are beginning at the SE. corner of the claim, 1320 feet in a W. direction to the SW. corner, then 660 feet in a N. direction to the NW. corner, then 1320 feet in a E direction to the NE. corner, then 660 feet in a S direction to the point of beginning.
- Please indicate the distance and bearings between claim corners and a recognized survey monument or landmark. Indicate the distance from the location monument to each end of the claim.

**MAP**

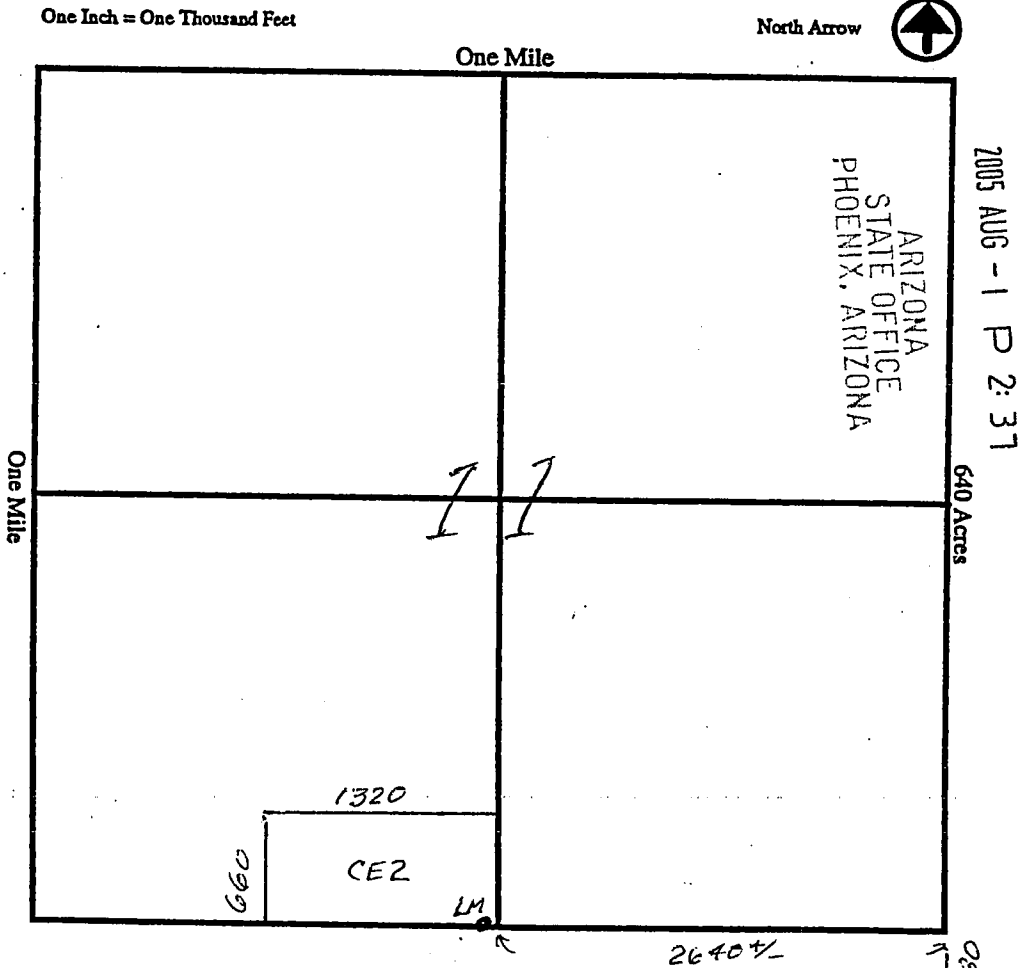

Section 11, Quarter Section SW, Range 10W  
 Township 11N., G&SR Meridian, YAVAPAI County, Arizona. NE SEC 23

Date 5/4/05 Signature [Handwritten Signature]

Claim Name : CE2

Page 3/3

Addendum to Notice of Mining Claim Location

**Note: This placer claim has been located for the purpose of appropriating all placer minerals that may lie within the boundaries of the claim. This location is NOT intended as an abandonment of the pre-existing lode claim location.**

RECEIVED  
BUREAU OF  
LAND MANAGEMENT  
2005 AUG - 1 P 2: 37  
ARIZONA  
STATE OFFICE  
PHOENIX, ARIZONA

ANL 366752

NOTICE OF MINING CLAIM LOCATION

RECEIVED  
BUREAU OF  
LAND MANAGEMENT  
2005 AUG - 1 P 2:37  
ARIZONA  
STATE OFFICE  
PHOENIX, ARIZONA

- 1. TYPE OF NOTICE:  Location  Amendment  Relocation
- 2. TYPE OF CLAIM OR SITE:  Placer  Lode  Millsite  Tunnel site
- 3. The name, address and telephone number of the name(s) to be considered owner(s) is: **PLEASE PRINT** (show additional owners on attached sheet)

Name: CONCENTRIC ENERGY CORP.  
 Address: 2905 GREENCASTLE Rd.  
 City/State/Zip Code: BURTONSVILLE MD. 20866  
 Telephone Number (include area code): BOI-580-9257

4. The name of the claim: CE3

5. The date of location is: 5/4/05

6. The claim is 1320 feet long and 660 feet wide. The distance from the location monument to each end of the claim is 5 feet in a E. direction and 0 feet in a N. direction. ALONG THE SOUTH LINE, FROM THE SE CORNER.

7. The SE. corner of the claim is APPROX. 5940' N. E' APPROX 2640' W. from a survey monument or permanent natural object described as NE. COR. SEC 23 T11N. R10W.

8. The general course of the claim is from the EAST to the WEST.

9. The location of the claim is in Section(s) 11, Quarter Section(s) N<sup>1</sup>/<sub>2</sub>, SE<sup>1</sup>/<sub>4</sub>, SW<sup>1</sup>/<sub>4</sub>, Township(s) 11N., Range(s) 10W., Gila and Salt River Meridian, YAVAPAI County, State of Arizona.

10. Is the claim filed under Public Law 359?  yes  no

11. Monument types are 2X2X4 WOOD

Date 5/4/05 Signature [Signature]  Locator  Agent Only

AMC 366753



**OF MINING CLAIM LOCATI**

- The name of the claim is CE3
- The SE corner of the claim is 5940'4" N & 2640'4" W. feet in a FROM A direction to a survey monument or permanent object as described as NE COR. SEC 23 T11N.R10W?
- The type of location monument is PLACER
- The bearing and distance between the corners of the claim are beginning at the SE. corner of the claim, 1320 feet in a W. direction to the SW. corner, then 660 feet in a N. direction to the NW. corner, then 1320 feet in a E. direction to the NE. corner, then 660 feet in a S. direction to the point of beginning.
- Please indicate the distance and bearings between claim corners and a recognized survey monument or landmark. Indicate the distance from the location monument to each end of the claim.

**MAP**

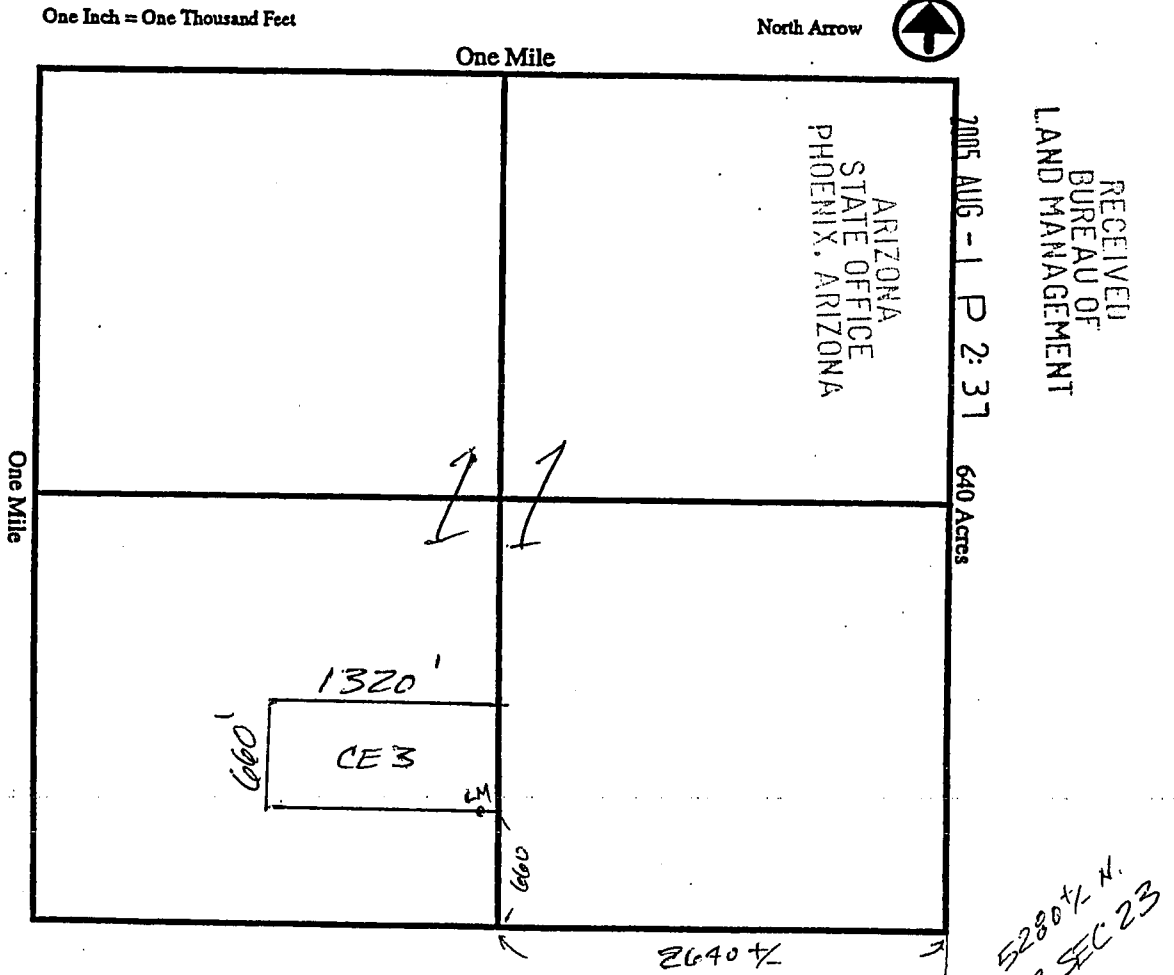

Section 11, Quarter Section SW, Range 10W, Township 11N., G&SR Meridian, YAVAPAI County, Arizona.

Date 5/4/05

Signature [Handwritten Signature]

Claim Name : CE3

Page 3/3

Addendum to Notice of Mining Claim Location

**Note: This placer claim has been located for the purpose of appropriating all placer minerals that may lie within the boundaries of the claim. This location is NOT intended as an abandonment of the pre-existing lode claim location.**

ARIZONA  
STATE OFFICE  
PHOENIX, ARIZONA

2005 AUG - 1 P 2: 37

RECEIVED  
BUREAU OF  
LAND MANAGEMENT

ANL 366753

NOTICE OF MINING CLAIM LOCATION

ARIZONA  
STATE OFFICE  
PHOENIX, ARIZONA

2005 AUG - 1 P 2:37

RECEIVED  
BUREAU OF  
LAND MANAGEMENT

- 1. TYPE OF NOTICE:  Location  Amendment  Relocation
- 2. TYPE OF CLAIM OR SITE:  Placer  Lode  Millsite  Tunnel site
- 3. The name, address and telephone number of the name(s) to be considered owner(s) is:  
PLEASE PRINT (show additional owners on attached sheet)  
Name: CONCENTRIC ENERGY CORP.  
Address: 2905 GREENCASTLE RD.  
City/State/Zip Code: BURTONSVILLE, MD 20866  
Telephone Number (include area code): (301) 580 9257
- 4. The name of the claim: CE 4
- 5. The date of location is: 5/4/05
- 6. The claim is 1320 feet long and 660 feet wide. The distance from the location monument to each end of the claim is 5 feet in a EAST direction and 0 feet in a N. direction. ALONG THE SOUTH LINE FROM THE SE. CORNER OF THE CLAIM.
- 7. The SE. corner of the claim is ±6600 FT. NORTH ± 2640 1/2 FT. WEST from a survey monument or permanent natural object described as NE COR SEC 23 TIN. R10W.
- 8. The general course of the claim is from the E. to the W.
- 9. The location of the claim is in Section(s) 11, Quarter Section(s) S 1/2, NE 1/4, SW 1/4, Township(s) 11N, Range(s) 10W., Gila and Salt River Meridian, YAVAPAI County, State of Arizona.
- 10. Is the claim filed under Public Law 359?  yes  no
- 11. Monument types are 2X2X4 WOOD

AMC 366754

Date 5/4/05 Signature [Signature]  Locator  Agent Only

**MAP OF MINING CLAIM LOCATION**

- The name of the claim is CE 4
- The SE. corner of the claim is 660 FT. 1/2 N. & 2640 FT. 1/2 W. FROM A direction to a survey monument or permanent object as described as N.E. COR. SEC. 23 T11N. R10W.
- The type of location monument is PLACER
- The bearing and distance between the corners of the claim are beginning at the SE. corner of the claim, 1320 feet in a W. direction to the SW. corner, then 660 feet in a N. direction to the NW. corner, then 1320 feet in a E. direction to the NE corner, then 660 feet in a S. direction to the point of beginning.
- Please indicate the distance and bearings between claim corners and a recognized survey monument or landmark. Indicate the distance from the location monument to each end of the claim.

**MAP**

One Inch = One Thousand Feet

North Arrow



One Mile

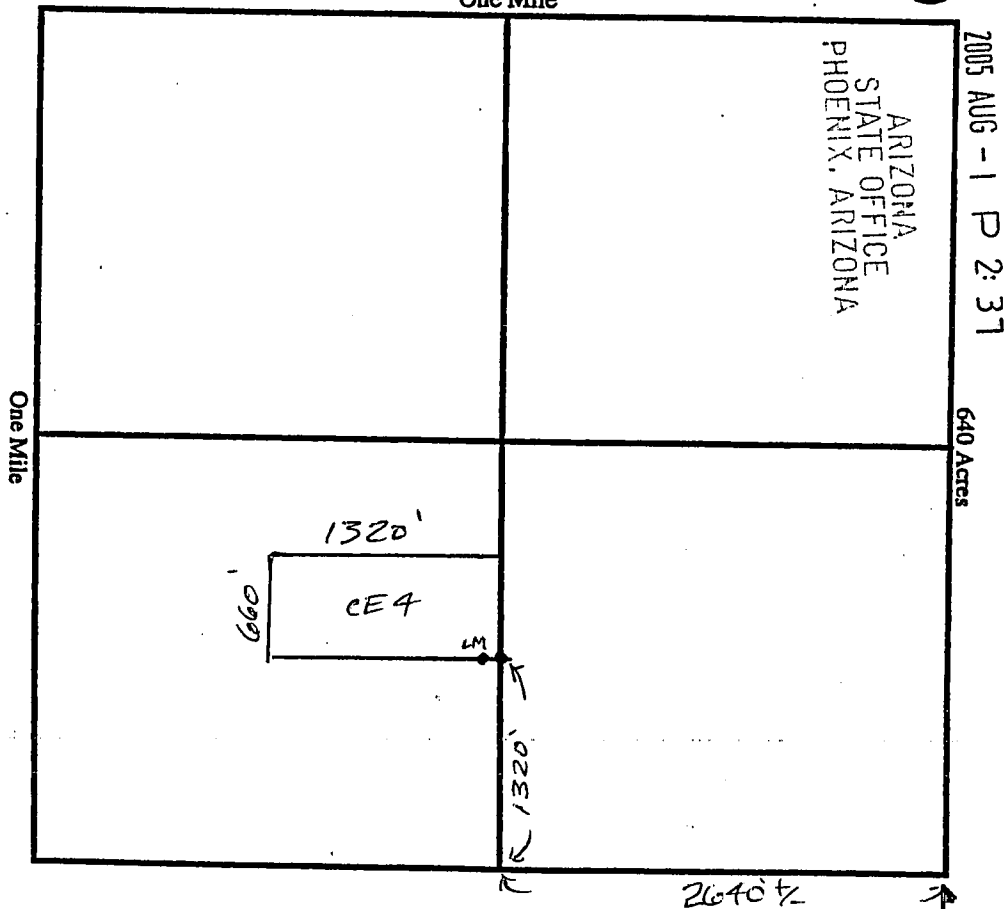

RECEIVED  
BUREAU OF  
LAND MANAGEMENT

2005 AUG - 1 P 2: 31

640 Acres

One Mile

Section 11, Quarter Section SW, Range 10W.  
Township 11N., G&SR Meridian, YAVAPAI County, Arizona

Date 5/4/05

Signature [Handwritten Signature]

T11N  
R10W  
NE COR SEC 23

Claim Name : CE4

Page 3/3

Addendum to Notice of Mining Claim Location

**Note: This placer claim has been located for the purpose of appropriating all placer minerals that may lie within the boundaries of the claim. This location is NOT intended as an abandonment of the pre-existing lode claim location.**

AMC 366754

RECEIVED  
BUREAU OF  
LAND MANAGEMENT

2005 AUG - 1 P 2: 37

ARIZONA  
STATE OFFICE  
PHOENIX, ARIZONA

NOTICE OF MINING CLAIM LOCATION

1. TYPE OF NOTICE:  Location  Amendment  Relocation

2. TYPE OF CLAIM OR SITE:  Placer  Lode  Millsite  Tunnel site

3. The name, address and telephone number of the name(s) to be considered owner(s) is: PLEASE PRINT (show additional owners on attached sheet)

Name: CONCENTRIC ENERGY CORP.  
Address: 2905 GREENCASTLE RD.  
City/State/Zip Code: BURTONSVILLE MD 20866  
Telephone Number (include area code): (301) - 580 - 9257

RECEIVED  
BUREAU OF  
LAND MANAGEMENT  
2005 AUG - 1 P 2: 36  
ARIZONA  
STATE OFFICE  
PHOENIX, ARIZONA

4. The name of the claim: CE 5

5. The date of location is: 5/4/05

6. The claim is 1320 feet long and 660 feet wide. The distance from the location monument to each end of the claim is 5 feet in a E. direction and 0 feet in a N. direction. ALONG THE SOUTH LINE, FROM THE SE CORNER OF THE CLAIM.

7. The SE. corner of the claim is 6600 FT. +/- N. E 3900 FT. +/- W.

from a survey monument or permanent natural object described as SEC 23, NE COR. TIN RICK.

8. The general course of the claim is from the EAST to the WEST.

9. The location of the claim is in Section(s) 11, Quarter Section(s) 5 1/2, NW 1/4, SW 1/4, Township(s) 11 N., Range(s) 10 W., Gila and Salt River Meridian, YAVAPAI County, State of Arizona.

10. Is the claim filed under Public Law 359?  yes  no

11. Monument types are 2x2x4 WOOD

Date 5/4/05 Signature [Signature]  Locator  Agent Only

P OF MINING CLAIM LOCAT

- The name of the claim is CE5
- The SE corner of the claim is 6600 FT. 1/4 N. & 3960 FT. 1/4 W feet in a FROM A direction to a survey monument or permanent object as described as NE. COR. SEC. 23 T11N. R10W
- The type of location monument is PLACER
- The bearing and distance between the corners of the claim are beginning at the SE. corner of the claim, 1320 feet in a W. direction to the SW. corner, then 660 feet in a NORTH direction to the NW. corner, then 1320 feet in a EAST. direction to the NE. corner, then 660 feet in a SOUTH direction to the point of beginning.
- Please indicate the distance and bearings between claim corners and a recognized survey monument or landmark. Indicate the distance from the location monument to each end of the claim.

MAP

One Inch = One Thousand Feet

North Arrow

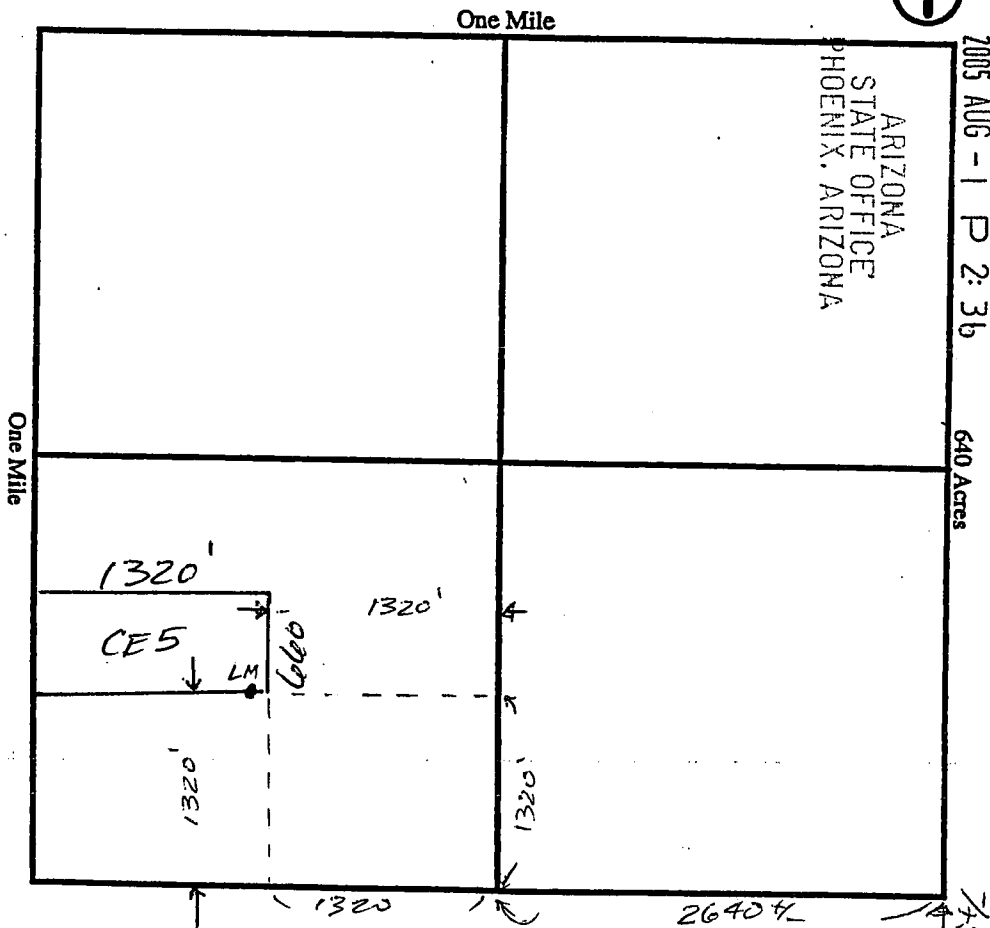

Section 11 Quarter Section SW Range 10N  
 Township 11N G&SR Meridian, YAVAPAI County, Arizona.

Date 5/4/05

Signature [Signature]

740825  
 NE COR. SEC 23

Claim Name :     CES    

Page 3/3

Addendum to Notice of Mining Claim Location

**Note: This placer claim has been located for the purpose of appropriating all placer minerals that may lie within the boundaries of the claim. This location is NOT intended as an abandonment of the pre-existing lode claim location.**

RECEIVED  
BUREAU OF  
LAND MANAGEMENT  
2005 AUG - 1 P 2: 36  
ARIZONA  
STATE OFFICE  
PHOENIX, ARIZONA

AMC 366755



NOTICE OF MINING CLAIM LOCATION

1. TYPE OF NOTICE:  Location  Amendment  Relocation

2. TYPE OF CLAIM OR SITE:  Placer  Lode  Millsite  Tunnel site

3. The name, address and telephone number of the name(s) to be considered owner(s) is: PLEASE PRINT (show additional owners on attached sheet)

Name: CONCENTRIC ENERGY CORP.  
Address: 2905 GREENCASTLE RD.  
City/State/Zip Code: BURTONSVILLE MD 20866  
Telephone Number (include area code): (301) 580 9257

RECEIVED  
BUREAU OF  
LAND MANAGEMENT  
2005 AUG - 1 P 2:36  
ARIZONA  
STATE OFFICE  
PHOENIX, ARIZONA

AMG 366756

4. The name of the claim: CEG

5. The date of location is: 5/4/05

6. The claim is 1320 feet long and 660 feet wide. The distance from the location monument to each end of the claim is 250 feet in a N. direction and 0 feet in a W. direction. ALONG THE EAST LINE, FROM THE SE. COR. OF THE CLAIM.

7. The SE. corner of the claim is 5940 FT. +/- N. & 3960 FT. +/- from a survey monument or permanent natural object described as NE COR. SEC 23 TUN. RIDGE.

8. The general course of the claim is from the EAST to the WEST.

9. The location of the claim is in Section(s) 11, Quarter Section(s) N1/2, SW1/4, SW1/4, Township(s) 11N., Range(s) 10W., Gila and Salt River Meridian, YAVAPAI County, State of Arizona.

10. Is the claim filed under Public Law 359?  yes  no

11. Monument types are 2x2x4 WOOD

Date 5/4/05 Signature [Signature]  Locator  Agent Only

**MAP OF MINING CLAIM LOCALITY**

- The name of the claim is CEG
- The SE. corner of the claim is 5940 FT 1/2 N. & 3960 FT 1/2 W. FROM A feet in a \_\_\_\_\_ direction to a survey monument or permanent object as described as NE COR. SEC 23, T11N. R10W.
- The type of location monument is PLACER
- The bearing and distance between the corners of the claim are beginning at the SE. corner of the claim, 1320 feet in a W. direction to the SW. corner, then 660 feet in a N. direction to the NW. corner, then 1320 feet in a E. direction to the NE. corner, then 660 feet in a S. direction to the point of beginning.
- Please indicate the distance and bearings between claim corners and a recognized survey monument or landmark. Indicate the distance from the location monument to each end of the claim.

**MAP**

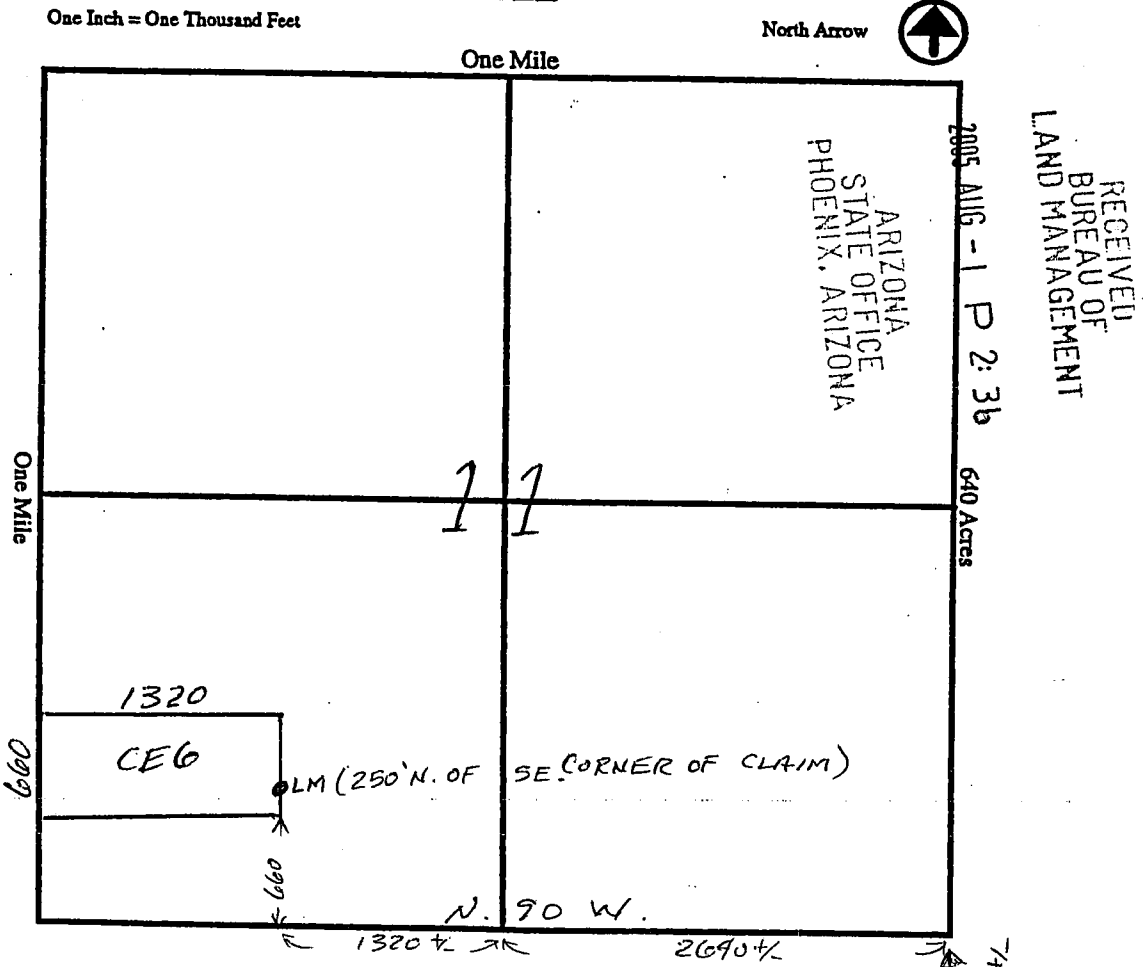

Section 11, Quarter Section SW, Range 10N.  
 Township 11 N., G&SR Meridian, YAVAPAI County, Arizona

Date 5/4/05 Signature [Handwritten Signature]

Claim Name : CEG

Page 3/3

Addendum to Notice of Mining Claim Location

**Note: This placer claim has been located for the purpose of appropriating all placer minerals that may lie within the boundaries of the claim. This location is NOT intended as an abandonment of the pre-existing lode claim location.**

AMG 366756

RECEIVED  
BUREAU OF  
LAND MANAGEMENT  
2005 AUG - 1 P 2:36  
ARIZONA  
STATE OFFICE  
PHOENIX, ARIZONA

NOTICE OF MINING CLAIM LOCATION

- 1. TYPE OF NOTICE:  Location  Amendment  Relocation
- 2. TYPE OF CLAIM OR SITE:  Placer  Lode  Millsite  Tunnelsite

3. The name, address and telephone number of the name(s) to be considered owner(s) is: PLEASE PRINT (show additional owners on attached sheet)

Name: CONCENTRIC ENERGY CORP.  
 Address: 2905 GREENCASTLE Rd.  
 City/State/Zip Code: BURTONSVILLE MD. 20866  
 Telephone Number (include area code): (301) 580-9257

RECEIVED  
 BUREAU OF  
 LAND MANAGEMENT  
 2005 AUG - 1 P 2:36  
 ARIZONA  
 STATE OFFICE  
 PHOENIX, ARIZONA

- 4. The name of the claim: CE7
- 5. The date of location is: 5/8/05
- 6. The claim is 1320 feet long and 660 feet wide. The distance from the location monument to each end of the claim is 5 feet in a EAST direction and 0 feet in a NORTH direction. ALONG THE SOUTH LINE, FROM THE SE CORNER OF THE CLAIM
- 7. The SE corner of the claim is 7260 FT - NORTH & 3960 FT - WEST from a survey monument or permanent natural object described as N.E. COR SEC 23 T11N. R10W.
- 8. The general course of the claim is from the EAST to the WEST.
- 9. The location of the claim is in Section(s) 11, Quarter Section(s) N 1/2, NW 1/4, SW 1/4, Township(s) 11N., Range(s) 10W, Gila and Salt River Meridian, YAVAPAI County, State of Arizona.
- 10. Is the claim filed under Public Law 359?  yes  no
- 11. Monument types are 2X2X4 WOOD

ANJ 366757

Date 5/8/05 Signature [Signature]  Locator  Agent Only

**MAP OF MINING CLAIM LOCATED**

- The name of the claim is CE7
- The SE corner of the claim is 7260 FT. 1/4 N & 3960 FT. 1/4 W. feet in a From direction to a survey monument or permanent object as described as NE. COR. SEC 23 T11N. R10W
- The type of location monument is PLACER
- The bearing and distance between the corners of the claim are beginning at the SE corner of the claim, 1320 feet in a W direction to the SW corner, then 660 feet in a N. 60° E direction to the NW corner, then 1320 feet in a WEST direction to the NE corner, then 660 feet in a S direction to the point of beginning.
- Please indicate the distance and bearings between claim corners and a recognized survey monument or landmark. Indicate the distance from the location monument to each end of the claim.

**MAP**

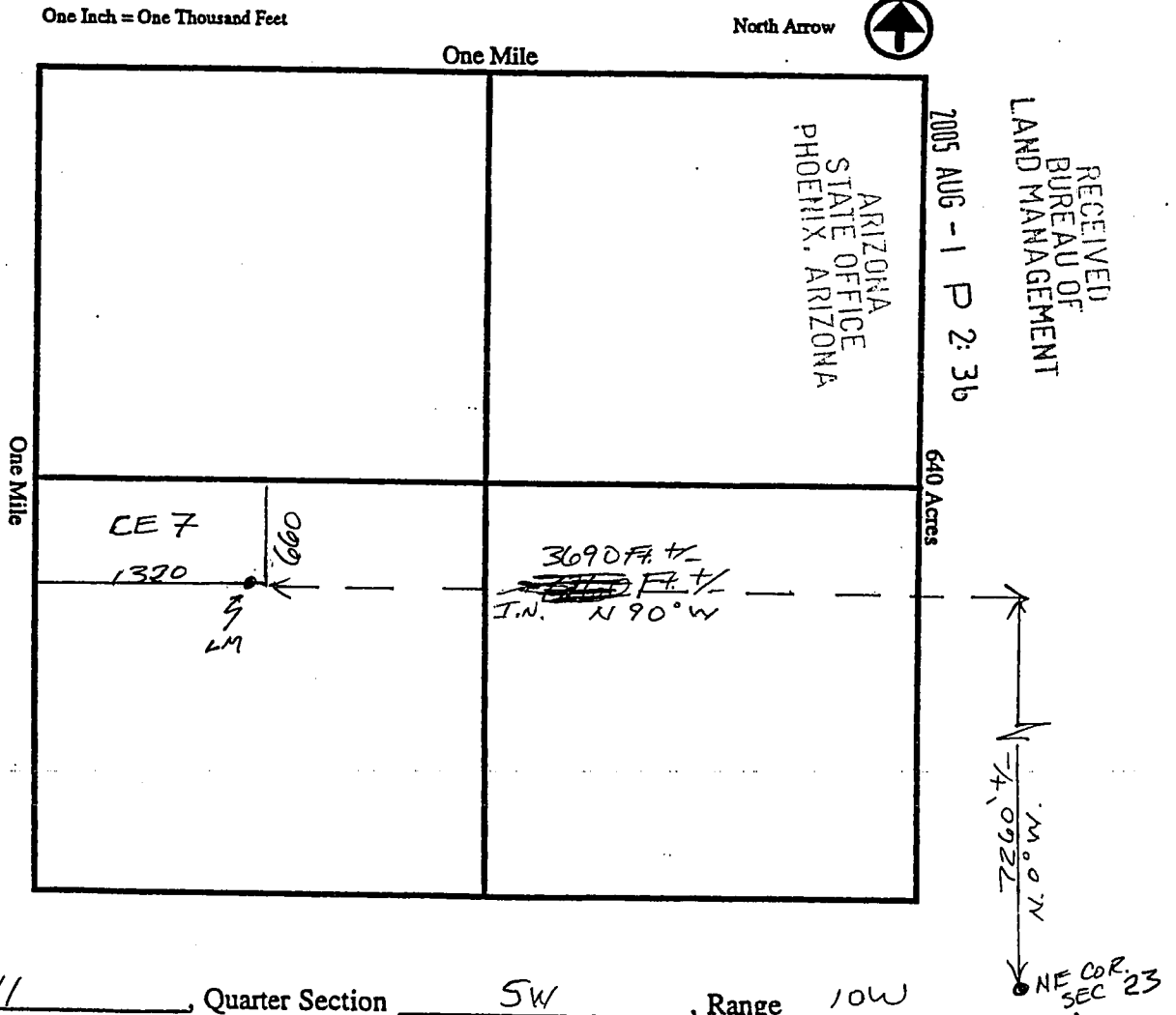

Section 11, Quarter Section SW, Range 10W  
 Township 11N., G&SR Meridian, YAVAPAI County, Arizona.

Date 5/8/05

Signature [Signature]

Claim Name : CE7

Page 3/3

Addendum to Notice of Mining Claim Location

**Note: This placer claim has been located for the purpose of appropriating all placer minerals that may lie within the boundaries of the claim. This location is NOT intended as an abandonment of the pre-existing lode claim location.**

RECEIVED  
BUREAU OF  
LAND MANAGEMENT  
2005 AUG - 1 P 2: 36  
ARIZONA  
STATE OFFICE  
PHOENIX, ARIZONA

AMC 366757

NOTICE OF MINING CLAIM LOCATION

RECEIVED  
BUREAU OF  
LAND MANAGEMENT  
2005 AUG - 1 P 2:36  
ARIZONA  
STATE OFFICE  
PHOENIX, ARIZONA

- 1. TYPE OF NOTICE:  Location  Amendment  Relocation
- 2. TYPE OF CLAIM OR SITE:  Placer  Lode  Millsite  Tunnel
- 3. The name, address and telephone number of the name(s) to be considered owner(s) is:  
PLEASE PRINT (show additional owners on attached sheet)

Name: CONCENTRIC ENERGY CORP.  
 Address: 2905 GREENCASTLE RD.  
 City/State/Zip Code: BURTONSVILLE MD. 20866  
 Telephone Number (include area code): (301) 580-9257

4. The name of the claim: CE8

5. The date of location is: 5/8/05

6. The claim is 1320 feet long and 660 feet wide. The distance from the location monument to each end of the claim is 5 feet in a E. direction and 0 feet in a N. direction. ALONG THE SOUTH LINE, FROM THE SE CORNER OF THE CLAIM

7. The SE. corner of the claim is 6600' +/- N. & 5280' +/- W.

from a survey monument or permanent natural object described as NE. CORNER SEC. 23 T11N. R10W.

8. The general course of the claim is from the E. to the W.

9. The location of the claim is in Section(s) 10, Quarter Section(s) S 1/2, NE 1/4, SE 1/4, Township(s) 11N., Range(s) 10W., Gila and Salt River Meridian, YAVAPAI County, State of Arizona.

10. Is the claim filed under Public Law 359?  yes  no

11. Monument types are 2X2X4 WOOD

Date 5/8/05 Signature [Signature]  Locator  Agent Only

AMC 366758

# OF MINING CLAIM LOCATE

1. The name of the claim is CEB
2. The SE corner of the claim is 6600' +/- N & 5280' +/- W. feet in a FROM direction ~~to a survey monument or permanent object as described as~~ NE SEC 23 T11N R10W
3. The type of location monument is PLAER
4. The bearing and distance between the corners of the claim are beginning at the SE corner of the claim, 1320 feet in a W. direction to the SW corner, then 660 feet in a N. direction to the NW corner, then 1320 feet in a E. direction to the NE corner, then 660 feet in a S. direction to the point of beginning.
5. Please indicate the distance and bearings between claim corners and a recognized survey monument or landmark. Indicate the distance from the location monument to each end of the claim.

## MAP

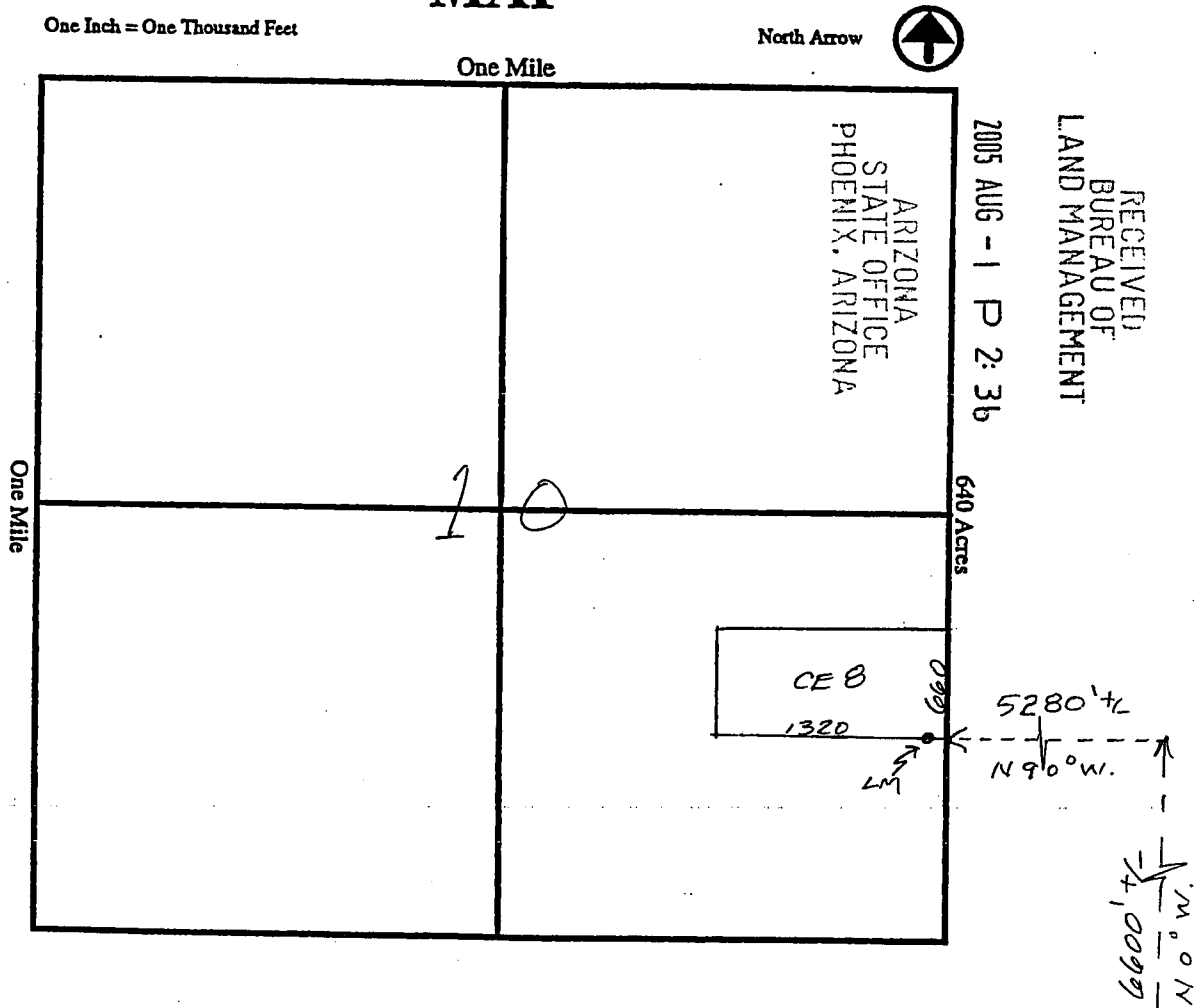

Section 10, Quarter Section SE, Range 10W  
 Township T11N, G&SR Meridian, TANAPAI County, Arizona.

Date 5/8/05 Signature [Signature]



Claim Name : CE8

Page 3/3

Addendum to Notice of Mining Claim Location

**Note: This placer claim has been located for the purpose of appropriating all placer minerals that may lie within the boundaries of the claim. This location is NOT intended as an abandonment of the pre-existing lode claim location.**

ARIZONA  
STATE OFFICE  
PHOENIX, ARIZONA

2005 AUG - 1 P 2: 36

RECEIVED  
BUREAU OF  
LAND MANAGEMENT

FILE 366758

NOTICE OF MINING CLAIM LOCATION

1. TYPE OF NOTICE:  Location  Amendment  Relocation

2. TYPE OF CLAIM OR SITE:  Placer  Lode  Millsite  Tunnel site

3. The name, address and telephone number of the name(s) to be considered owner(s) is: PLEASE PRINT (show additional owners on attached sheet)

Name: CONCENTRIC ENERGY CORP.  
Address: 2905 GREENCASTLE RD.  
City/State/Zip Code: BURTONSVILLE MD. 20866  
Telephone Number (include area code): (301) 580-9257

4. The name of the claim: TH1

5. The date of location is: 5/8/05

6. The claim is 1320 feet long and 660 feet wide. The distance from the location monument to each end of the claim is 5 feet in a EAST direction and \_\_\_\_\_ feet in a \_\_\_\_\_ direction. ALONG THE SOUTH LINE, FROM THE SE CORNER OF THE CLAIM.

7. The SE. corner of the claim is 7260 Ft. N. & 5280 Ft. W. from a survey monument or permanent natural object described as NE. COR. SEC 23 T11N. R10W.

8. The general course of the claim is from the EAST to the WEST.

9. The location of the claim is in Section(s) 10, Quarter Section(s) N 1/2, NE 1/4, SE 1/4, Township(s) 11N, Range(s) 10W, Gila and Salt River Meridian, YAVAPAI County, State of Arizona.

10. Is the claim filed under Public Law 359?  yes  no

11. Monument types are 2X2X4 WOOD

RECEIVED  
BUREAU OF  
LAND MANAGEMENT  
2005 AUG - 1 P 2:36  
ARIZONA  
STATE OFFICE  
PHOENIX, ARIZONA

ANC 366759

Date 5/8/05 Signature [Signature]  Locator  Agent Only

**OF MINING CLAIM LOCAT**

- The name of the claim is TH1
- The SE corner of the claim is 7260 Ft 1/4 N F 5280 1/4 W. feet in a From direction to a survey monument or permanent object as described as NE. COR. SEC 23
- The type of location monument is PLACER
- The bearing and distance between the corners of the claim are beginning at the SE corner of the claim, 1320 feet in a WEST direction to the SW. corner, then 660 feet in a 1/4 N. NORTH direction to the NW. corner, then 1320 feet in a E. direction to the NE. corner, then 660 feet in a S. direction to the point of beginning.
- Please indicate the distance and bearings between claim corners and a recognized survey monument or landmark. Indicate the distance from the location monument to each end of the claim.

**MAP**

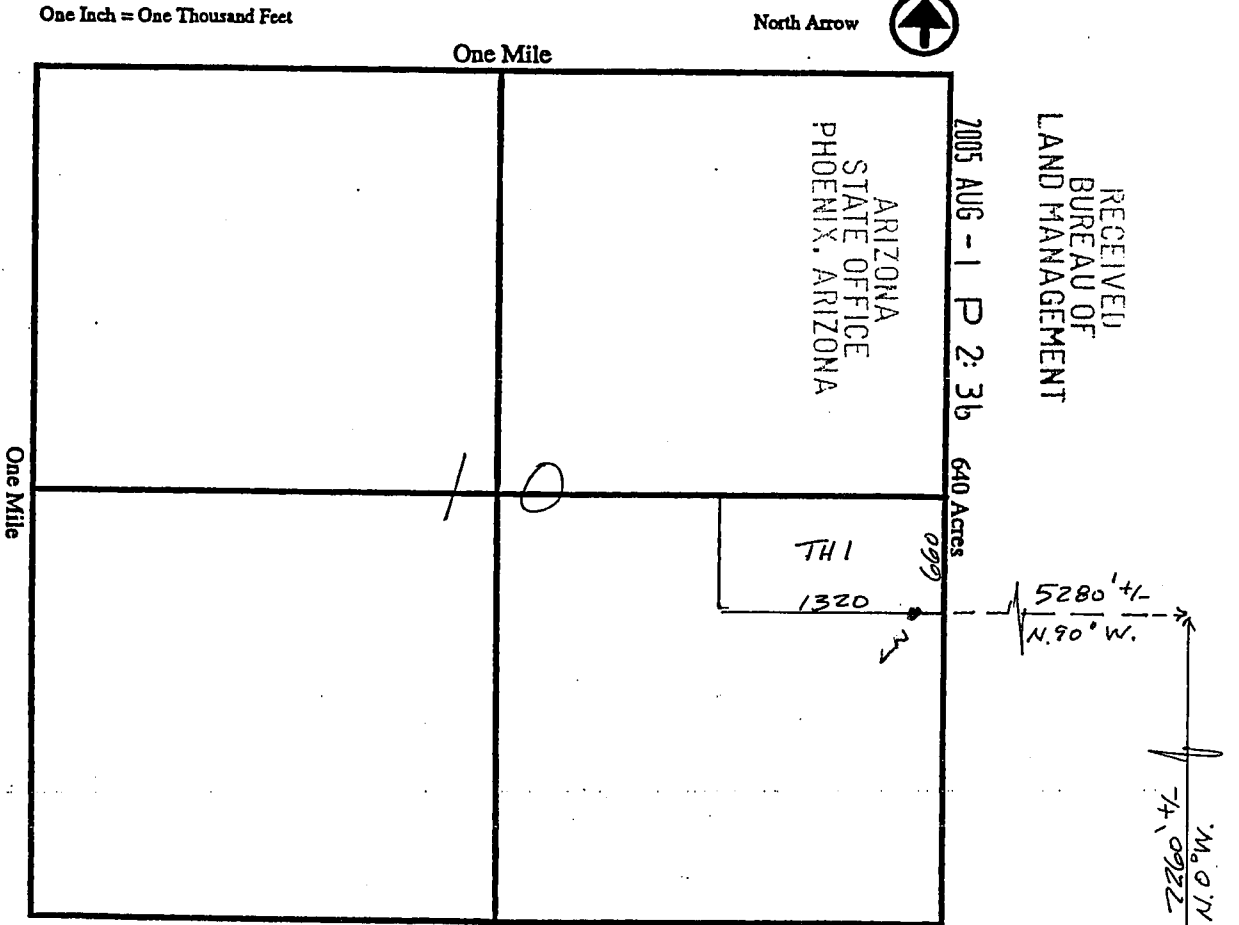

Section 10, Quarter Section SE, Range 10W  
 Township 11N, G&SR Meridian, YAVAPAI County, Arizona.

Date 5/8/05 Signature [Signature]

Claim Name : TH1

Page 3/3

Addendum to Notice of Mining Claim Location

**Note: This placer claim has been located for the purpose of appropriating all placer minerals that may lie within the boundaries of the claim. This location is NOT intended as an abandonment of the pre-existing lode claim location.**

ANG 366759

RECEIVED  
BUREAU OF  
LAND MANAGEMENT

2005 AUG - 1 P 2: 36

ARIZONA  
STATE OFFICE  
PHOENIX, ARIZONA

# LOCATION OF PLACER CLAIMS FOR CONCENTRIC ENERGY CORPORATION SECTIONS 10&11 T11N,R10W, G&SRM YAVAPAI,CO.ARIZONA

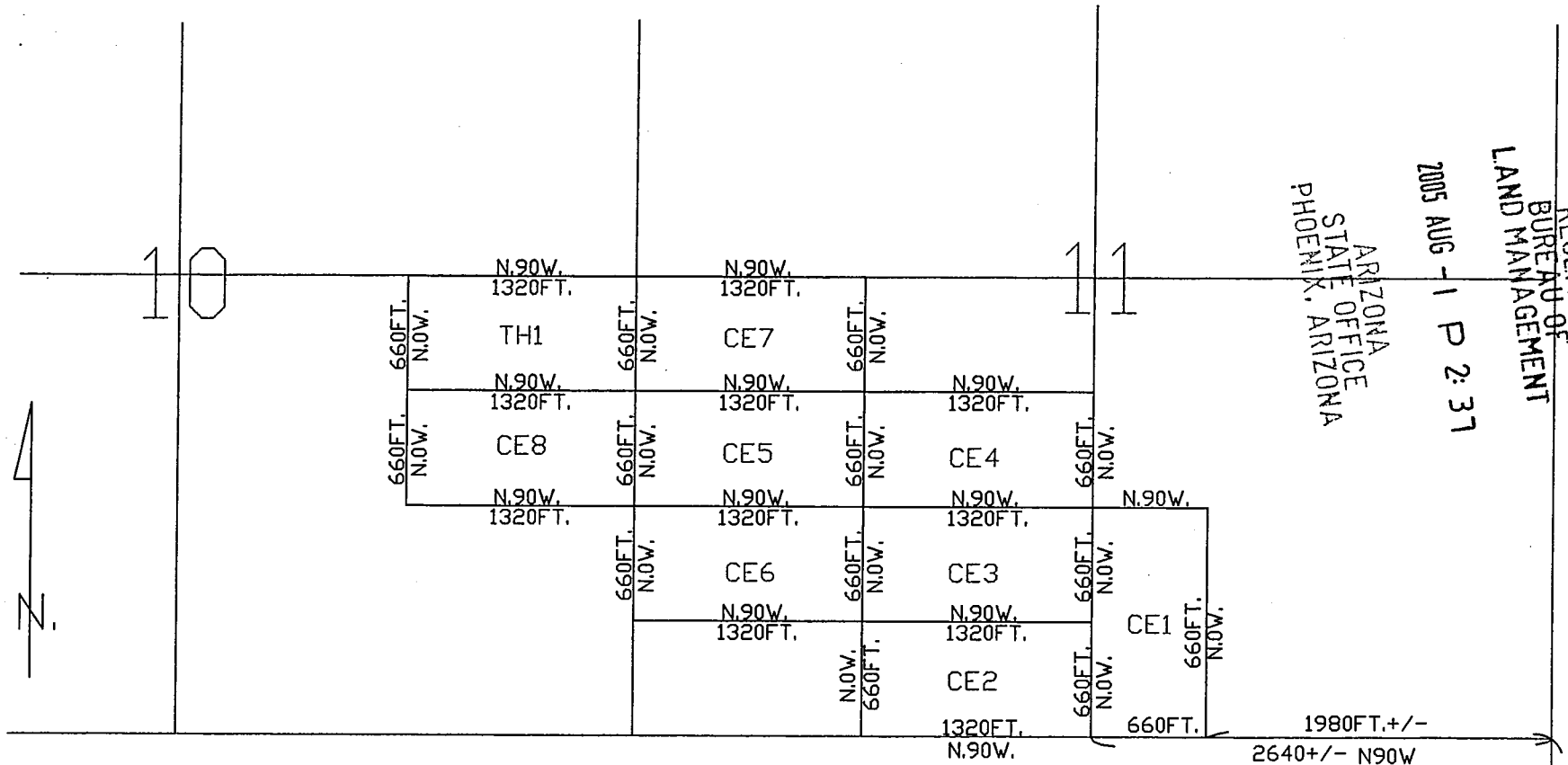

RECEIVED  
 BUREAU OF  
 LAND MANAGEMENT  
 ARIZONA  
 STATE OFFICE  
 PHOENIX, ARIZONA  
 2005 AUG - 1 P 2:37

## KEY

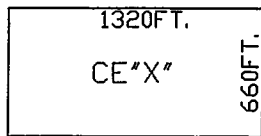

CONCENTRIC ENERGY  
PLACER CLAIMS

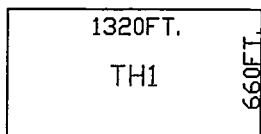

CONCENTRIC ENERGY  
PLACER CLAIMS

PLOT SCALE 1"=1000'

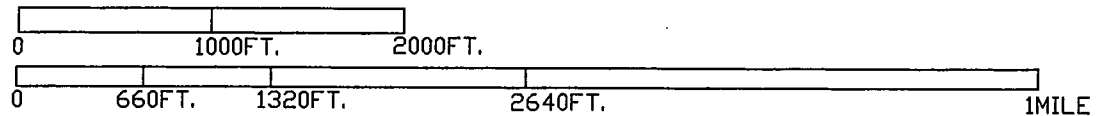

-/+0825  
 N.0W.

**Input Parameters for Geographic Report with Land**

**System Id = CR**

**Admin State = AZ**

**Geo State =**

**Casetype begins with**

**Case Disp Txt = AUTHORIZED, PENDING**

**Mer Twp Rng = 14 0110N 0100W**

**Mtrs =**

**Commodity =**

**Pending Org =**

**Section = 010, 011**

**Total Rows Returned: 1**

RUN TIME: 09:21 AM

UNITED STATES DEPARTMENT OF INTERIOR  
BUREAU OF LAND MANAGEMENT  
GEOGRAPHIC REPORT WITH LAND  
Sorted by Serial Number

RUN DATE: 08/12/2005  
Page 1 of 1

Serial Number: AZA 025475  
Total Case Acres: 129,800.000

<u>Casetype</u>	<u>Case Disp</u>	14	0110N	0100W	<u>Sect</u>	<u>Sur Typ</u>	<u>Sur Num</u>	<u>Suff</u>	<u>Subdivision</u>	<u>Act Pend</u>
231106	AUTHORIZED				010	FF			PART N2NW,W2W2SWNW;	

